

COMPACT 2 COMPACT 2 Mammo

Automated X-ray film processor

Model/ID: 119x-x-x000
Basic UDI-DI: 426050264A003UE

Instructions for use

Ident. no. 5190-0-0002



**NOTE**

All sheets of this document contain proprietary and confidential information of PROTEC X-ray Systems GmbH and is intended for exclusive use by current PROTEC X-ray Systems GmbH customers. Copying, disclosure to other or other use is prohibited without the express written authorization of PROTEC's law department. Report any violations of this requirement to PROTEC X-ray Systems GmbH.

© 2025 PROTEC X-ray Systems GmbH, Oberstenfeld

Comments and questions about the documentation please contact:

PROTEC X-ray Systems GmbH

In den Dorfwiesen 14, 71720 Oberstenfeld
Germany

Tel: (+ 49) 7062 – 92 55 0

Fax: (+ 49) 7062 – 92 55 60

E-Mail: protec@protec-med.com

Internet: www.protec-med.com

Table of contents

	Page
Table of contents	3
Revision Status	6
General Notes	7
Mechanical and Electric Warning	7
To the User	7
1 Device Description	9
1.1 Introduction	9
1.2 Description.....	9
1.2.1 Versions	9
1.2.2 Installation	9
1.3 Performance Characteristics	10
1.4 Intended Use	10
1.5 Clinical Benefit	10
1.6 Patient Target Group(s).....	10
1.7 Medical Conditions to be diagnosed.....	10
1.8 Indications and Contraindications	11
1.8.1 Indication.....	11
1.8.2 Contraindication.....	11
1.9 Intended User Group.....	11
1.10 Declaration of Conformity.....	11
2 Safety Instructions	12
2.1 General Safety Instructions.....	13
2.1.1 Requirements for Operation	13
2.1.2 Device Operation	13
2.1.2.1 Operating Type	13
2.1.3 Operating Personnel	14
2.1.4 Ventilation.....	14
2.1.5 Explosion Protection	14
2.1.6 Interaction with Other Devices.....	14
2.1.7 Electromagnetic Environment and influencing of Devices	14
3 Control Elements and Displays	15
3.1 Main switch of the automated X-ray film processor.....	15
3.2 Control Elements and Displays of the automated X-ray film processor.....	15
3.2.1 Standard Controls and Displays	15
4 Handling	16
4.1 Operation of the automated X-ray film processor.....	16
4.1.1 Before starting.....	17
4.1.2 Working procedure.....	17
4.1.3 After work.....	17
4.1.4 Stand-by mode.....	17
4.1.5 Switching on the device.....	17
4.1.6 Automatic mode	17
4.1.7 Anti-crystallization function.....	18
4.1.8 Time replenishment	18
4.1.8.1 Setting of the time replenishment.....	18
4.1.9 Working parameters.....	18
4.1.9.1 Display working parameters	18
4.1.9.2 Setting working parameters.....	18
4.1.10 Processing time	18
4.1.11 Developer temperature.....	19
4.1.12 Dryer temperature.....	19
4.1.13 Replenishment time	19

4.1.14	Dimmer function of display	20
4.1.14.1	Changing the intensity of the display	20
4.1.15	Machine cover safety disconnection	20
4.1.16	Auto fill function	20
4.1.16.1	Starting up the auto fill function	20
4.1.16.2	Manual cancellation of the auto fill function	21
4.1.17	Manual mode	21
4.1.17.1	Switching to manual mode	21
4.1.17.2	Switching back to automatic mode	21
4.1.17.3	Manual starting and stopping the film transport	21
4.1.17.4	Manual replenishment	21
4.1.18	Use of memory function	21
4.1.18.1	Store processing parameters	21
4.1.18.2	Recall processing parameters	21
4.1.18.3	Leave memory mode without change	22
4.1.19	Lock function	22
4.1.19.1	Activating and de-activating of the input lock	22
4.1.20	Stop film transport	22
4.1.21	Infrared sensitive materials	22
4.1.22	Automatic cooling function	22
4.2	Removal and installation of Dryer Rack (two-parts)	23
4.2.1	Removal	23
4.2.2	Installation	23
4.3	Function of the automated X-ray film processor	24
4.3.1	Switching the automated X-ray film processor on and off	24
5	Safety and Maintenance	25
5.1	Introduction	25
5.2	Reusability	25
5.3	Cleaning and Disinfecting	25
5.3.1	Cleaning	25
5.3.2	Daily cleaning	25
5.3.3	Weekly cleaning	26
5.3.4	Thorough cleaning every 3 months	26
5.3.5	Not in operation for 2 weeks or longer	27
5.4	Inspection and Maintenance	27
5.4.1	Daily Monitoring before and during the Examination Operation	27
5.4.2	Regular Monitoring	27
5.4.3	Maintenance	27
5.4.4	Warranty	27
5.4.5	Product Service Life	28
5.4.6	Further information	28
5.4.7	Disposal Notes	28
6	Power Supply	29
6.1	Electrical Connection	29
6.2	Protection Class	29
6.3	Power Consumption	29
7	Technical Data	30
7.1	Dimensions	31
7.2	Protection Type and Protection Class	31
7.3	Environmental Conditions	31
7.3.1	Environmental Conditions during Operation	31
7.3.2	Environmental Conditions for Shipping and Storage	31
8	Description of Symbols, Labels and Abbreviations	32
8.1	Symbols	32
8.2	Type Label	33
8.3	Labels	33
8.4	Positioning of the Symbols and Labels	35

8.5 Abbreviations35

**NOTE**

The information contained in this document conforms to the configuration of the equipment as of the date of manufacture. Revisions to the equipment subsequent to the date of manufacture will be addressed in service updates distributed to the PROTEC Technical Service Organization.

Revision Status

Revision	Date	Updated pages	Comment	Author
4.0	13/11/2018	all	new pumps, new document layout	
5.0	22/05/2019	15, 22, 60,	Room drawing new, warning hot air new, at 50Hz change to 11A at 60Hz change to 13A change power consumption to max.	
5.1	18/06/2019	60	change power consumption change to 2.8	
6.0	2021-05-25	all	V5.1 transferred to new layout (MDR)	MB
7.0	2023-06-28	Chap. 4.1.13	Listing updated	ML
8.0	2025-02-19	Chap. 5.3.3	Securing latch blue deleted	ML
9.0	2025-07-16	All	First edition PROTEC X-ray Systems GmbH	ML

General Notes



WARNING!

In order to maintain the set and tested requirements of the 60601 series of standards, the ME system must not be modified during its actual operating life.

Mechanical and Electric Warning



WARNING!

All moving parts of the equipment should be operated with care. They must be inspected and maintained regularly and in accordance with the manufacturer's recommendations contained in the accompanying documents.

Only personnel authorized by PROTEC X-ray Systems GmbH may carry out maintenance and repair work. Touching live parts and connections can be fatal.

To the User



NOTE

The user of these accompanying documents is required to carefully read and consider the instructions, warnings and cautions contained therein before beginning operation.

Even if you have already operated similar equipment, the equipment described here may nevertheless have undergone changes in design, manufacture and functional sequence which have a considerable influence on operation.

Assembly and customer service work on the system described here must be carried out by the authorized and qualified personnel of PROTEC X-ray Systems GmbH. Assembly personnel and other persons who are not employees of the Technical Service Department of PROTEC X-ray Systems GmbH are requested to contact the local branch office of PROTEC X-ray Systems GmbH before starting any assembly or service work.

For assembly and service work, it is necessary to use the "Technical Description" of the Product and to observe the points contained therein.

Even if the product has been the subject of a hazard analysis and the design corresponds to the current state of the art, residual risks remain during clinical use. These are illustrated in the following instructions for use by application limits, warnings and precautions.

Assembly and customer service work on the X-ray film processor described here must be carried out by the authorized and qualified personnel of PROTEC X-ray Systems GmbH. Assembly personnel and other persons who are not employees of the Technical Service Department of PROTEC X-ray Systems GmbH are requested to contact the local branch office of PROTEC X-ray Systems GmbH before starting any assembly or service work.

**NOTE**

The use of the product with attachments or accessories not authorized by PROTEC or other non-approved components is not permitted.

**NOTE**

According to Regulation (EU) 2017/745 on medical devices, all serious incidents that have occurred in connection with the device must be reported to the manufacturer and the competent authority of the Member State in which the user and/or patient is resident.

1 Device Description

1.1 Introduction

These instructions for use describe the performance characteristics and operation required for efficient and effective handling of the automated X-ray film processor.

Before working with the automated X-ray film processor, the complete operating instructions must be read, in particular the safety instructions and the chapter Handling.



NOTE

The instructions for use are fully valid for **all** model variants of the automated X-ray film processor described.

1.2 Description

The automated X-ray film processor is a laboratory device used for automatic development of X-ray films in human medicine.

The device is equipped with a precise roller transport system that can process sheet films.

Automatic film acquisition starts as soon as a film is fed into the feeder.

The film materials are developed, fixed, watered and dried.

With the easy-to-use microprocessor control, processing conditions can be adjusted to suit a wide variety of films and chemicals.

The developer and fixing solutions are temperature controlled, circulated and automatically replenished.

This instructions for use provide important information on the installation, operation and maintenance of the unit. Please follow the instructions given carefully to ensure reliable operation of your automated X-ray film processor.

1.2.1 Versions

COMPACT 2, 220-240V, 50 Hz

COMPACT 2, 220-240V, 60 Hz

COMPACT 2 Mammo, 220-240V, 50 Hz

COMPACT 2 Mammo, 220-240V, 60 Hz

Optional accessories

The following optional accessories are available for the automated X-ray film processor:

- Open working table COMPACT 2 1190-0-0010
- Close base cabinet 1190-0-0011

1.2.2 Installation



NOTE

The installation of the automated X-ray film processor must be performed by PROTEC Customer Service or a service authorized by it.

The automated X-ray film processor is intended for operation in a darkroom or in premises specially darkened for this purpose.

For detailed information, please refer to the installation instructions of the automated X-ray film processor.

Contact information of persons qualified by designation of the manufacturer to perform the installation is available upon request from:

PROTEC X-ray Systems GmbH

Germany

In den Dorfwiesen 14, 71720 Oberstenfeld

Telephone: +49 (0) 7062 – 92 55 0

Fax: +49 (0) 7062 – 92 55 60

E-Mail: protec@protec-med.com

Internet: www.protec-med.com

1.3 Performance Characteristics

- Extremely high capacity
- Intermediate film rinse avoids carryover of chemicals
- Precise film surface detection for calculation of replenishment rate
- Excellent image quality and consistency

1.4 Intended Use

The automated X-ray film processor is intended for automatic development of X-ray films in human medicine.

1.5 Clinical Benefit

The clinical benefit of using X-ray film processors is the development of X-ray films into two-dimensional X-ray images for creation or specification of findings as a basis for treatment decisions.

In analog X-ray diagnostics, X-ray film processing plays a very important role and makes an essential contribution to the application of this procedure. After the human body and the X-ray films have been irradiated, the X-ray film is generated with the aid of chemicals. Only after X-ray film generation, the X-ray films can be used for examination or diagnosis. Therefore, for the X-ray film processors, the general clinical benefit is valid for analog conventional X-ray examinations within the intended use.

1.6 Patient Target Group(s)

As X-ray film processors are not intended for use on patients, no intended patient group can be identified for them.

The intended patient group for a diagnostic X-ray imaging in human medicine includes all people for whom a justifying indication for a medical X-ray has been given by a physician with the necessary expertise in radiation protection.

There are no general or fundamental restrictions on the patient group regarding age, gender, origin and patient condition.

1.7 Medical Conditions to be diagnosed

Conventional X-ray images can be used to diagnose medical conditions.

A complete list of medical conditions to be diagnosed is not feasible, as the range of conventional radiographs is very diverse and may also vary in the course of medical-technical progress.

Examples for medical conditions to be diagnosed are:

- Bone fracture or bony injuries of the skeletal system or pathological changes of the bony tissue.
- Control of the correct set-up of the fracture.
- Luxation and bony ligament tears of the musculoskeletal system.
- Degenerative, inflammatory, traumatic and tumorous diseases and changes of the musculoskeletal system.
- Deformities and defective positions of the skeletal system.
- Thoracic and pulmonary symptomatology (thorax exposures).
- Sclerosis.

- Inflammatory and expansive processes of the mucous membrane, craniofacial bones and the expansion of the paranasal sinuses.
- Disease of the abdominal cavity (e.g., acute abdomen, abdominal overview radiograph, urethrogram, cystogram).

1.8 Indications and Contraindications

1.8.1 Indication

As X-ray film processors have no intended main effect in or at the human body, no indications can be shown for them.

The indication for diagnostic X-ray imaging in human medicine is always given when the patient derives a benefit from X-ray diagnostics that outweighs the radiation risk (justifying indication).

1.8.2 Contraindication

As X-ray film processors have no intended main effect in or at the human body, no contraindications can be shown for them.

There are no absolute contraindications for diagnostic X-ray imaging in human medicine.

However, only medically indicated radiographs may be performed on individuals.

For pregnant women and children, strong consideration must be given to whether a radiograph is necessary. If possible, it should be avoided.

1.9 Intended User Group

X-ray film processors are intended exclusively for use by professional users who are trained in the proper handling, use and operation as well as in the permitted conjunction with other medical products, objects and accessories.

Appropriate users can be, for example: X-ray technicians, X-ray assistants, medical technical X-ray assistants, surgeons, casualty surgeons, orthopaedists and other trained medical personnel.

1.10 Declaration of Conformity



This product complies with the requirements of Regulation (EU) 2017/745 of the European Parliament and of the Council of 5 April 2017 concerning medical devices, including all applicable corrigenda.

The declaration of conformity is available on request from:

PROTEC X-ray Systems GmbH

Germany

In den Dorfwiesen 14, 71720 Oberstenfeld

Telephone: +49 (0) 7062 – 92 55 0

Fax: +49 (0) 7062 – 92 55 60

E-Mail: protec@protec-med.com

Internet: www.protec-med.com

2 Safety Instructions

**NOTE**

Contains information that are relevant to the usage.

xxx

**CAUTION!**

Contains information that can cause damage to properties at non-conformity.

xxx

**WARNING!**

Contains information that can cause personal injuries at non-conformity.

xxx

Settings and calibrations not described in these operating instructions must be carried out based on the technical description of the device by PROTEC customer service or a service authorized by it.

**NOTE**

All instructions supplied with the automated X-ray film processor must be observed and any safety instructions contained therein must be carefully read and adhered to.

**NOTE**

After the initial installation, the commissioning must be logged with "Default function test".

**NOTE**

The X-ray film processors may only be commissioned if all safety measures for operator protection have been met and checked. These protective measures can include door contact, designated area, dosimeter, protective clothing, etc.

**CAUTION!**

The instructions for use contain all the information relevant to safety in order to generally put the X-ray film processor into operation. The device may only be operated by appropriately trained and trained personnel. In this context, operation is ensured by clear symbols on the control elements. All further information and instructions can be found on the supplied data carrier (USB, CD or DVD). This information applies in its entirety as an appendix to these instructions for use and must be observed.

**NOTE**

All control elements are described again in detail in these instructions for use.

2.1 General Safety Instructions

2.1.1 Requirements for Operation

To ensure safe operation of the automated X-ray film processor, it must be installed and operated in accordance with the information provided in this instruction for use, technical description and installation instructions.



NOTE

The automated X-ray film processor is suitable for all common types of film and chemicals that comply with the relevant specifications.
Developing and fixing solutions must be handled according to the manufacturer's instructions.
The chemical type is to be used according to the specifications of the film manufacturer.



WARNING!

The chemicals are corrosive in undiluted state. Therefore, avoid skin contact and wear suitable protective clothing such as goggles and gloves when working with the chemicals.



WARNING!

Inhalation of chemical vapors can be harmful and must be avoided. For this reason, sufficient ventilation must be ensured at the installation site.



WARNING!

If chemicals get into the eyes, rinse immediately with cold running water for approx. 15 min and consult a doctor immediately afterwards.

The environmental regulations concerning the deposit and disposal of used chemicals are to be inquired at the responsible water management offices and to be observed.

Before opening the device, it must be de-energized by disconnecting the power plug. Service and repair work may only be carried out by trained specialist personnel. Only original parts are to be used as spare parts.



WARNING!

**Protection class I device (according to EN 60601-1).
To avoid the risk of electric shock, this device may only be connected to a supply network with a protective earthing conductor.**

2.1.2 Device Operation

In case of a malfunction, do not use the X-ray film processor anymore and notify PROTEC service department or a service company authorized by them.

2.1.2.1 Operating Type

This device is intended for continuous operation.

2.1.3 Operating Personnel

**NOTE**

Only trained and authorized personnel are allowed to work on the automated X-ray film processor.

**NOTE**

The operating personnel must be familiar with all warning signs attached to the X-ray film processor. They are used for your own safety and that of others and ensure proper operation.

2.1.4 Ventilation

**WARNING!**

Inhalation of chemical vapors can be harmful to health and must be avoided. For this reason, sufficient ventilation must be ensured at the installation site.

2.1.5 Explosion Protection

The automated X-ray film processor is not designated for use within areas with explosive hazards.

2.1.6 Interaction with Other Devices

Interactions with other devices are not known.

2.1.7 Electromagnetic Environment and influencing of Devices

Equipment affected by electromagnetic interference is not known.

The automated X-ray film processor is intended for use in an environment in professional healthcare facilities (e.g., clinics, surgery centers, physiology practices ...).

3 Control Elements and Displays

3.1 Main switch of the automated X-ray film processor

The automated X-ray film processor is switched on or off by the main switch. Underneath the control panel.



3.2 Control Elements and Displays of the automated X-ray film processor

3.2.1 Standard Controls and Displays

- 1 Display working parameters
- 2 Arrow button „Up“ = increase parameter value
- 3 Arrow button „Down“ = decrease parameter value

Mode Buttons

- 4 Processing time in minutes
- 5 Developer temperature in °C
- 6 Dryer temperature in °C
- 7 Developer replenishment time in seconds
- 8 Fixer replenishment time in seconds

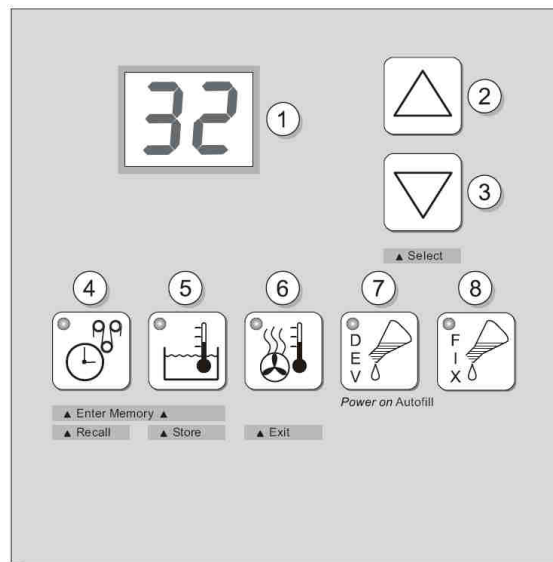

NOTE

Safety function stops film transportation when cover is removed.
Therefore, keep cover placed on the machine when processing films.

4 Handling



CAUTION!

During start-up and each time the automated X-ray film processor is refilled, check the function of the circulation pump and, if necessary, vent the circulation pumps. See installation instructions.



CAUTION!

Never operate the machine without liquid.



CAUTION!

Do not place any objects on the device.



NOTE

High or low room temperature can affect the functionality of the X-ray film processor. If the ambient temperature exceeds the set bath temperature, the image quality may deteriorate.



WARNING!

Hot air may escape when opening the lid of the film inlet!
Surface film feed tray (sheet) can be hot!

4.1 Operation of the automated X-ray film processor

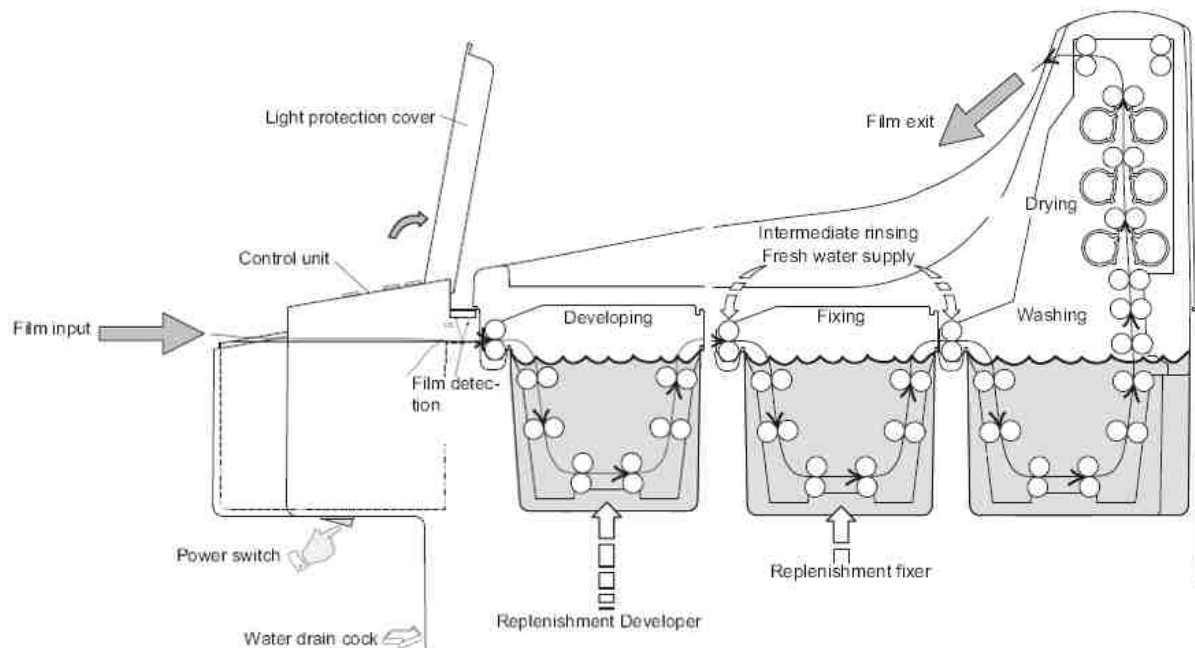

4.1.1 Before starting

- 1 Close water-drainage stop cock
- 2 Open water tap
- 3 Switch processor on
- 4 Check liquid level in replenishment and drainage collecting containers
- 5 Wait for the end of the start process or the developer temperature is reached
- 6 Run cleaning films through processor

4.1.2 Working procedure

- 7 Processing films:
Open light protection cover. Important: Put film first on left side of infeed tray and then feed in. During processing films please watch the display „-“.



NOTE

Put the film first on left side of infeed tray and then feed in.



CAUTION!

During processing films note the display „Infeeding film“

4.1.3 After work

- 8 Switch processor off
- 9 Close water tap
- 10 Open water-drainage stop cock and drain water out of the machine

4.1.4 Stand-by mode

When no film is being processed, the machine switches to Stand-by. The chemicals remain at a constant temperature. The film transport and water inflow activate at intervals to avoid crystallization of the chemicals on the transport rollers. Entry of the next film is possible at any time.

4.1.5 Switching on the device

Before switching the machine on, open the fresh water tap and close the water drainage tap (under control panel). Then switch the machine on (main switch is situated under the control panel). Once the machine is switched on, a “Start-cycle” of eight minutes duration is activated: A replenishment cycle is carried out, the water tank fills automatically and the chemical baths heat up. During this “Start-cycle” no films can be fed into the machine. The display shows two bars “– –” when the processor is not ready and no films can be fed in. This is the case during the “start cycle” and also when the baths have not reached the temperature. Until the developer temperature is not reached, the developer temperature button (5) is flashing. It is possible that the chemical bath has not reached the required temperature even after the “Start-cycle” has been completed. You need to wait until the developer temperature is reached, before inserting films. Wait until the bars “– –” disappear from the display.

4.1.6 Automatic mode

After completion of the “Start-cycle” and after a film-processing, the machine automatically goes into the stand-by mode. In the stand-by mode the processor can be started at any time by placing a film into infeed tray. Note that films can only be processed when the developer temperature is reached. When the display shows two bars “– –” no films can be fed into the machine. The temperature in the bath is too high or too low. However, when a film was fed into the machine, two bars with decimal points “-. -”. To avoid a jamming of films, wait before feeding the next film in until this display disappears (which is also signalled by an acoustic sound).

A film in the infeed-tray is registered by the light barrier and the machine starts up. The film is pulled into the machine and transported through the developer, fixer and water baths. The remaining time of processing i.e., until the film finally leaves the machine is displayed, when no more film is in the infeed-tray and the processing time button was pressed. Each working-parameter can be called up on the display by pressing the respective mode-button, however, during processing, parameters cannot be

altered. The temperatures of the developer and dryer are automatically regulated. The replenishment rate of developer and fixer chemicals is activated according to the processed film-surface (film-surface measurement). Before a film is passed on from the developer bath into the fixer bath, it is rinsed with clean water which minimises pollution of the fixer chemicals with developer chemicals. The film is then dried in the dryer before passing out of the machine and falling into the catch tray. The machine then goes into the stand-by mode. To keep the machine in working condition during the stand-by mode, the electronics have been furnished with two specialities: The anti-crystallization Function and the Time Replenishment.

4.1.7 Anti-crystallization function

During the stand-by mode, the film transport, the dryer ventilation and the water inflow are activated every 20 minutes for a period of 15 seconds. This prevents the build-up of crystals on the rollers. This function cannot be switched off.

4.1.8 Time replenishment

Also during the stand-by, the developer chemicals are subject to change which causes their deterioration. By means of the time replenishment, a replenishment cycle is activated after a set time. With this function, the quality of the developer chemicals are maintained even when standing idle for long periods. The setting-range for the time-replenishment is from 5 up to 99 minutes. When "0" is set, the time-replenishment is de-activated.

4.1.8.1 Setting of the time replenishment

- 1 Switch processor off
- 2 Press the buttons processing time (4) and replenishment time (7) simultaneously and keep pressed
- 3 Switch the machine on again and release the pressed buttons
- 4 Select the replenishment interval time (min.) by pressing the arrow buttons (2 and 3). The arrow up button (2) increases and the arrow down button (3) decreases the value
- 5 Switch processor off again

Example: At the setting "45" a replenishment cycle is activated every 45 minutes.

4.1.9 Working parameters

The processing machine develops, fixes, rinses and dries the film materials automatically. The film and chemical requirements can be adjusted accordingly and stored in the control unit.

4.1.9.1 Display working parameters

- 1 Switch processor on
- 2 Press the respective mode button (4-8) and keep pressed to display the required working parameter or press the respective mode button (4-8) and release to display the momentary value.

4.1.9.2 Setting working parameters

- 1 Switch processor on
- 2 Machine must be in the stand-by mode and no film must be in the processor
- 3 Press the respective mode button (4-8) and keep pressed: The display shows the set working parameter
- 4 Change the value by means of the arrow button (2 and 3) until required value appears on the display. The upward arrow button (2) increases and the down arrow button (3) decreases the value
- 5 Release the mode button

4.1.10 Processing time

The processing time is the time, it takes the front end of a film from the infeed of the processor until it reaches the film exit. The processing time is set by the speed with which the film is transported through the machine. Depending on the requirements, this time can be varied from 1 to 5 minutes adjusted in 0.1-minute-steps (adjusting the processing time: see 4.1.9 "Working parameters").

Processing and developer time relation		
Processing time (min)	Developer time (s)	Infeed speed (cm/min)
1,0	14	151
1,5	21	101
2,0	28	76
2,5	35	60
3,0	43	50
3,5	50	43
4,0	57	38
4,5	64	34
5,0	71	30

4.1.11 Developer temperature

The developer temperature of the different film-materials depends on the developing time. The faster a film must be developed, the higher the temperature must be. The developer temperature can be set between 26-40 °C according to the individual requirements (setting the developer temperature: see "4.1.9 working parameters"). If the temperature is lower or higher than the set value, then the bath temperature button (5) is flashing and the display shows two bars "-- --". Before feeding a film into the machine, wait until the temperature has been reached and the displayed bars "-- --" disappear.

The following chart demonstrates guide value relations between developer temperatures and processing times. Variations are possible depending on the various films and chemicals.

Processing time and developer temperature relation	
Total processing time (min(s))	Developer temperature (°C)
1,0	34 - 36
2,0	32 - 34
3,0	30 - 32
4,0	29 - 30
5,0	28 - 29

4.1.12 Dryer temperature

The dryer temperature can be adjusted within a range of 35-70 °C according to the different film-materials. To avoid dryer spots on the film, the dryer temperature may not be set too high. Adjust the temperature so that the film just gets dry (setting the dryer temperature: see "4.1.9 Working Parameters").

Remark: Depending on mains voltage dryer temperatures above 65°C may under certain circumstances not be reached.



CAUTION!

High or low room temperature can influence the function of the film processor. If the ambient temperature exceeds the set bath temperature, the image quality may deteriorate.

4.1.13 Replenishment time

The replenishment of the developer and fixer chemicals is automatic. By means of the light barrier electronic at the film-infeed, the surface of the processed films is calculated and after 0.25 m² a replenishment cycle is automatically activated. The replenishment quantity can be adjusted varying for developer and fixer by adjusting the replenishment time. The replenishment time may be set in a range of 0-60 s.

The chart below shows the replenishment time to be set for the requested replenisher rate per m²-film surface. The standard setting is 10 sec. with 500 ml replenisher rate per m² film surface. The replenisher rate must be adjusted depending on film material, chemicals and film throughput.

Relation of replenishment time and replenisher volume		
Replenisher volume (ml/m²)	Replenishment time(s)	Replenishment rate (ml per cycle)
212	4 (4)	53
320	6 (5)	80
428	8 (7)	107
532	10 (9)	133
692	13 (11)	173
800	15 (12)	200
908	17 (14)	227
1012	19 (16)	253
1120	21 (18)	280



NOTE

Values in brackets for 60Hz power connection.
Values when pump is set at 100% pump capacity.

4.1.14 Dimmer function of display

With the dimmer function the intensity of the control panel display can be changed. The intensity can be reduced to avoid possible exposure of high-sensitive films. Normal-sensitive films are not affected by the display.

4.1.14.1 Changing the intensity of the display

- 1 Switch processor on
- 2 Press arrow „down button“ (3) for about 5 seconds. The intensity changes. Two intensity-levels are available, bright and dark. During film-throughput this function is not available.

4.1.15 Machine cover safety disconnection

The machine cover may only be removed for service and maintenance purposes. The processor cannot be started without the cover. In the event that the machine cover is removed during film-throughput, the film transport will be stopped. On the display the error message “E1” will be displayed. The error will be reset when the machine cover has been replaced.

4.1.16 Auto fill function



In case new chemicals must be filled into the processor (after installation, tank cleaning), the tanks can be filled automatically by means of the autofill function. In the process, the tank is filled for a fixed period of 17 minutes, that is, chemicals are pumped from the replenishment containers to the tanks. Also the water bath will be filled (8 min. period). The display will show two symbolized tanks. When the autofill function has been completed, the machine enters the stand-by mode. In the event of the respective baths being full before the time is up, the autofill function can be manually stopped.

4.1.16.1 Starting up the auto fill function

- 1 The chemicals containers need to be filled manually with at least 1.0 litres of fresh chemicals, to ensure the pumps will not run dry!
- 2 Switch processor off

- 3 Filling developer *and* fixer tank: Keep both replenishment buttons for developer (7) and fixer (8) pressed down and switch the machine on *or* filling developer *or* fixer tank: Keep respective replenishment button (7 or 8) pressed down and switch the machine on.

4.1.16.2 Manual cancellation of the auto fill function

- 1 Stop developer tank filling: Keep developer replenishment button (7) pressed down and press "arrow down" button (3).
- 2 Stop fixer tank filling: Keep fixer replenishment button (8) pressed down and press "arrow down" button (3).

The filling of the water bath will be stopped once the automatic filling of both chemicals baths has been stopped.

4.1.17 Manual mode

In the manual mode, the processor works without the light barrier. The film transport must be started and stopped manually. All the set values in the manual mode are also valid in the automatic mode. Please note that the Infeeding-film-display ("– –") is deactivated. In the Manual Mode the replenishment function does not use film surface measurement, instead it uses a standard value. In the manual mode, a replenishment cycle can also be activated manually.

4.1.17.1 Switching to manual mode

Switch the machine on. During stand-by, press the arrow-buttons "up" (2) and "down" (3) simultaneously. When in manual mode the display is flashing.

4.1.17.2 Switching back to automatic mode

In manual mode with film transport off press both arrow-buttons "up" (2) and "down" (3) simultaneously.

4.1.17.3 Manual starting and stopping the film transport

- 1 Switch to manual mode
- 2 Press the processing time button (4) – the button illuminates
- 3 Start the film transport by pressing the arrow-button "up" (2) or stop the film transport by pressing the arrow-button „down" (3)

4.1.17.4 Manual replenishment

- 1 Switch to manual mode
- 2 Press required replenishment button for developer (7) or fixer (8) – respective button illuminates
- 3 Start the replenishment cycle by pressing the arrow-button „up" (2) or cancel the replenishment cycle by pressing the arrow-button „down" (3)

4.1.18 Use of memory function

In the memory five sets of parameters can be stored and be recalled into working memory.

4.1.18.1 Store processing parameters

- 1 Set machine to preferable parameters e.g., bath temperature, processing time etc. (see manual).
- 2 Press buttons 4 and 5 "Enter Memory" simultaneously to enter the memory mode.
- 3 Use buttons 2 and 3 "Select" to select the parameter memory (P1 to P5). Inside this the parameters will be stored, old values will be overwritten.
- 4 Press button 5 "Store" to store parameters and to leave the memory mode.

4.1.18.2 Recall processing parameters

- 1 Press buttons 4 and 5 "Enter Memory" simultaneously to enter memory mode.
- 2 Use buttons 2 and 3 "Select" to select the parameter memory (P1 to P5) from which the parameters shall be recalled.
- 3 Press button 4 "Recall" to recall parameters (copy into working memory) and to leave the memory mode.

4.1.18.3 Leave memory mode without change

Press button 6 "Exit".



CAUTION!

Please note, if input is locked (via lock function), processing parameters cannot be stored - when trying to do this, an error message "LO" will be displayed. Despite locked input, the processing parameters can be recalled.



CAUTION!

Choose the same bath temperature for all stored programmes. Of course different bath temperatures can be stored too, but when changing the programme you always have to wait until the changed bath temperature is reached.

4.1.19 Lock function

To prevent unintentional change of operation parameters the input can be locked. If the input is locked any attempt to change the parameters will display an error "LO" (locked).

4.1.19.1 Activating and de-activating of the input lock

- 1 Press buttons 4 and 5 "Enter Memory" simultaneously to enter the memory mode (see diagram 3.2.1).
- 2 Press several times the button 3 "Select" until the display will show "L.0" (Lock off: input unlocked) or "L.1" (Lock on: input locked).
- 3 Now by pressing one of the buttons 4 or 5 change the display: "L.0" if you want to unlock the input or "L.1" if you want to lock the input.
- 4 To finalize the changes press button 6 "Exit".



NOTE

Even when the input lock is activated it is possible to recall (previously stored) processing parameters of the memory-function.



CAUTION!

Please note, if input is locked via lock function, then processing parameters cannot be stored - when trying to do this, an error message "LO" will be displayed.

4.1.20 Stop film transport

In a case of a film-jam inside the machine, the film transportation can be manually interrupted. To stop the film transport press both arrow-buttons (2 and 3) simultaneously.

Related topics:

See "Manual starting and stopping the film transport" in chapter 4.1.17.3. 4.1.17.3

See "Film is caught up in the racks" in the technical description.

4.1.21 Infrared sensitive materials

Infra-red sensitive film material can be processed without danger of exposure by the light-barrier.

4.1.22 Automatic cooling function

If the developer temperature exceeds the set value, the automatic cooling function will be activated. The fan runs for a fast cooling of the bath. The same happens when the temperature is decreased by pressing the arrow button.

4.2 Removal and installation of Dryer Rack (two-parts)

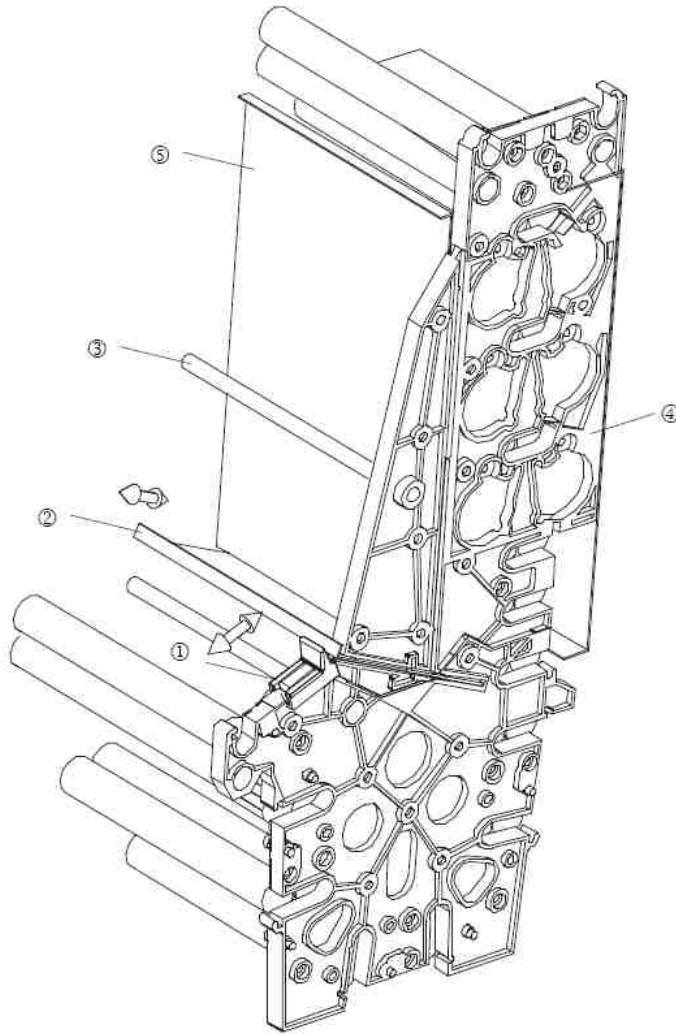

4.2.1 Removal

- 1 Push small, black slide (1) downwards.
- 2 Pull dryer plate small (2) out of the dryer.
- 3 The upper part of the dryer can now be removed. Hold the dryer at the front distance bar (3) and the whole of the metal plate in the back (4).
- 4 Take out lower part of the dryer.

4.2.2 Installation

- 1 Insert lower dryer part. Make sure that both slides at the lower part are assembled and pushed down.
- 2 Put in the upper dryer part. Insert the lower edge of the upper part carefully into the middle guidance of the lower part.
- 3 Check if side plates and gears of upper and lower part fit together correctly.
- 4 The dryer plate small (2) can now be assembled into the guidance. For this lift dryer plate large (5) a bit, so that the small plate can be pushed in, completely.
- 5 Now push both black slides (1) up until the clips click into place.

4.3 Function of the automated X-ray film processor

4.3.1 Switching the automated X-ray film processor on and off

The automated X-ray film processor is switched on or off via the device switch. Underneath the control panel.



5 Safety and Maintenance



WARNING!

Caution risk of electric shock!

Switch off the automated X-ray film processor before cleaning or disinfecting. This disconnects the automated X-ray film processor from the power source and eliminates the risk of electric shock.

5.1 Introduction

In this chapter you will find information about safety and maintenance necessary to ensure the correct and reliable operation of the device after installation.

5.2 Reusability

The automated X-ray film processor can be reused without any special reprocessing procedures.

5.3 Cleaning and Disinfecting



NOTE

Discoloration of the baths is normal due to the chemical properties and is not a defect.



CAUTION!

Do not use solvents containing alcohol when cleaning the machine.



WARNING!

Make sure that no liquid enters the inside of the housing during cleaning and disinfection to prevent electrical short circuits and/or corrosion.

Do not allow any liquids to run into the interior of the device or over the control panel. Liquids can damage the device.

5.3.1 Cleaning

Cleaning the automated X-ray film processor is very easy due to the very good quality surface coating. Generally, this is only done with a dry cloth.

Do not use any corrosive, dissolving or abrasive cleaning agents, which may damage the device surfaces or the coating.

Clean device surfaces and painted parts with a damp cloth and a mild to slightly alkaline cleaning solution (e.g., RBS® Neutral T) and wipe dry.

5.3.2 Daily cleaning

Before operation:

- Remove dirt from the film insert with a soft cloth
- Run 2 - 3 cleaning films to remove accumulated dirt and dust from the rollers
- Check the level in the regeneration tanks and refill solutions if necessary

After operation:

- After finishing work, the water must be drained from the machine. This reduces the growth of algae in the water bath.

5.3.3 Weekly cleaning



CAUTION!

Remove the water or dryer roller rack so that no water enters the air shaft.

The developer chemistry creates deposits in the machine. These deposits have a negative effect on the development process of the film material. The X-ray film processor must therefore be cleaned of these deposits at regular intervals.

Clean the roller rack every week, which takes only a few minutes.

- 1 Switch off the device and remove the cover
- 2 Open the locking mechanism of the roller racks: To do this, open the latches (red and beige) on the right side of the drive shaft.
- 3 Remove the roller packs and rinse thoroughly under warm running water and allow to drain. It is best to use a soft sponge (not a pot scrubber - this will scratch the rollers!) to remove the dirt from the rollers. The rollers can be moved by turning the drive shaft.
- 4 Dry the feed roller pair well (first roller pair of the developer).
- 5 Reinsert the roller sets: red = developer, blue = fixer, beige = washer/dryer. Make sure that they are inserted correctly and do not forget to lock the drive shaft.
- 6 Put the device cover back on and make sure that it is correctly attached.
- 7 Clean the outside of the unit with a damp cloth. Do not use harsh cleaners or solvents.

5.3.4 Thorough cleaning every 3 months

Depending on the film throughput, the machine must be thoroughly cleaned every 3 to 6 months by PROTEC customer service or a service authorized by PROTEC. Appropriate tank cleaners are available for the developer and water tanks; the fixer tank is cleaned with water only. When using chemical tank cleaners, follow the manufacturer's instructions.

Procedure

- Switch off the device and empty the tanks by opening the shut-off valves. Caution: The device will not empty if it is switched on.
- Remove the device lid and wait until the tanks are completely empty, then close the stopcocks again. Fill the fixing tank with water. Prepare the cleaners for the developer and water tanks and fill them into the corresponding tanks.
- Pull the suction tubes out of the regeneration tanks and hang them in a bucket filled with water. Caution: Do not add any chemical cleaner!
- Put on the lid and switch on the unit.
- Start film transport (see "Starting and stopping the film transport manually" in chapter 4.1.17.3) and let it run for 10 to 20 minutes. During this time, the inserted roller packs are cleaned.



NOTE

After cleaning the tank, rinse the tanks thoroughly. Fill with fresh water twice and run the machine for 10 minutes each time. Empty the tanks again and close the shut-off valves.

- Remove the roller assemblies and rinse them thoroughly under running water. Remove any remaining dirt from the rollers with a soft sponge; the rollers can be moved by turning the drive shaft. Dry the feed roller pair (first roller pair of the developer rack) thoroughly. Replace the racks.

- Fill the tanks with chemistry. This can be done manually or automatically (see "Automatic tank filling" chapter 4.1.16). Insert the suction pipes into the regeneration tanks. The circulation pump may still have to be vented (see installation instructions).
- Develop test films for quality control.

5.3.5 Not in operation for 2 weeks or longer

If the X-ray film processor is not used for more than two weeks, then the chemicals must be drained from the tanks. If you do not want to perform tank cleaning right away, then fill the tanks with water.

5.4 Inspection and Maintenance



WARNING!

No maintenance or repair work may be carried out while the X-ray film processor is in use!

All maintenance and repair work may only be carried out by PROTEC trained or authorized personnel.



CAUTION!

Never operate the machine without liquid.

5.4.1 Daily Monitoring before and during the Examination Operation

n/a. See Chapter Cleaning.

5.4.2 Regular Monitoring

n/a. See Chapter Cleaning.

5.4.3 Maintenance

PROTEC Customer Service or a service authorized by it, must carry out the required maintenance every 3-6 months, depending on the film throughput and ensure the safe reliable functioning of the X-ray film processor.

The required specifications can be found in the corresponding Technical Description in Chapter 3 *Maintenance and Safety Inspection*.

In the event that the scheduled maintenance is not carried out, PROTEC X-ray Systems GmbH accepts no liability whatsoever for damage to the user and third parties if and to the extent that damage results from inadequate or non-performed maintenance.

Prior to test operation, the user must ensure that all safety devices listed in the instructions for use are functional and that the product is ready for operation.



NOTE

Wear parts must be replaced by original components.

5.4.4 Warranty



NOTE

The current warranty conditions can be found in your order papers or in the price list valid at the time of purchase.

Repairs and spare parts are also excluded in the event of improper operation.

Warranty work may only be carried out by trained specialist personnel.

5.4.5 Product Service Life

The X-ray film processor is designed for a service life of 7 years when used as specified and regularly maintained by PROTEC Customer Service or a service agent authorized by PROTEC. After reaching the product lifetime, further use is at your own risk.

5.4.6 Further information

Detailed information on the individual chapters and on safe operation, transport and storage can be found in the Technical Description and Installation Instructions of the X-ray film processor.

5.4.7 Disposal Notes

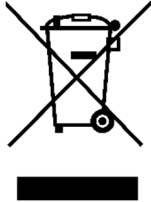

The automated X-ray film processor contains various plastics, oil and heavy metals. When disposing of replacement and spare parts as well as the entire system, the applicable rules and regulations must be observed. For this purpose, contact your contract partner or service company or commission a company specialized in the disposal of the respective components.

6 Power Supply

6.1 Electrical Connection

The electrical connection data of the device can be found on the type label.

Type 119x-1-x000

230 V ~ +/-10%, 11A, 50Hz

Type 119x-2-x000

230 V ~ +/-10%, 13A, 60Hz

Device according to IEC 1010 (EN 61010, VDE 0411) overvoltage category II.



WARNING!

To avoid the risk of electric shock, this device must only be connected to a supply network with a protective earth conductor.

6.2 Protection Class

IP 20

6.3 Power Consumption

Standby

0,23 kWh

Maximum in development mode at 230V/50Hz

2,8 kWh

7 Technical Data

Film transport	Continuous roller transport system
Film formats	In general: sheet films up to max. 45.1 cm (17.7") width; Smallest film format 10x10 cm (4x4").
Processing capacity	232 films 24x30 cm (10x12 ") per hour (standard model, film fed in crosswise, at 90sec)
Processing time	1 -5 min.; adjustable in steps of 0.1-min.
Linear speed	30 - 151 cm/min., depending on selected process time
Developer time	14 - 71 sec, depending on selected process time
Tank capacities:	12.5 l developer, 12 l fixer, 13l water
Circulation system	Developer and fixer are continuously circulated by a circulation pump
Replenishment	Automatic by film surface measurement in relation to processed film; quantity adjustable; time replenishment can be activated.
Developer temperature	Adjustable 26 - 40 °C (78.8 - 104 °F)
Fixer temperature	Adjusted to developer temperature by heat exchanger
Dryer temperature	Adjustable 35 -70C° (95-158°F), temperature achieved depends on main voltage
Water connection	Permissible water pressure 2 - 10 bar (29 - 145 psi), permissible water temperature 5 - 30 °C (41 - 86 °F)
Water consumption	1.9 litres per minute (0.5 gal/min) when processing.
Drain capacity	11 litres per minute
Noise level	Less than 59 dB(A)
Heat emission	During processing approx. 1.5kJ/s.
Pollution degree	2
Weight (processor)	Empty 77 kg/*91kg (170/*200 lbs) Filled 115 kg/*129 kg (254/*284 lbs)
Dimensions (LxWxH)	97 x 68 x 127cm (38.2x26.8x50")
Floor space required	0.67 m ² (7.2 sqft)

7.1 Dimensions

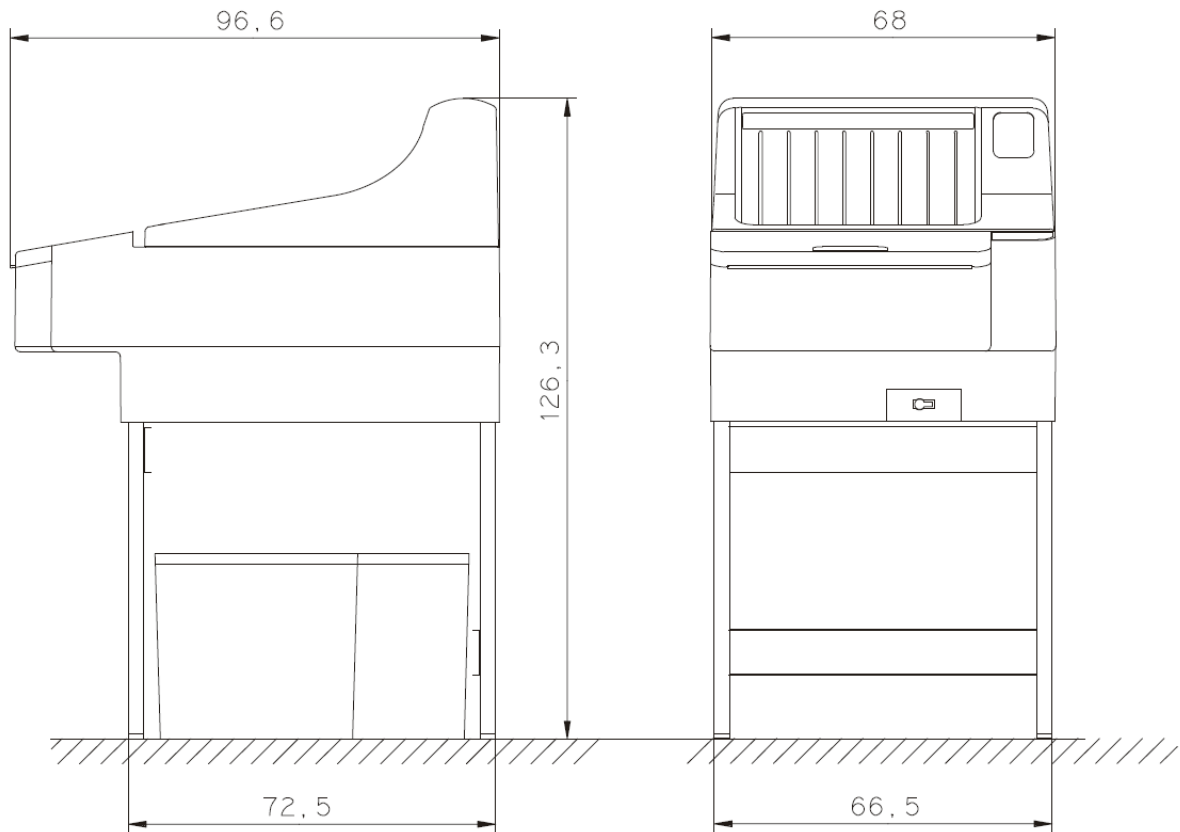

7.2 Protection Type and Protection Class

The X-ray film processor complies with protection class I.

7.3 Environmental Conditions

7.3.1 Environmental Conditions during Operation



















Usage	Only indoor (darkroom)
Surrounding temperature	18 - 40 °C (51,6 - 104 °F), ventilated room, room temperature must be lower than set bath temperature. If the ambient temperature exceeds the set bath temperature, the image quality may deteriorate.
Relative humidity	Humidity less than 80% up to 31°C (80°F), decreasing linearly to 50% at 40°C (104°F).
Air pressure	Altitude above sea level less than 2000m (6666 feet).











7.3.2 Environmental Conditions for Shipping and Storage

Surrounding temperature	- 10°C to +70°C
Relative humidity	10% to 95% (non-condensing)
Air pressure	500 hPa to 1060 hPa

8 Description of Symbols, Labels and Abbreviations

8.1 Symbols

	Atmospheric pressure limit
	Temperature limit
	Humidity limit
	Keep dry
	Fragile, handle with care
	This way up
	Attention, observe accompanying documents
	CE-marking
	Manufacturer
	Medical Device
	Order reference
	Serial number
	Unique Device Identification
	Production date
 www.protec-med.com/download	This symbol indicates the need to consult the operating instructions. This is provided in an electronic format (eIFU) on our website.
	Disposal instructions; WEEE , Waste of Electrical and Electronic Equipment
	Earth ground
	Electrical voltage warning
	Hot surface warning

	Operating parameters display
	Increase set value
	Decrease set value
	Processing time
	Developer temperature
	Dryer capacity in %
	Developer replenishment time
	Fixer replenishment time
	Replenishment
	Overflow
	Drain

8.2 Type Label

MD

REF 1190-1-1000

SN SNxxxxxx

2025-07-09

www.protec-med.com/download

+18 °C 700 hPa 80%

+40 °C 1060 hPa 50%

COMPACT 2

Automated X-ray film processor

POWER RATING

220-240	V
50	Hz
11	A

Both phases are fused!

CE

PROTEC

PROTEC X-ray Systems GmbH
In den Dorfwiesen 14
71720 Oberstenfeld
Germany

UDI



(01)04260502640524
(11)250709
(21)SNxxxxxx

TL1190-1-1000V04

8.3 Labels

Company label



Operating foil

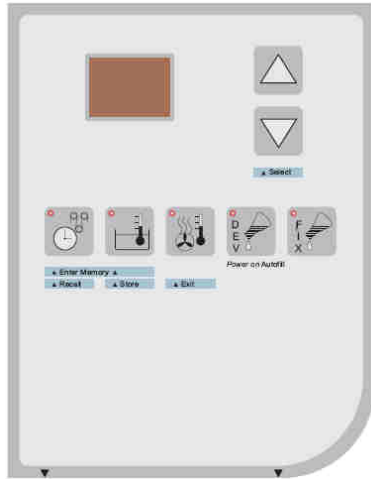

Designation hose connections

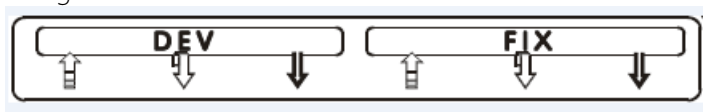

Description of the fuse

2x T / sb
10A 250V

Label water pressure

Wasseranschluß:	Zulässiger Wasserdruck 2-10 bar
Water connection:	Permissible water pressure 2-10 bar
Arrivée d'eau:	Pression nécessaire de 2 à 10 bars
Conexión de agua:	Presión admisible del agua: 2-10 bares
Conessione acqua:	Pressione ammissibile dell' acqua: 2-10

Label on the floor plate



Water outlet



Water outlet open or closed

8.4 Positioning of the Symbols and Labels

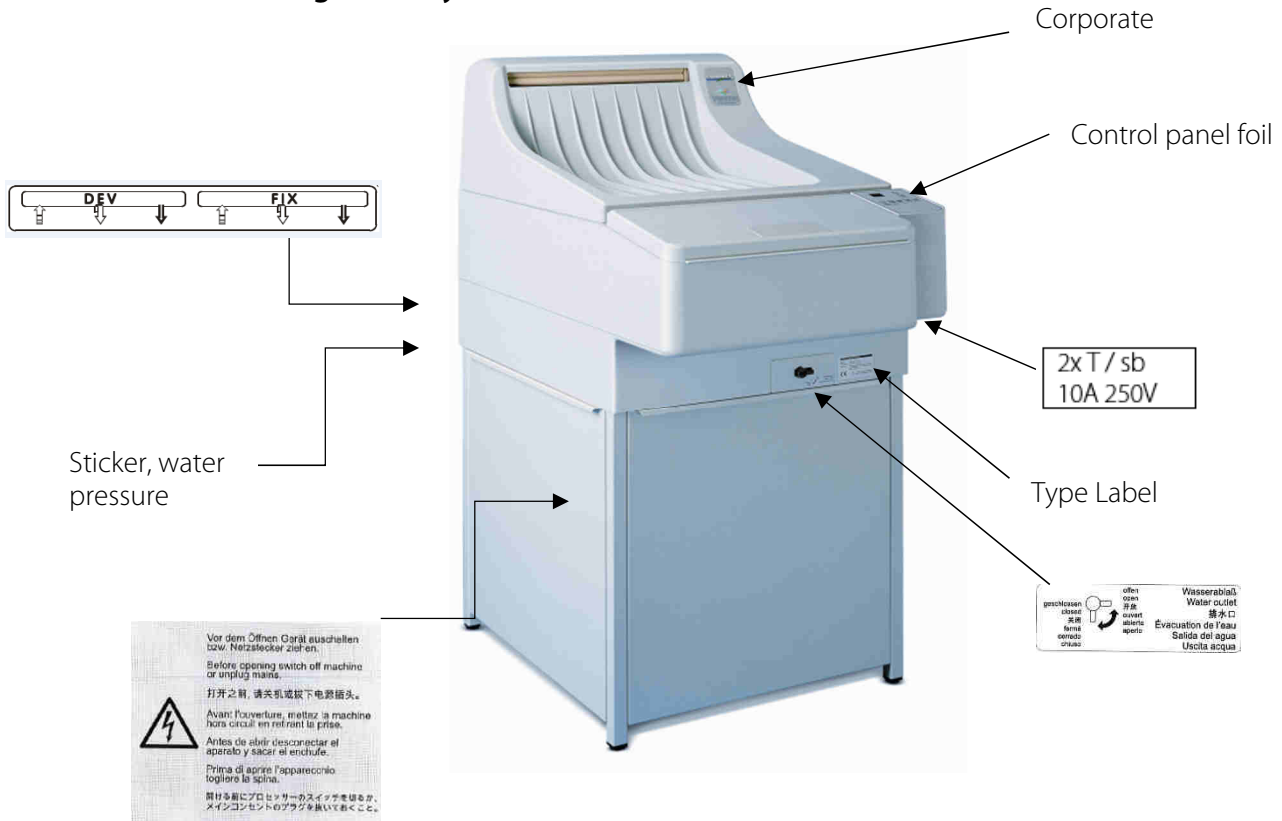

8.5 Abbreviations

mm	Millimetre
cm	Centimetre
Lb	Pound
kg	Kilogram
°C	Degree Celsius
hPa	Hectopascal
DIN	German Industry Standard
EN	European Standard
CE	CE marking
Hz	Hertz
ED	Duty Cycle
A	Ampere
SN	Serial number