

# COMPACT 2 NDT

## Automated X-ray film processor

Model/ID: 1193-x-x000

### User Manual

Ident. Nr. 5193-0-0002



Figure with processor base cabinet



**NOTE**

All sheets of this document contain proprietary and confidential information of PROTEC X-ray Systems GmbH and is intended for exclusive use by current PROTEC X-ray Systems GmbH customers. Copying, disclosure to other or other use is prohibited without the express written authorization of PROTEC's law department. Report any violations of this requirement to PROTEC X-ray Systems GmbH.

---

© 2025 PROTEC X-ray Systems GmbH, Oberstenfeld

These accompanying documents were created and distributed by the documentation department.  
Comments and questions about the documentation, please contact:

**PROTEC X-ray Systems GmbH**

In den Dorfwiesen 14 | 71720 Oberstenfeld  
Deutschland

**Phone: (+ 49) 7062 – 92 55 0**

**Fax: (+ 49) 7062 – 92 55 60**

**E-Mail: [protec@protec-med.com](mailto:protec@protec-med.com)**

**Internet: [www.protec-med.com](http://www.protec-med.com)**

## Table of contents

	Page
<b>Table of contents</b> .....	<b>3</b>
<b>Document Effectivity</b> .....	<b>7</b>
<b>General Notes</b> .....	<b>8</b>
<b>Mechanical – Electric Warning</b> .....	<b>8</b>
<b>To the User</b> .....	<b>8</b>
<b>1 Product description</b> .....	<b>9</b>
1.1 Introduction.....	9
1.2 Description.....	9
1.2.1 Installation.....	9
1.3 Product specific characteristics.....	9
1.4 Intended use.....	9
1.5 Indications, Contraindications.....	10
1.6 Intended user group.....	10
1.7 Conformity.....	10
<b>2 Safety Instructions</b> .....	<b>11</b>
2.1 General safety notice.....	12
2.1.1 Requirements for operation.....	12
2.1.2 Operating of the radiographic system.....	12
2.1.2.1 Operating type.....	12
2.1.3 Operating personnel.....	13
2.1.4 Ventilation.....	13
2.1.5 Interaction with external devices.....	13
2.1.6 Electromagnetic Environment and the influence of devices.....	13
<b>3 Installation</b> .....	<b>14</b>
3.1 Requirements for installation.....	14
3.2 Transport.....	14
3.3 Installation of processor.....	16
3.4 Levelling of processor.....	16
3.5 Connecting the processor.....	17
3.5.1 Water connection.....	17
3.5.2 Hose Connection.....	18
3.6 Initial Operation.....	19
3.6.1 Test run.....	19
3.6.2 Fill processor with chemicals.....	19
3.6.3 Mode of Operation.....	19
3.6.4 Automatic filling and heating.....	19
3.6.5 Stand-by mode.....	19
3.6.6 Film registration.....	19
3.6.7 Automatic replenishment.....	19
<b>4 Control elements and device displays</b> .....	<b>20</b>
4.1.1 Control elements and device displays standard.....	20
<b>5 Handling / Operation</b> .....	<b>21</b>
5.1 Operation.....	21
5.1.1 Before use.....	21
5.1.2 Working procedure.....	21
5.1.3 After work.....	21
5.1.4 Stand-by mode.....	22
5.2 Function of the automated X-ray film processor.....	22
5.2.1 Switching on the machine.....	22
5.2.2 Automatic mode.....	22
5.2.3 Anti-crystallization function.....	23
5.2.4 Time replenishment (Anti-oxidation function, Flood replenishment).....	23

5.2.4.1	Setting off the time replenishment.....	23
5.2.5	Working parameters.....	23
<b>5.2.5.1</b>	Display working parameters.....	23
5.2.5.2	Setting working parameters.....	23
5.2.6	Processing time.....	23
5.2.7	Developer temperature.....	24
5.2.8	Dryer temperature.....	25
5.2.9	Replenishment time.....	25
5.2.10	Dimmer Function of Display.....	26
5.2.10.1	Setting the intensity of the display.....	26
5.2.11	Machine cover Safety Disconnection.....	26
5.2.12	Auto fill Function.....	26
5.2.12.1	Starting up the auto fill function.....	26
5.2.12.2	Manual cancellation of the auto fill function.....	26
5.2.13	Manual Mode.....	26
5.2.13.1	Switching to manual mode:.....	26
5.2.13.2	Switching back to automatic mode:.....	26
5.2.13.3	Manual starting and stopping the film transport.....	27
5.2.13.4	Manual replenishment.....	27
5.2.14	Use of Memory Function.....	27
5.2.14.1	Store processing parameters.....	27
5.2.14.2	Recall processing parameters.....	27
5.2.14.3	To leave memory mode without change.....	27
5.2.15	Lock Function.....	27
5.2.15.1	Activating and de-activating of the input lock.....	27
5.2.16	Stop Film Transport.....	28
5.2.17	Infrared Sensitive Materials.....	28
5.2.18	Automatic Cooling Function.....	28
5.3	Removal and Installation of Dryer Rack (two-parts).....	29
5.3.1	Removal.....	29
5.3.2	Installation.....	30
5.4	Problems and Solutions.....	30
5.4.1	Advice on Film Defects.....	30
5.4.1.1	Films do not have enough density.....	30
5.4.1.2	Too high a density.....	30
5.4.1.3	Films will not dry.....	30
5.4.1.4	Film has a yellow-green surface.....	30
5.4.1.5	Scratches, pressure marks, dirt on film.....	30
5.4.1.6	Cloudy film.....	30
5.4.2	Advice on Machine Errors.....	31
5.4.2.1	Machine does not switch on.....	31
5.4.2.2	Rinsing water does not flow.....	31
5.4.2.3	Replenishment rate too high.....	31
5.4.2.4	Replenishment rate too low.....	31
5.4.2.5	Replenishment pump does not pump.....	31
5.4.2.6	Water tank overflows.....	31
5.4.2.7	The film does not transport correctly.....	31
5.4.2.8	Film cannot be fed, the display shows „E1“.....	31
5.4.2.9	Film is in the infeed and nothing happens.....	31
5.4.2.10	Film is caught up in the racks.....	31
5.5	Error messages.....	32
<b>6</b>	<b>Safety and Maintenance.....</b>	<b>33</b>
6.1	Introduction.....	33
6.2	Cleaning and disinfection.....	33
6.2.1	Cleaning.....	33
6.2.2	Daily care.....	33
6.2.3	Weekly Care.....	34

6.2.4	Thorough Cleaning .....	34
6.2.5	Before you go on holiday or longer than 2 weeks not use .....	35
6.3	Check-up and maintenance .....	35
6.3.1	Recommended Maintenance Work.....	35
6.3.2	Maintenance .....	36
6.3.3	Maintenance Protocol.....	37
6.4	Warranty .....	38
6.5	Product life time .....	38
6.6	Further Information.....	38
6.7	Disposal.....	38
<b>7</b>	<b>Trouble Shooting.....</b>	<b>39</b>
7.1	Algae.....	39
7.1.1	Excessive algae growth in water tank.....	39
7.2	General.....	39
7.2.1	Mains switch "ON" – no function.....	39
7.2.2	No display but circulation pumps run.....	39
7.3	Drive.....	39
7.3.1	Machine does not start automatically.....	39
7.3.2	Machine doesn't stop automatically.....	39
7.3.3	Drive motor does not run .....	40
7.3.4	Display shows error message "E2" .....	40
7.4	Baths .....	40
7.4.1	No circulation in bath.....	40
7.4.2	Developer bath temperature is not reached .....	40
7.4.3	Developer bath temperature is higher than the set temperature, display shows two crossbars, developer temperature button blinks.....	40
7.4.4	Developer bath temperature too high or too low (display shows values of 20 °C or 42 °C)	40
7.4.5	Calibration of bath temperature / actual bath temperature is different from displayed value	40
7.4.5.1	Calibration process.....	40
7.5	Film defects .....	41
7.5.1	Films will not dry.....	41
7.5.2	The film does not transport correctly .....	41
7.5.3	Scratches, pressure marks, dirt on film.....	41
7.6	Replenishment .....	41
7.6.1	Replenishment pump does not work or works insufficiently.....	41
7.7	Dryer .....	41
7.7.1	Display shows error message "E4".....	41
7.7.2	Dryer ventilation does not function, no water inflow when water cock opened.....	41
7.7.3	Dryer ventilation is too weak .....	42
7.7.4	Dryer temperature cannot be reached.....	42
7.7.5	Dryer temperature display exceeds the set value.....	42
7.7.6	Dryer temperature cannot be reached or is too high (display shows values approx. 30 °C and 75 °C)	42
7.8	Water .....	42
7.8.1	Rinsing water does not flow.....	42
7.8.2	Water tank overflows.....	42
<b>8</b>	<b>Spare Parts and schematics .....</b>	<b>43</b>
8.1	Spare Parts.....	43
8.2	Tips and Tricks.....	48
8.2.1	Removal of control PCB.....	48
8.2.2	Adjusting the software – sub-versions .....	48
8.2.3	Stop start-cycle .....	48
8.2.4	Display of machine information.....	48
8.3	Schematics.....	49
<b>9</b>	<b>Power Supply .....</b>	<b>59</b>

---

9.1	Electrical connections .....	59
9.2	System protection .....	59
9.3	Power consumption .....	59
<b>10</b>	<b>Technical specifications .....</b>	<b>60</b>
10.1	Protection Art and Protection Class .....	61
10.2	Environmental .....	61
10.2.1	Environmental conditions during operation .....	61
10.2.2	Environmental Conditions for Shipping and Storage .....	61
<b>11</b>	<b>Description of symbols, labels and abbreviations .....</b>	<b>62</b>
11.1	Symbols .....	62
11.2	Identification label .....	63
11.3	Labels .....	63
11.4	Position symbols and labels .....	65
11.5	Abbreviations .....	65

**NOTE**

The information contained in this document conforms to the configuration of the equipment as of the date of manufacture. Revisions to the equipment subsequent to the date of manufacture will be addressed in service updates distributed to the PROTEC Technical Service Organization.

**Document Effectivity**

Revision No.	Date	List of effective pages	Comments
4.0	26/11/2018	all	new pumps, new document layout
5.0	22/05/2019	15, 22, 60,	Room drawing new, Warning hot air new, at 50Hz change to 11A at 60Hz change to 13A; change power consumption to max.
5.1	18/06/2019	60	Change power consumption to 2.8
6.0	2021-11-30	60	Filmformats corrected and described in more detail.
7.0	2023-06-28	Chap. 5.2.9	Listing updated
7.1	2023-08-02	Page 47	Caution updated
8.0	2025-02-19	Chap. 6.2.3	securing latch blue deleted
9.0	2025-07-16	All	First edition PROTEC X-ray Systems GmbH

## General Notes

### Mechanical – Electric Warning

---



#### **WARNING!**

**All of the movable assemblies and parts of this equipment should be operated with care and routinely inspected in accordance with the manufacturer's recommendations contained in the equipment Accompanying Documents. Maintenance and service is only to be performed by Customers authorized by PROTEC X-ray Systems GmbH. Live electrical terminals are deadly.**

---

### To the User

---



#### **NOTE**

The user of this Document is directed to read and carefully review the instructions, warnings and cautions contained herein prior to beginning operation, installation or service activities.

While you may have previously operated equipment similar to that described in this Document, changes in design, manufacture or procedure may have occurred which significantly affect the present operation.

Although the product was subject to a risk analysis and the design corresponds to the current state of the art, residual risk will remain in clinical use. These are displayed in the following user manual by application limitations, contraindications, warnings and precautions.

The installation and service of equipment described herein is to be performed by authorized, qualified **PROTEC X-ray Systems GmbH** Customers.

Assemblers and other Customers not employed by nor directly affiliated with **PROTEC X-ray Systems GmbH** technical services are directed to contact the local **PROTEC X-ray Systems GmbH** office before attempting installation or service procedures.

---



#### **NOTE**

The usage of the product in combination with accessories which aren't authorized by PROTEC is forbidden.

---

# 1 Product description

## 1.1 Introduction

This user manual describes the special features and operational aspects of the COMPACT 2 NDT, knowledge of which are required for efficient and effective use of the radiographic system.

Prior to working with the automated X-ray film processor COMPACT 2 NDT, it is required that the user read the Safety Notes as well as the chapter regarding operation.

## 1.2 Description

The automated X-ray film processor COMPACT 2 NDT is a laboratory device used for the automatic development of X-ray films in the non-medical field, material testing.

The device is equipped with a precise roller transport system that can process sheet films. The automatic movie recording starts as soon as a film is entered into the feeder. The film materials are developed, fixed, watered and dried. With the easy-to-use microprocessor control, the processing conditions can be adapted to a wide variety of films and chemicals. The developer and fixing solutions are regulated in their temperature, circulated and automatically regenerated.

These operating instructions give you important information on the installation, operation and maintenance of the device. Please note the information given to ensure the reliable operation of your COMPACT 2 NDT.

### *Optional accessories*

The following optional accessories are available for the automated X-ray film processor

Processor base stand (open)	1190-0-0010
Processor base cabinet (closed)	1190-0-0011

### 1.2.1 Installation

See chapter 3.

Contact information's of persons which are qualified to make installations are request able at:

PROTEC X-ray Systems GmbH  
In den Dorfwiesen 14 | 71720 Oberstenfeld  
Telephone: +49 (0) 7062 – 92 55 0  
Fax: +49 (0) 7062 – 92 55 60  
E-Mail: [protec@protec-med.com](mailto:protec@protec-med.com)  
Internet: [www.protec-med.com](http://www.protec-med.com)

## 1.3 Product specific characteristics

- Extremely high capacity
- Intermediate film rinse avoids carryover of chemicals
- Precise film surface detection for calculation of replenishment rate
- Easy modification for film exit to the light area (optional)
- Excellent image quality and consistency

## 1.4 Intended use

The automated X-ray film processor COMPACT 2 is intended for the automatic development of X-ray film in the non-medical field, material testing (non-destructive radiographic tests).

## 1.5 Indications, Contraindications

As the COMPACT 2 NDT automated X-ray film processor has no intended primary effect in or on the human body (patient) but is used as laboratory equipment in a darkroom, no indications or contraindications can be identified for this product.

## 1.6 Intended user group

The automated X-ray film processor COMPACT 2 NDT is exclusively designated for use by professional who are trained, in accordance with the corresponding national regulations, in the use of diagnostic X-Ray equipment and its proper (certified) use in connection with other objects and accessories.

## 1.7 Conformity



This product is in conformity with the requirements of the European Community Medical Device Directive 2006/42/EC, including all valid amendments to the date of issue.

The declaration of conformity is available directly from PROTEC:

PROTEC X-ray Systems GmbH  
In den Dorfwiesen 14 | 71720 Oberstenfeld  
Telephone: +49 (0) 7062 – 92 55 0  
Fax: +49 (0) 7062 – 92 55 60  
E-Mail: [protec@protec-med.com](mailto:protec@protec-med.com)  
Internet: [www.protec-med.com](http://www.protec-med.com)

## 2 Safety Instructions

---

**NOTE**

Contains information that are relevant to the usage.

xxx

---

**CAUTION!**

Contains information that can cause damage to properties at non conformity.

xxx

---

**WARNING!**

Contains information that can cause personal injuries at nonconformity.

xxx

---

Adjustments and calibrations that are described within the user manual must be made, with the aid of The technical description for the system, by the **PROTEC X-ray Systems GmbH** customer service department or a PROTEC X-ray Systems GmbH authorized service technician.

---

**NOTE**

Every delivered manual has to be read and the safety notes have to be observed.

---

**CAUTION!**

**The manual contains every safety relevant information's for the commissioning of the COMPACT 2 NDT. Operating the device is exclusively for special trained staff. In this context there are on every operating element relevant safety symbols. Further information's are on the delivered document-CD. Those information's count as additional information's and have to be observed.**

---

**NOTE**

Every operating elements are descript in the corresponding manual.

---

## 2.1 General safety notice

### 2.1.1 Requirements for operation

To ensure the safe operation of this processor, installation and use should always conform to the instructions contained in this manual.



#### **WARNING!**

**Non-diluted chemicals are caustic. For this reason, chemicals should be handled very carefully. Avoid contact with skin, always wear protective clothing, gloves and glasses when handling the chemicals.**

---



#### **WARNING!**

**Inhalation of chemicals can be dangerous to your health and should be avoided. For this reason, always ensure that the room in which the processor is installed is adequately ventilated.**

---



#### **WARNING!**

**Also when taking the racks out for cleaning or servicing. In case of chemicals getting into the eyes, rinse eyes immediately with cold, running water for approximately 15 minutes, and contact a doctor afterwards.**

---

The developer and fixer chemicals used in the processor should be handled according to the manufacturer instructions. In general: Non-diluted chemicals are caustic. For this reason, chemicals should be handled very carefully. Avoid contact with skin, always wear protective clothing, gloves and glasses when handling the chemicals - for example, when mixing and refilling. Also when taking the racks out for cleaning or servicing. In case of chemicals getting into the eyes, rinse eyes immediately with cold, running water for approximately 15 minutes, and contact a doctor afterwards. Inhalation of chemicals can be dangerous to your health and should be avoided. For this reason, always ensure that the room in which the processor is installed is adequately ventilated.

Environmental regulations regarding the storage and disposal of waste chemicals should be obtained from the local water authorities and complied with.

Before opening the processor switch off the unit and unplug it from the electrical socket. Service and repairs must be performed by trained service technicians only. Use only manufacturer replacement parts.



#### **WARNING!**

**Class I ME device (according EN 60601-1).  
To reduce the risk of electric shock, this unit is designated exclusively for connection to a supply network with protective earth.**

---

### 2.1.2 Operating of the radiographic system

When having troubles with operating of the COMPACT 2 NDT, immediately call the Service of PROTEC or an authorized service and stop the using of the COMPACT 2 NDT.

#### 2.1.2.1 Operating type

The automated X-ray film processor is designated for continuous use.

### 2.1.3 Operating personnel

The COMPACT 2 NDT should only be operated by personnel who are trained in accordance with the corresponding national regulations in the use and operation of diagnostic X-Ray systems.



#### NOTE

Only properly trained and authorized personnel are allowed to work with the automated X-ray film processor COMPACT 2 NDT.

---

The user, as well as the service personnel, must pay attention to the warnings, notices and safety instructions located on the device and in the user manual. Failure to comply with the information provided can lead to injury.



#### NOTE

Operating personnel are required to acquaint themselves with all warnings (warning signs) located on the device. They serve to ensure the safety of the operator as well as others and set a basis for orderly operation.

---

### 2.1.4 Ventilation



#### WARNING!

**Inhalation of chemicals can be dangerous to your health and should be avoided. For this reason, always ensure that the room in which the processor is installed is adequately ventilated.**

---

### 2.1.5 Interaction with external devices

Unwanted interaction with external devices is not known.

### 2.1.6 Electromagnetic Environment and the influence of devices

The automated X-ray film processor COMPACT 2 NDT is intended for the usage in a professional environment of material testing.

### 3 Installation



#### WARNING!

Electrical connections should be carried out according to regulations by an electrician.

#### 3.1 Requirements for installation

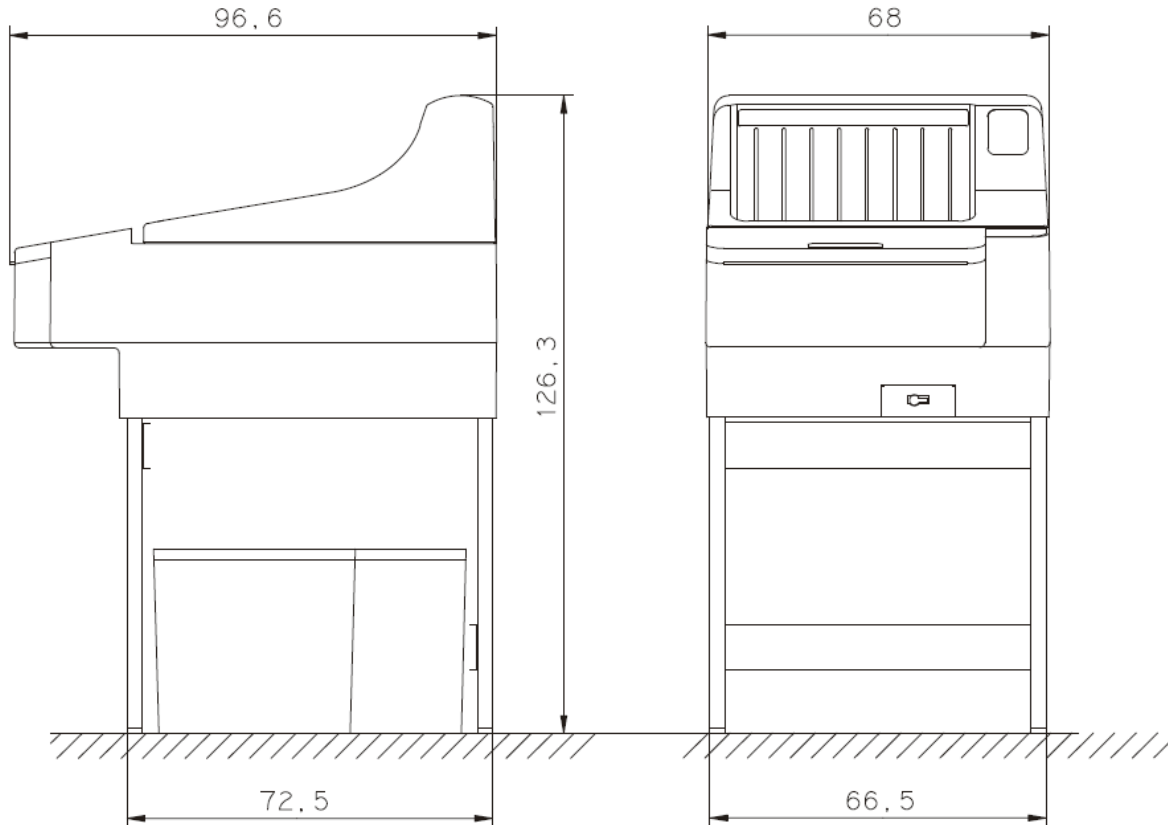

- Fresh water connection: Stop cock with 3/4" outer-thread diameter (washing machine connection), Water pressure 2 - 10 bar (29 - 145 psi).
- Drainage connection: Plastic tube - inner diameter 50 mm (2") or larger. A ventilated syphon which serves as odour preventor should be included in the planning. The drainage tubes should be installed with a fall of minimum 5 %. Local Water Authorities regulations should be complied with.
- Electrical connection: Fused wall socket with earth connection according to electrical data (see technical specifications, see 10). It is also required to install an earth-leakage switch (with 25 A / 30 mA nominal error current).

#### 3.2 Transport

Due to the weight and dimensions of the film processor COMPACT 2 should always be carried by two persons. To do so, hold the machine at the sides on the bottom (see figure). While putting the machine down, watch the position of the levelling feet to prevent damaging these.

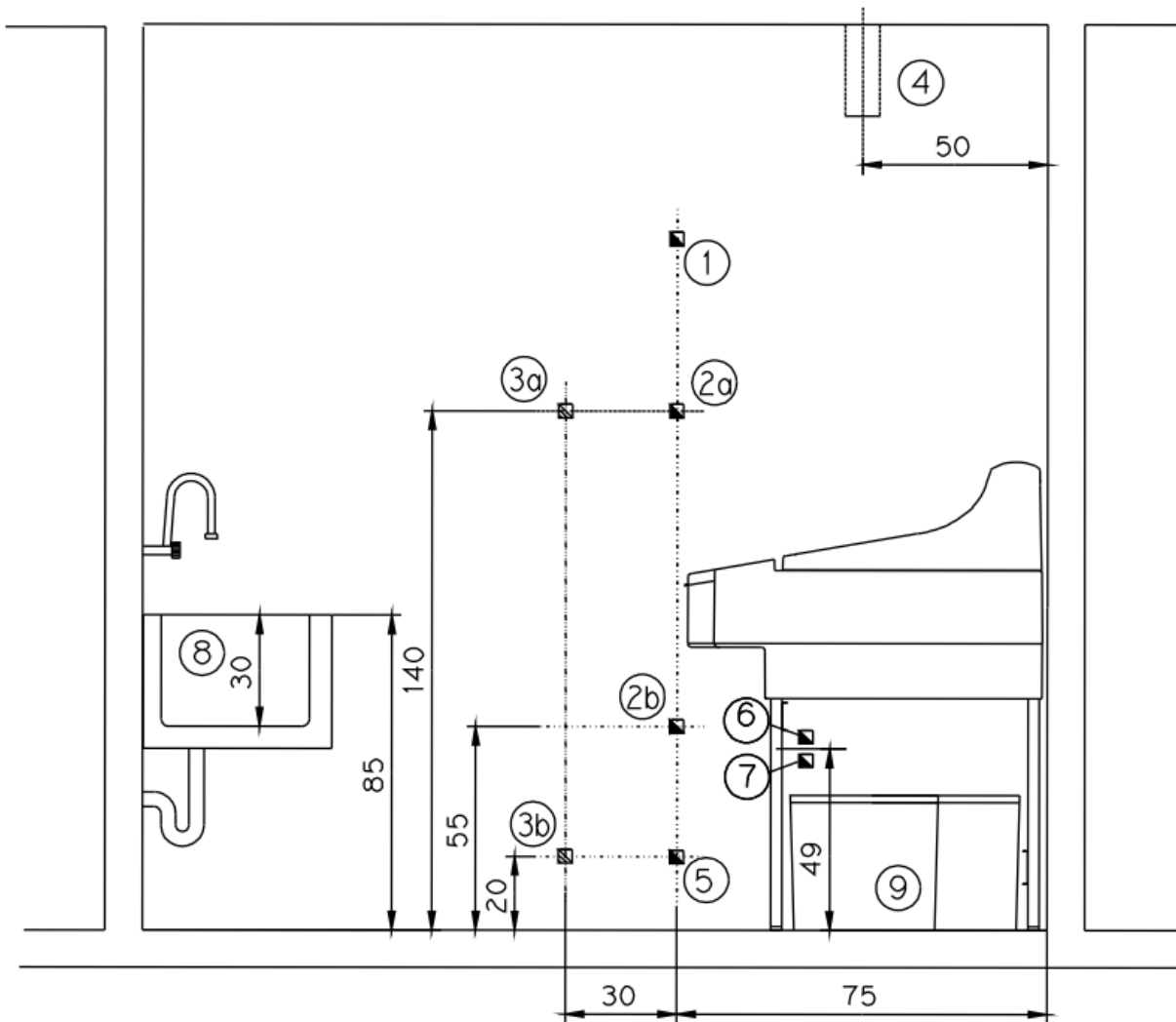

1. Mains 220-240V, 16 A  
Cu wire-cable 2,15mm<sup>2</sup>, Ground-Leakage-Switch 25A / 30mA; Connected load 2.2 kW..
2. 2a Power switch:16 A, 140cm above floor.  
2b Machine connection: Socket incl. Earth 60cm above floor.
3. 3a Water connection: Water consumption 1,9l/min. Water temperature may not be below 5°C.  
3b Waters top cock ¾"connection.
4. Ventilation of darkroom is necessary.
5. Drainage hose PVC, diameter 50mm, acid resistant. Odour lock with hose connection.
6. Drainage for developer, Hose connection 10mm. Suitable collection containers must be provided. Pay attention to local wastewater regulations!
7. Drainage for fixer; Hose connection 10mm. Suitable collection containers must be provided. Pay attention to local wastewater regulations!
8. Sink with hot/cold water and flexible hose; Inner dimensions are 60x40x30cm deep. Material: Ceramic, stainless steel, plastic.
9. The replenishment containers can be place under the processor or can be installed externally.

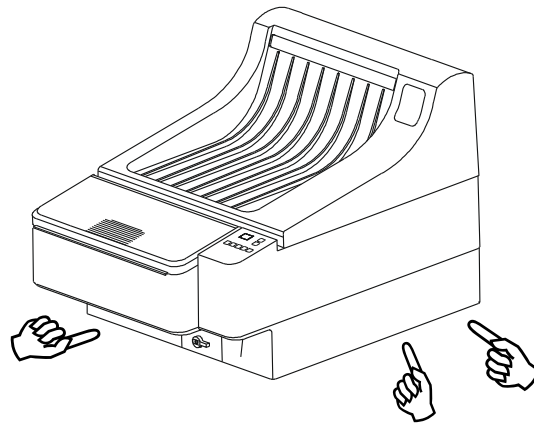

### 3.3 Installation of processor

Unpack and assembly base table/base cabinet respectively according enclosed manual.

Unpack processor and mount onto base table/base cabinet respectively according to manual. Remove the transport securing bars of the roller-racks. Fit the gear and dryer plates to the water/dryer-rack.

- 1 Machine cover
- 2 Light protection cover on film feed
- 3 Control panel
- 4 Power switch an main fuses
- 5 Replenishment tanks
- 6 Drain cock for water tank
- 7 Connection for freshwater, replenishment and drainage respective overflow
- 8 Levelling feet

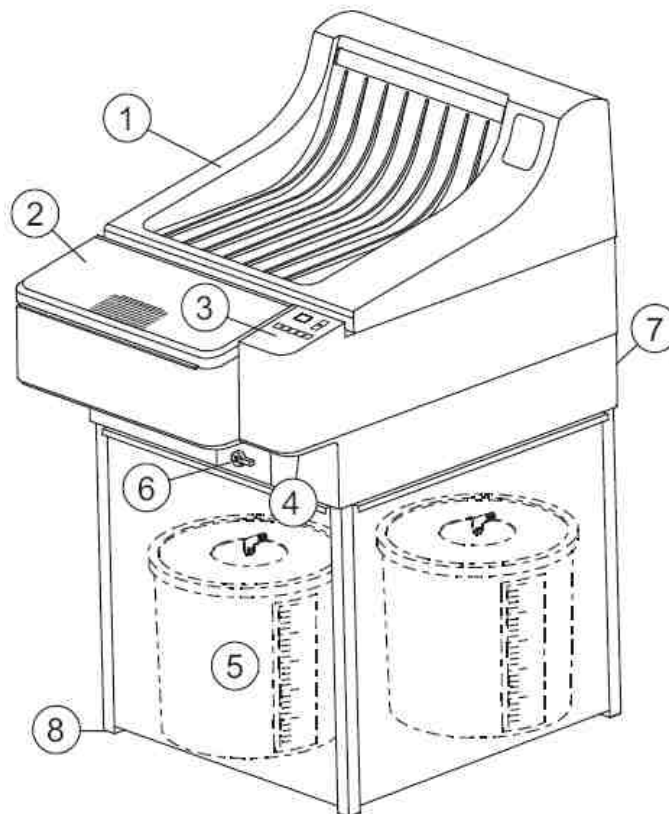

Depending on model type the COMPACT 2 has either an open stand or like shown here a closed cabinet.

### 3.4 Levelling of processor

Levelling of machine: Place machine in working position and level with spirit level. To do this, take off machine cover and place spirit level across the two intermediary rinsing channels. Level machine by adjusting the feet on the table legs. Accurate levelling is essential to avoid possible overflows at a later point in time.

Connect power cord: Lay power cord so that it will not be tripped over and not be bent or frayed. If an extension cord is required use only cords that have been approved for usage with respective current.

### 3.5 Connecting the processor

---



#### NOTE

Inform yourself of the local water board regulations regarding drainage. These regulations may differ from information in this manual, but they should be complied with.

---



#### WARNING!

##### Danger of Overflow!

Use the included cable binders (accessory bag) to secure the hoses. Fix all hose ends which guide into syphon or collecting container, so that they do not drop into the liquid.

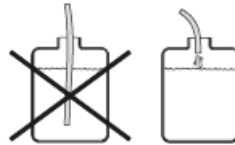

#### WARNING!

The hose piping should be straight (without the hoses going up and down) with a constant fall. The hoses should be as short as possible and without bends and kinks. This is very important for the water overflow hose. Bad piping work will cause the machine to overflow!

---



#### WARNING!

If the machine is installed table-top, ensure that the table is stable enough and does not wobble.

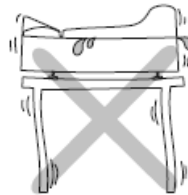

#### 3.5.1 Water connection

Water connection: Fit water-inlet hose (grey) at the rear of the machine and connect to the prepared fresh water supply.

All other hoses (see diagram): Connect the enclosed hoses according to colour system to backside of machine. Put hose clip (enclosed in accessory bag) over hose end, before attaching to connection. Warm up hose end (with hot water or lighter) and push onto the respective connection. Finally push clip over hose and connection.

Cut hoses to required length. Integrate the stop cocks into the drainage hoses in such a position, that they are easy to reach.

Connect the suction pipes to the hose ends for the replenishment tanks using hose clips. Put suction pipes through cover opening into respective replenishment tanks and snap them in.

The overflow and drainage hoses from the developer and fixer should be guided into their respective collecting containers.

The overflow and the drainage of the water can.

### 3.5.2 Hose Connection

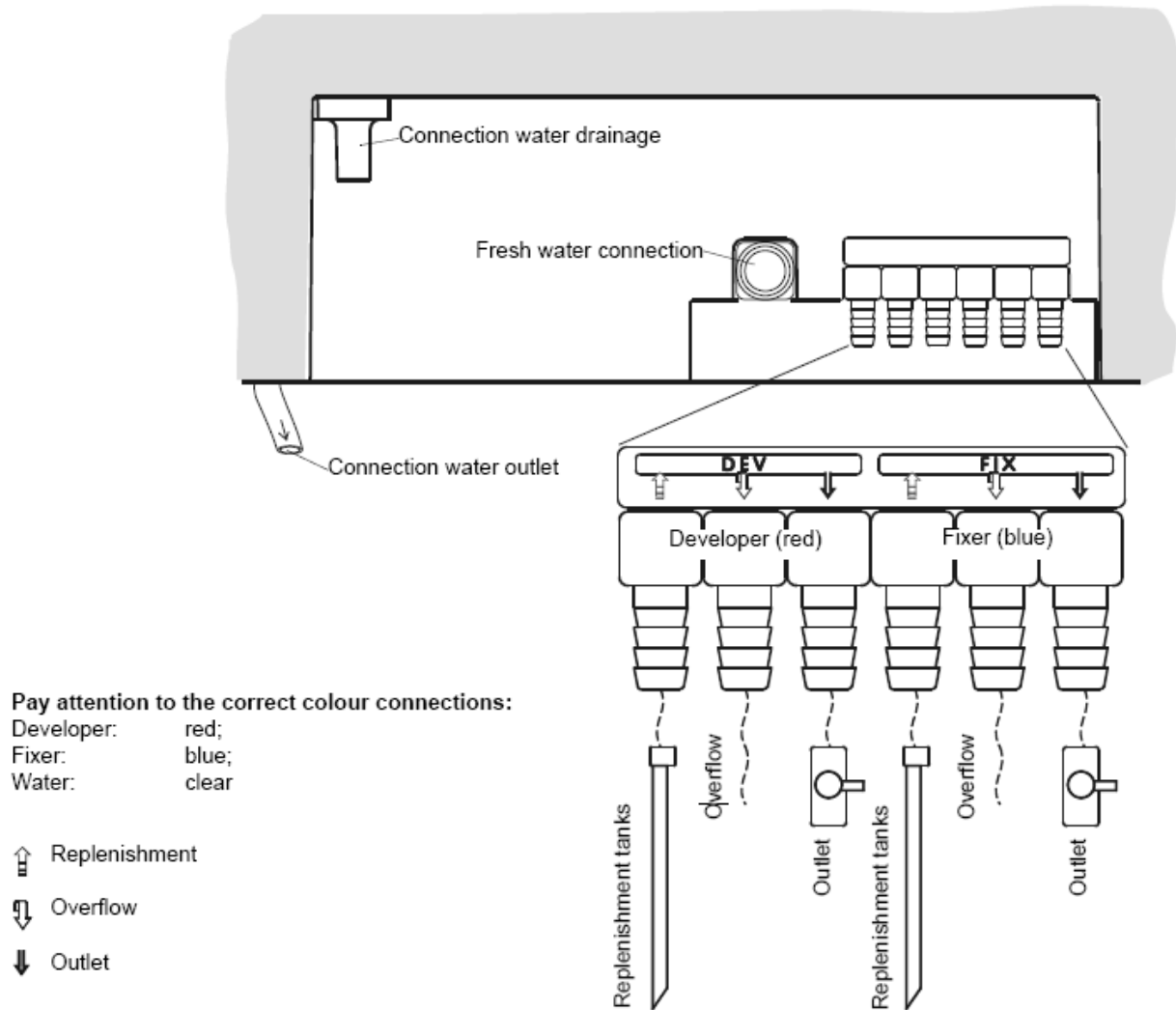

## 3.6 Initial Operation

### 3.6.1 Test run



#### **CAUTION!**

**Processor should not be run dry!  
Upon commissioning and every refilling the pumps must be vented.**

- 1 Close the three drainage stop cocks (front and rear). Fill the developer and fixertank and also the replenishment containers with water. Open water inflow tap. Switch the machine on at the main switch. Water now flows into water tank.
- 2 The circulation pump runs after switching on the machine and ventilates itself. If this does not occur, switch the machine off again. Open the stop cock of the respective chemical for five seconds and close it afterwards again. Switch the machine on again. Repeat this procedure until the pump is ventilated.
- 3 Before filling with chemicals, check all hose connections again for leakage. Switch machine off and drain water out.

### 3.6.2 Fill processor with chemicals

Prepare chemicals inside the replenishment containers according to manufacturer's instructions. By using a suitable container, pour chemicals into the respective tanks.

When filling, be sure that chemicals do no splash from one bath into another. Fixer chemicals destroy developer chemicals! Depending on the chemical type add starter solution. Place the floating cover into developer replenishment container. Close container cover firmly and insert the suction tubes. Pay attention to the colours: *Red= Developer, Blue = Fixer*.

### 3.6.3 Mode of Operation

The processor develops, fixes, rinses and dries

Your films. The temperatures, speed and replenishment rates required for processing various types of film-materials can be individually selected and stored in the microprocessor control unit.

### 3.6.4 Automatic filling and heating

When the machine is switched on, the water tank fills and chemical baths heat up automatically. During this procedure the display shows two serifs "--" and the developer temperature button blinks until the set temperature has been reached. The two serifs show the operator, that the machine is not yet ready for processing. Once the set temperature is reached, the machine is ready for processing. The developer button no longer blinks.

### 3.6.5 Stand-by mode

After a film has been processed, the machine automatically switches to the standby mode during which the bath temperatures are maintained. The bath temperature is maintained. The built-in circulation pumps ensure that the bath liquids are circulated and the temperature is evenly maintained and constant. Every 20 minutes an anti-crystallisation programme starts to rotate the rollers, which avoids the building up of aggressive crystals on the rollers within the machine. During very long standby periods, and after a set time, the control unit activates a replenishment cycle to avoid oxidation of the chemicals in the machine (time replenishment).

### 3.6.6 Film registration

The special impulse-reflex-light barrier for film registration has been constructed in such a manner that even infrared sensitive films are not exposed. When a film is fed in, the light barrier starts the machine.

### 3.6.7 Automatic replenishment

The quality of the developer and fixer chemicals is reduced when films run through the baths and for this reason a regular replenishment of the chemicals is necessary. By means of the light barrier, the film surface of processed films is measured. After approx. 0.25 m<sup>2</sup> of film has passed through, a replenishment cycle is activated. During this cycle, chemicals are pumped up from the replenishment containers into the machine. The replenishment quantity can be adjusted by setting the replenishment rate.

## 4 Control elements and device displays

### 4.1.1 Control elements and device displays standard

- 1 Display working parameters
- 2 Arrow button „Up“ = increase parameter value
- 3 Arrow button „Down“ = decrease parameter value

#### Mode Button

- 4 Processing time in minutes
- 5 Developer temperature in °C
- 6 Dryer temperature in °C
- 7 Developer replenishment time in seconds
- 8 Fixer replenishment time in seconds

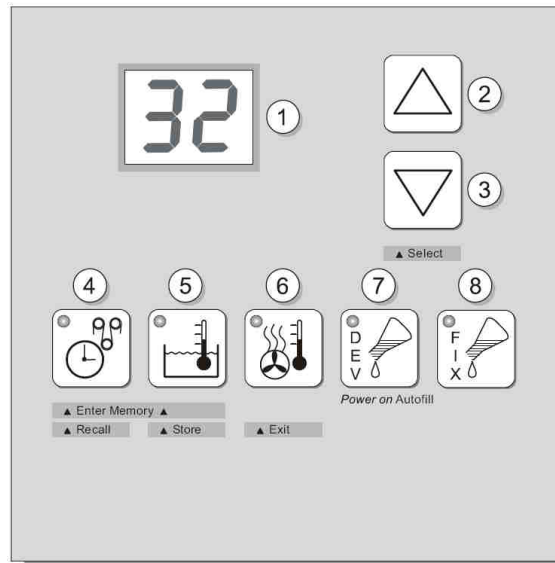

#### NOTE

Safety function stops film transportation when cover is removed.  
Therefore keep cover placed on the machine when processing films.

## 5 Handling / Operation

---



### CAUTION!

Upon first operation and each refilling of a developer check the function of the circulation pump and vent the pump if required.

---



### CAUTION!

Never start the machine up unless it is filled with liquid!

---



### CAUTION!

Do not place any object on the processor.

---



### NOTE

High or low room temperature may influence the function of the film processor machine.

---



### WARNING!

Hot air can escape when opening the light protection cover!  
Surface film feed tray (sheet) can be hot!

---

### 5.1 Operation

#### 5.1.1 Before use

- 1 Close water-drainage stop cock
- 2 Open water tap
- 3 Switch processor on
- 4 Check liquid level in replenishment and drainage collecting containers
- 5 Wait until the developer temperature is reached. If the temperature has not been reached
- 6 Run cleaning films through processor

#### 5.1.2 Working procedure

- 7 Processing films:  
Open light protection cover. Important: Put film first on *left* side of infeed tray and then feed in.  
During processing films please watch the display „Infeeding film“.
- 



### NOTE

Put the film first on left side of infeed tray and then feed in.

---



### CAUTION!

During processing films not the display „Infeeding film“

---

#### 5.1.3 After work

- 8 Switch processor off
- 9 Close water tap
- 10 Open water-drainage stop cock and drain water out of the machine.

### 5.1.4 Stand-by mode

When no film is being processed, the machine switches to Stand-by. The chemicals remain at a constant temperature. The film transport and water inflow activate at intervals to avoid crystallization of the chemicals on the transport rollers. Entry of the next film is possible at any time.

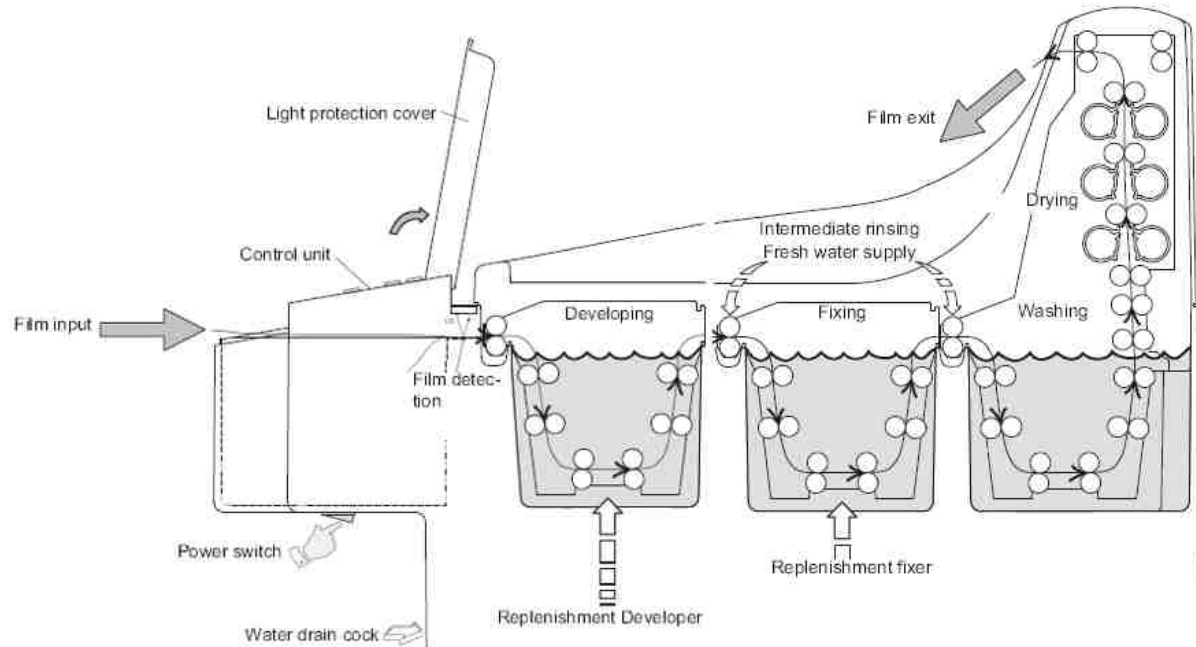

## 5.2 Function of the automated X-ray film processor

### 5.2.1 Switching on the machine

Before switching the machine on, open the fresh water tap and close the water drainage tap (under control panel). Then switch the machine on (main switch is situated under the control panel). Once the machine is switched on, a "Start-cycle" of eight minutes duration is activated: A replenishment cycle is carried out, the water tank fills automatically and the chemical baths heat up. During this "Start-cycle" no films can be fed into the machine. The display shows two bars "--" when the processor is not ready and no films can be fed in. This is the case during the "start cycle" and also when the baths have not reached the temperature. Until the developer temperature is not reached, the developer temperature button (5) is flashing. It is possible that the chemical bath has not reached the required temperature even after the "Start-cycle" has been completed. You need to wait until the developer temperature is reached, before inserting films. Wait until the bars "--" disappear from the display.

### 5.2.2 Automatic mode

After completion of the "Start-cycle" and after a film-processing, the machine automatically goes into the stand-by mode. In the stand-by mode the processor can be started at any time by placing a film into infeed tray. Note that films can only be processed when the developer temperature is reached. When the display shows two bars "--" no films can be fed into the machine. The temperature in the bath is too high or too low. However, when a film was fed into the machine, two bars with decimal points "-.-". To avoid a jamming of films wait before feeding the next film in until this display disappears (which is also signalled by an acoustic sound).

A film in the infeed-tray is registered by the light barrier and the machine starts up. The film is pulled into the machine and transported through the developer, fixer and water baths. The remaining time of processing i.e. until the film finally leaves the machine is displayed, when no more film is in the infeed-tray and the processing time button was pressed. Each working-parameter can be called up on the display by pressing the respective mode-button, however, during processing, parameters cannot be altered. The temperatures of the developer and dryer are automatically regulated. The replenishment rate of developer and fixer chemicals is activated according to the processed film-surface (film-surface

measurement). Before a film is passed on from the developer bath into the fixer bath, it is rinsed with clean water which minimises pollution of the fixer chemicals with developer chemicals. The film is then dried in the dryer before passing out of the machine and falling into the catch tray. The machine then goes into the stand-by mode. To keep the machine in working condition during the stand-by mode, the electronics have been furnished with two specialities: The Anticrystallisation Function and the Time Replenishment.

### 5.2.3 Anti-crystallization function

During the stand-by mode, the film transport, the dryer ventilation and the water inflow are activated every 20 minutes for a period of 15 seconds. This prevents the build-up of crystals on the rollers. This function cannot be switched off.

### 5.2.4 Time replenishment (Anti-oxidation function, Flood replenishment)

Also during the stand-by, the developer chemicals are subject to change which causes their deterioration. By means of the time replenishment, a replenishment cycle is activated after a set time. With this function, the quality of the developer chemicals are maintained even when standing idle for long periods. The setting-range for the time-replenishment is from 5 up to 99 minutes. When "0" is set, the time-replenishment is de-activated.

#### 5.2.4.1 Setting off the time replenishment

- 1 Switch processor off
- 2 Press the buttons processing time (4) and replenishment time (7) simultaneously and keep pressed
- 3 Switch the machine on again and release the pressed buttons
- 4 Select the replenishment interval time (min.) by pressing the arrow buttons (2 and 3). The arrow up button (2) increases and the arrow down button (3) decreases the value
- 5 Switch processor off again.

Example: At the setting "45" a replenishment cycle is activated every 45 minutes.

### 5.2.5 Working parameters

The processing machine develops, fixes, rinses and dries the film materials automatically. The film and chemical requirements can be adjusted accordingly and stored in the control unit.

#### 5.2.5.1 Display working parameters

- 1 Switch processor on
- 2 Press the respective mode button (4-8) and keep pressed to display the required working parameter *or* Press the respective mode button (4-8) and release to display the momentary value.

#### 5.2.5.2 Setting working parameters

- 1 Switch processor on
- 2 Machine must be in the stand-by mode and no film must be in the processor
- 3 Press the respective mode button (4-8) and keep pressed: The display shows the set working parameter
- 4 Change the value by means of the arrow button (2 and 3) until required value appears on the display. The upward arrow button (2) increases and the down arrow button (3) decreases the value
- 5 Release the mode button

### 5.2.6 Processing time

The processing time, is the time, it takes the front end of a film from the infeed of the processor until it reaches the film exit. The processing time is set by the speed with which the film is transported through the machine. Depending on the requirements, this time can be varied from 2 to 10 minutes adjusted in 0.1-minute-steps (adjusting the processing time: see 5.2.5.2)

<b>Processing and developer time relation</b>		
<b>Processing time (min)</b>	<b>Developer time (s)</b>	<b>Infeed speed (cm/min)</b>
2.0	28	76
2.5	35	61
3.0	42	51
3.5	49	45
4.0	57	38
4.5	64	34
5.0	71	31
5.5	77.5	28
6.0	84	25.5
6.5	91	24
7.0	98	22.5
7.5	106	21
8.0	114	19
8.5	121	18
9.0	128	17
9.5	135	16
10.0	142	15.5

### 5.2.7 Developer temperature

The developer temperature of the different film-materials depends on the developing time. The faster a film has to be developed, the higher the temperature must be. The developer temperature can be set between 28-40 °C according to the individual requirements (Setting the developer temperature: see "Setting the working parameters:"5.2.5.2). If the temperature is lower or higher than the set value, then the bath temperature button (5) is flashing and the display shows two bars "--". Before feeding a film into the machine, wait until the temperature has been reached and the displayed bars "--" disappear.

The following chart demonstrates guide value relations between developer temperatures and processing times. Variations are possible depending on the various films and chemicals.

<b>Processing time and developer temperature relation</b>	
<b>Total processing time (min(s))</b>	<b>Developer temperature (°C)</b>
2,5 (150)	31 - 33
3,0 (180)	31 - 33
4,5 (210)	31 - 33
4,0 (240)	30 - 32
5,0 (300)	30 - 32
5,5 (330)	30 - 32
6,0 (360)	29 - 31
6,5 (390)	29 - 31
7,0 (420)	29 - 31
7,5 (450)	28 - 30
8,0 (480)	28 - 30
8,5 (510)	28 - 30
9,0 (540)	27 - 29
9,5 (570)	27 - 29
10,0 (600)	26 - 28

### 5.2.8 Dryer temperature

The dryer temperature can be adjusted within a range of 35-70 °C according to the different film-materials. To avoid dryer spots on the film, the dryer temperature may not be set too high. Adjust the temperature so that the film just gets dry (Setting the dryer temperature: see "Working Parameters" 5.2.5.2).

**Remark:** Depending on mains voltage dryer temperatures above 65°C may under certain circumstances not be reached.



#### CAUTION!

**High or low room temperature can influence the function of the film processor.**

### 5.2.9 Replenishment time

The replenishment of the developer and fixer chemicals is automatic. By means of the light barrier electronic at the film-infeed, the surface of the processed films are calculated and after 0.25 m<sup>2</sup> a replenishment cycle is automatically activated. The replenishment quantity can be adjusted varying for developer and fixer by adjusting the replenishment time. The replenishment time may be set in a range of 3-60 s.

The chart below shows the replenishment time to be set for the requested replenisher rate per m<sup>2</sup>-film surface. The standard setting is 10 sec. with 500 ml replenisher rate per m<sup>2</sup> film surface. The replenisher rate has to be adjusted depending on film material, chemicals and film throughput.

Relation of replenishment time and replenisher volume		
Replenisher volume (ml/m <sup>2</sup> )	Replenishment time(s)	Replenishment rate (ml per cycle)
212	4 (4)	53
320	6 (5)	80
428	8 (7)	107
532	10 (9)	133
692	13 (11)	173
800	15 (12)	200
908	17 (14)	227
1012	19 (16)	253
1120	21 (18)	280
1224	23 (20)	306
1332	25 (22)	333
1440	27 (24)	360
1546	29 (26)	386,5
1652	31 (28)	413
1760	33 (30)	440
1866	35 (32)	466,5
1972	37 (34)	493



#### NOTE

Values in brackets for 60Hz power connection.

Values when pump is seat at 100% pump capacity.

## 5.2.10 Dimmer Function of Display

With the dimmer function the intensity of the control panel display can be changed. The intensity can be reduced to avoid possible exposure of high-sensitive films. Normal-sensitive films are not affected by the display.

### 5.2.10.1 Setting the intensity of the display

- 1 Switch processor on
- 2 Press arrow „down“ button (3) for about 5 seconds. The intensity changes. Two intensity-levels are available, bright and dark. During film-throughput this functions is not available

## 5.2.11 Machine cover Safety Disconnection

The machine cover may only be removed for service and maintenance purposes. The processor cannot be started without the cover. In the event that the machine cover is removed during film-throughput, the film transport will be stopped. On the display the error message "E1" will be displayed. The error will be reset when the machine cover has been replaced.

## 5.2.12 Auto fill Function



In case new chemicals have to be filled into the processor (after installation, tank cleaning), the tanks can be filled automatically by means of the autofill function. In the process, the tank is filled for a fixed period of 17 minutes, that is, chemicals are pumped from the replenishment containers to the tanks. Also the water bath will be filled (8 min. period). The display will show two symbolized tanks. When the autofill function has been completed, the machine enters the stand-by mode. In the event of the respective baths being full before the time is up, the autofill function can be manually stopped.

### 5.2.12.1 Starting up the auto fill function

- 1 The chemicals containers need to be filled manually with at least 1.0 litres of fresh chemicals, to ensure the pumps will not run dry!
- 2 Switch processor off
- 3 Filling developer *and* fixer tank: Keep both replenishment buttons for developer (7) and fixer (8) pressed down and switch the machine on. *or filling* developer *or* fixer tank: Keep respective replenishment button (7 or 8) pressed down and switch the machine on.

### 5.2.12.2 Manual cancellation of the auto fill function

- 1 Stop developer tank filling: Keep developer replenishment button (7) pressed down and press "arrow down" button (3).
- 2 Stop fixer tank filling: Keep fixer replenishment button (8) pressed down and press "arrow down" button (3).

The filling of the water bath will be stopped once the automatic filling of both chemicals baths has been stopped.

## 5.2.13 Manual Mode

In the manual mode, the processor works without the light barrier. The film transport has to be started and stopped manually. All the set values in the manual mode are also valid in the automatic mode. Please note that the Infeeding-film-display ("– –") is deactivated. In the Manual Mode the replenishment function does not use film surface measurement, instead it uses a standard value. In the manual mode, a replenishment cycle can also be activated manually.

### 5.2.13.1 Switching to manual mode:

Switch the machine on. During stand-by, press the arrow-buttons "up" (2) and "down" (3) simultaneously. When in manual mode the display is flashing.

### 5.2.13.2 Switching back to automatic mode:

In manual mode with film transport off press both arrow-buttons "up" (2) and "down" (3) simultaneously.

### 5.2.13.3 Manual starting and stopping the film transport

- 1 Switch to manual mode
- 2 Press the processing time button (4) – the button illuminates
- 3 Start the film transport by pressing the arrow-button "up" (2) or stop the film transport by pressing the arrow-button „down“ (3)

### 5.2.13.4 Manual replenishment

- 1 Switch to manual mode
- 2 Press required replenishment button for developer (7) or fixer (8) – respective button illuminates
- 3 Start the replenishment cycle by pressing the arrow-button „up“ (2) or cancel the replenishment cycle by pressing the arrow-button „down“ (3)

## 5.2.14 Use of Memory Function

In the memory five sets of parameters can be stored and be recalled into working memory.

### 5.2.14.1 Store processing parameters

- 1 Set machine to preferable parameters e.g. bath temperature, processing time etc. (see manual).
- 2 Press buttons 4 and 5 "Enter Memory" simultaneously to enter the memory mode.
- 3 Use buttons 2 and 3 "Select" to select the parameter memory (P1 to P5). Inside this the parameters will be stored, old values will be overwritten.
- 4 Press button 5 "Store" to store parameters and to leave the memory mode.

### 5.2.14.2 Recall processing parameters

- 1 Press buttons 4 and 5 "Enter Memory" simultaneously to enter memory mode.
- 2 Use buttons 2 and 3 "Select" to select the parameter memory (P1 to P5) from which the parameters shall be recalled.
- 3 Press button 4 "Recall" to recall parameters (copy into working memory) and to leave the memory mode.

### 5.2.14.3 To leave memory mode without change

Press button 6 "Exit".



#### CAUTION!

**Please note, if input is locked (via lock function), then processing parameters cannot be stored - when trying to do this, an error message "LO" will be displayed. Despite locked input, the processing parameters can be recalled.**



#### CAUTION!

**Choose the same bath temperature for all stored programmes. Of course different bath temperatures can be stored too, but when changing the programme you always have to wait until the changed bath temperature is reached.**

## 5.2.15 Lock Function

To prevent unintentional change of operation parameters the input can be locked. If the input is locked any attempt to change the parameters will display an error "LO" (locked).

### 5.2.15.1 Activating and de-activating of the input lock

- 1 Press buttons 4 and 5 "Enter Memory" simultaneously to enter the memory mode (see diagram see 5.2.15).
- 2 Press several times the button 3 "Select" until the display will show "L.0"(Lock off input unlocked) or "L.1" (Lock on: input locked).

- 3 Now by pressing one of the buttons 4 or 5 change the display: "L.0" if you want to unlock the input or "L.1" if you want to lock the input.
- 4 To finalize the changes press button 6 "Exit".

**NOTE**

Even when the input lock is activated it is possible to recall (previously stored) processing parameters of the memory-function.

---

**CAUTION!**

**Please note, if input is locked via lock function, then processing parameters cannot be stored - when trying to do this, an error message "LO" will be displayed.**

---

**5.2.16 Stop Film Transport**

In a case of a film-jam inside the machine, the film transportation can be manually interrupted. To stop the film transport press both arrow-buttons (2 and 3) simultaneously.

Related topics:

See "Manual starting and stopping the film transport:" 5.2.13.3

See "Film is caught up in the racks": see 5.4.2.10

**5.2.17 Infrared Sensitive Materials**

Infra-red sensitive film material can be processed without danger of exposure by the light-barrier.

**5.2.18 Automatic Cooling Function**

If the developer temperature exceeds the set value, the automatic cooling function will be activated. The fan runs for a fast cooling of the bath. The same happens when the temperature is decreased by pressing the arrow button.

### 5.3 Removal and Installation of Dryer Rack (two-parts)

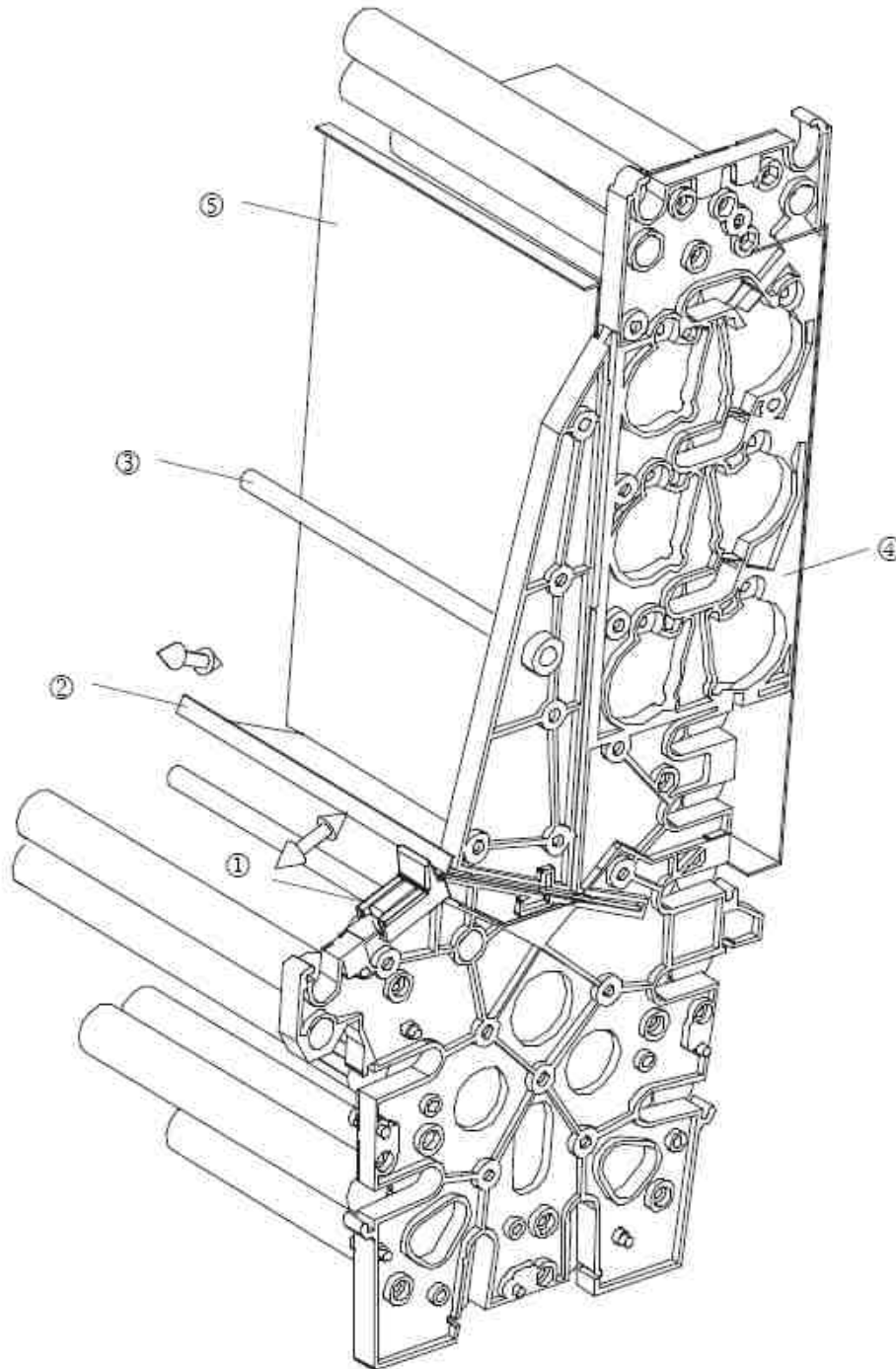

#### 5.3.1 Removal

- 1 Push small, black slide (1) downwards.
- 2 Pull dryer plate small (2) out of the dryer.
- 3 The upper part of the dryer can now be removed. Hold the dryer at the front distance bar (3) and the whole of the metal plate in the back (4).
- 4 Take out lower part of the dryer.

### 5.3.2 Installation

- 1 Insert lower dryer part. Make sure that both slides at the lower part are assembled and pushed down.
- 2 Put in the upper dryer part. Insert the lower edge of the upper part carefully into the middle guidance of the lower part.
- 3 Check if side plates and gears of upper and lower part fit together correctly.
- 4 The dryer plate small (2) can now be assembled into the guidance. For this lift dryer plate large (5) a bit, so that the small plate can be pushed in, completely.
- 5 Now push both black slides (1) up until the clips click into place.

## 5.4 Problems and Solutions

### 5.4.1 Advice on Film Defects

Your processor has been constructed for long term use. If however irregularities might occur, you will find help to locate the problem below. Please check the listed points, before calling your service-technician.

#### 5.4.1.1 Films do not have enough density

- Bath temperature is too low
- Developing time too short
- Exposure time is too short
- Replenishment rate of developer too low
- Developer chemicals are exhausted or too strong diluted: Renew
- Fixer solution has been mixed into developer: Renew. Clean and rinse bath well before refilling
- Circulation is broken down

#### 5.4.1.2 Too high a density

- Bath temperature too high
- Developing time too long
- Exposure time is too long
- Replenishment rate of developer too high
- Developer chemicals are too high diluted: Renew
- After renewing chemicals: Starter is missing
- Circulation is broken down

#### 5.4.1.3 Films will not dry

- If warm air comes out of the air channel in the dryer, chemicals and film type should be checked
- Fixer solution is exhausted or diluted

#### 5.4.1.4 Film has a yellow-green surface

- Not fixed correctly. Check the film type and fixer chemistry
- Fixer solution is exhausted or diluted. Replenishment rate of fixer is too low

#### 5.4.1.5 Scratches, pressure marks, dirt on film

- Prior to processing films, run cleaner films through the processor
- Pressure marks caused by careless handling, finger nails etc.
- Rollers are polluted. Clean tanks and roller racks

#### 5.4.1.6 Cloudy film

- Level in developer is too low
- First guide bar of fixer rack is dirty (condensate or crystals). Clean roller racks
- Developer is old or circulation not working
- Try processing films by infeeding them with emulsion side up

## 5.4.2 Advice on Machine Errors

### 5.4.2.1 Machine does not switch on

- Ensure that electrical plug is firmly inserted into socket. Ensure that electrical socket has power supply by testing with an appliance (e.g. table light)

### 5.4.2.2 Rinsing water does not flow

- Open water inflow tap
- Water pressure in the water system is too low: Minimum pressure 2 bar (29 psi)

### 5.4.2.3 Replenishment rate too high

- Check the programmed times of replenishment cycle and replenishment time

### 5.4.2.4 Replenishment rate too low

- Check the programmed times of replenishment cycle and replenishment time
- Check whether the machine can be started by each of the light barriers (4 pieces). In the case of a light sensor being faulty, call your service technician. In the meantime, double the programmed replenishment time

### 5.4.2.5 Replenishment pump does not pump

- Check whether the replenishment containers are full and that the end of the suction pipe is positioned under the liquid level
- Check whether there is air in the replenishment pipes. If this is the case, then check the pipe connection

### 5.4.2.6 Water tank overflows

- Water drainage hose (overflow) is bent. The hose end should be positioned above the drainage level in the syphon
- Check water drainage in the tank and hose for blockage and pollution. The drainage hoses should have a constant inclination

### 5.4.2.7 The film does not transport correctly

- Film is fed in and gets caught in the machine: Check the positioning of the racks in the machine and make sure that the latches are closed.

### 5.4.2.8 Film cannot be fed, the display shows „E1“

- Close machine cover securely, paying special attention that the switch on the rear of the control panel is actuated

### 5.4.2.9 Film is in the infeed and nothing happens

- Display is flashing: Control is in the manual mode. Switch back to Automatic mode (see 5.2.2)
- Developer-temperature button is flashing: The temperature of the developer has not yet been reached. Wait until temperature has been reached and the button stops flashing
- Push the film deep into the infeed and move this from side to side. If the processor still does not start then call your service technician. In the meantime, with limitations the processor can be worked with in the Manual Mode

### 5.4.2.10 Film is caught up in the racks

- Switch machine off and remove cover
- Check in which rack the film is caught up in and remove the respective rack
- If possible, catch hold of the film end by hand and by manually turning the drive-shaft, pull the film out of the rack
- Replace the rack and secure with fastener. Replace machine cover and switch the machine on again.

- If a film is caught up in the machine due to a power cut, it can be transported out of the machine by activating the transport with a film in the infeed (machine can also be started up in the manual mode, see 5.2.13.3, „Manual starting and stopping the film transport“).



### CAUTION!

**Ensure correct seating of roller racks; keep the lock closed at all times.  
Don't operate processor with empty replenishment tanks.  
After a long machine shut down check bath level and refill if necessary.**

## 5.5 Error messages

Machine errors are shown on the display as abbreviations. The cause of error is explained below. For service technician: problem solution see "Trouble shooting" capture 7.

Display	Cause and possible correction
E1	Cover switch is not actuated. Place cover correctly on the machine and ensure that the cover switch behind the control panel is actuated. If the error cannot be corrected, then the cover switch may be defective.
E2	Motor servo-control defective, call service technician. In the meantime work can be continued with the last set processing speed. The processing speed cannot be altered. (Service see "Error messages" see 7.3.3).
E3	Drive-overload, take off machine cover and remove all roller racks. Check each rack for easy rotation of the drive shaft. If necessary clean roller-racks and machine. Error can be reset by switching the machine off. If the need arises let a service technician check the machine. If the above measures do not improve the situation, the motor may be defective.
E4	Error: Over temperature in dryer section. Call your service technician. Dryer components could be broken. Machine can only be used in manual mode, and the dryer fan runs continuously (error will always be displayed). The machine may only be operated under constant supervision. Check if air is coming out from the opening in the cover. If no air comes out, the fan is defective and the machine may not be used. Switch the machine off. Error can only be reset by switching the processor off (Service see "Display shows error message "E4"" see 7.7.1).
LO	Input locked. To change operation parameters the lock function must be deactivated (see "Lock Function" see 5.2.15)

## 6 Safety and Maintenance

---



### WARNING!

#### Caution Electrocutation hazard!

**Prior to cleaning or disinfection, switch of the automated X-ray film processor. As a result, the processor will be disconnected from power and the danger of electric shock is eliminated.**

---

### 6.1 Introduction

In this chapter, you will find details regarding safety and maintenance, which is required to ensure the correct and reliable function of the radiographic system following initial installation.

### 6.2 Cleaning and disinfection

---



### NOTE

The colour changes in the baths is normal; it is caused by the properties of the chemicals!

---



### CAUTION!

**Do not use alcohol containing solvents to clean the machine!**

---

Pay attention that, during cleaning and/ or disinfection, no fluids find their way into the main housing of the radiographic table. This reduces the risk of short circuits and corrosion.

---



### CAUTION!

**Do not let any liquid drop inside the processor or run over the control. Liquids may cause damage to the processor.**

---

#### 6.2.1 Cleaning

The cleaning of the automated X-ray film processor is very easy due to the very good surface coating. This is usually done only with a dry cloth.

Do not use corrosive, solvent or abrasive cleaning agents that can damage the surfaces of the device or the paint.

Clean the outer surfaces of the unit and all painted components using a damp towel and a mild – light alkaline cleaning agent (e.g. RBS\* Neutral T). Dry the components off following cleaning.

#### 6.2.2 Daily care

Before use

- Remove dirt and dust from film-infeed with soft cloth
- Run 2 - 3 cleaner films through processor to remove all accumulated dirt and dust from the rollers
- Check the liquid level in the replenishment containers and if necessary refill

After use

- When working has been completed at the end of the day, the water must be drained from the machine. This reduces the growth of algae in the water bath. For that purpose open the water drainage stop cock (see 3.5.2)

### 6.2.3 Weekly Care

---



#### CAUTION!

**When removing the Rinsing / Drying roller-rack, ensure that no water gets into the film dryer air channel.**

---

The developer chemicals cause residue build up in the machine. This residue has a negative effect on the developing process of the film material. For this reason the processor has to be regularly cleaned of this residues.

Do a weekly clean of the roller racks, which only takes a few minutes.

- 1 Switch machine off and remove cover.
- 2 Loosen the securing latches (red and beige) of the drive shafts of each roller rack at the right side.
- 3 Rinse all racks thoroughly under warm running water and then leave to drain off. Use a soft sponge (do not use scouring-pad, as this would scratch the rollers!) and remove the pollution from the rollers. During this procedure, the rollers can be turned by turning the drive shaft.
- 4 Wipe the feed-roller-pair (first roller-pair of developer rack) dry
- 5 Replace the racks: Red = Developer, Blue = Fixer. Beige = Washing/Drying. Ensure that the racks are firmly installed and do not forget to close the securing latches on the drive shafts.
- 6 Replace machine cover and ensure it is securely closed.
- 7 Clean processor outer shell with damp cloth. Do not use aggressive cleaners or solvents.

### 6.2.4 Thorough Cleaning

Every 3 – 6 months a thorough cleaning is necessary, depending on the quantity of films processed. Tank cleaners are available for developer and water baths. The fixer bath is cleaned with water. When preparing chemical tank cleaners, follow manufacturer instructions explicitly.

How to proceed:

- Switch the machine off and empty all tanks by opening the stop cocks. Attention: Machine will not drain off, if it is switched on
- Remove machine cover. When all tanks are emptied, close stop cocks again. Now fill the fixer-tank with water. Prepare cleaner solutions for developer and water baths and fill into respective tanks
- Remove suction pipes from the replenishment containers and place them in a water filled bucket. Attention: Do not add chemical cleaners here!
- Close machine cover and switch machine on
- Start film transportation and keep running for 10 to 20 minutes. During this the installed roller racks will be cleaned see 5.2.13.2.



#### NOTE

After completion of tank cleaning, the tank should be rinsed thoroughly with clean water. To do this, fill the machine with fresh water twice and each time, let the machine run for a 10 minute period. Empty the tanks and reclose the stop cocks.

---

- Take out the roller-racks and rinse them thoroughly with running water. Remove remaining dirt from the rollers by using a sponge and clean thoroughly. Doing this, the rollers can be turned by turning the drive shaft. Wipe the feed-roller-pair (first roller pair of developer rack) dry. Replace the racks.
- Refill the tanks with respective chemicals. This can be done by hand or automatically (see 5.2.12). Replace the suction pipes into the replenisher containers. The circulation system may have to be ventilated (see 3.6.1 / 2)
- For quality check, process test films.

### 6.2.5 Before you go on holiday or longer than 2 weeks not use

If the automated X-ray film processor will not be in use for longer than two weeks, all the chemicals have to be emptied out of the tanks. In case you don't want to do a complete tank cleaning at once, then fill the tanks after emptying, with water.

## 6.3 Check-up and maintenance

---



### WARNING!

**It's forbidden to make any check-up or maintenance services while the automated X-ray film processor is in use with a patient! Any check-up or maintenance services can only be done by people who got trained or authorized by PROTEC.**

---



### CAUTION!

**Never start the machine up unless it is filled with liquid!**

---

### 6.3.1 Recommended Maintenance Work

- 1 Functional check  
Film intake / film transport / replenishment / bath heating / dryer heating / water supply
  - 2 Cleaning
    - 2.1 Switch off machine, remove cover
    - 2.2 Empty all three tanks
    - 2.3 Close drain cocks and fill tanks with water
    - 2.4 Install cover, switch machine on
    - 2.5 Fill two additional vessels with water, put suction pipes into these vessels and activate replenishment for at least two minutes (to remove residues of chemicals from replenishing hoses)
    - 2.6 Switch machine on for a few minutes
    - 2.7 Switch machine off
    - 2.8 Empty all tanks
    - 2.9 Prepare tank cleaning agent for developer and water tank according to manufacturer instructions
- 



### CAUTION!

**Do not use chlorine containing cleaning agents.**

---

- 2.10 Fill developer and water tank with tank cleaning agent (**do not use the replenishment pump to do so**)
  - 2.11 Fill fixer tank with water
  - 2.12 Place suction pipes into empty tanks
  - 2.13 Install cover, switch machine on
  - 2.14 Wait until the operating temperature is reached, approx. 30 °C (observe information concerning temperature, time, cleaning procedure contained in the datasheet of the tank cleaning agent)
  - 2.15 Activate manual program and transport
  - 2.16 After approx. 15 minutes (observe information concerning temperature, time, cleaning procedure contained in the datasheet of the tank cleaning agent) switch film transport off
  - 2.17 Remove cover, neutralise developer tank (observe information concerning temperature, time, cleaning procedure contained in the datasheet of the tank cleaning agent)
  - 2.18 Switch machine off
  - 2.19 Empty all three tanks
  - 2.20 Fill machine with water and switch it on
  - 2.21 Put suction pipes into vessels with water
-

- 2.22 Activate regeneration pumps for at least three minutes
  - 2.23 Check all pumps for tightness
  - 2.24 Switch machine off
  - 2.25 Drain tanks
  - 2.26 Fill tanks 3/4 with water
  - 2.27 Switch machine on
  - 2.28 Activate replenishment pumps manually until tanks overflow
  - 2.29 Activate film transport for a few minutes
  - 2.30 Switch machine off and drain all three tanks
  - 2.31 Repeat item 2.20 to 2.30 if required (observe information e. g. concerning temperature, time and cleaning procedure outlined in tank cleaner datasheet)
  - 2.32 Remove roller racks from the machine and remove dirt under flowing water using a soft rag or sponge
  - 2.33 Remove residual dirt particles in tanks and rinsing gutters
  - 2.34 Clean all toothed gear wheels, axles, bearings and rollers, check them for damage (replace if required)
  - 2.35 Remove light protection flap and wipe its underside using a soft rag
  - 2.36 Clean inlet plate using a soft rag
  - 2.37 Reinstall light barrier
  - 2.38 Align roller racks and re-insert them in machine
  - 2.39 Fill machine with chemicals
  - 2.40 Switch machine on
  - 2.41 Adjust bath temperature to previously adjusted value
  - 2.42 Feed cleaning film (approx. 4 pieces)
  - 2.43 Check function as described under item 1.
  - 2.44 Approx. 15 minutes after reaching of the bath temperature, check it by measuring and recalibrate if required (see **Fehler! Verweisquelle konnte nicht gefunden werden.**)
- 3 Perform constancy tests based on the applicable national standards (e.g. IEC61223-2-1 and DIN 6868-2).

### 6.3.2 Maintenance

Required maintenance must be performed at 3-6 month intervals, depending on the film throughput, by PROTEC Service or specific authorized service provider to ensure the safe and reliable operation of the equipment.

In the event that scheduled maintenance is not performed, PROTEC X-ray Systems GmbH will not be responsible for damages incurred by the user or third parties if such damages are the result of improper or omitted maintenance.

Prior to operation, the operator must ensure that all Safety related mechanisms, indicators and/or switches described within the user manual are fully functional and that the unit is overall operationally ready.

See Technical Description of the system and of all integral components.

Only original spare parts are to be used in situations requiring component replacement.

**6.3.3 Maintenance Protocol**

**Installation**

Name:	Machine type:	Serial number:
Technician:	Training:	by:
Telephone:	Date:	Guarantee until:

**Parameters Set**

Developer temp:	Dryer temp:	Cycle time:
Dev.reg. volume:	Dev.reg. volume:	Anti oxidation:
Changed by:	Date:	Film type:

Developer temp:	Dryer temp:	Cycle time:
Dev.reg. volume:	Dev.reg. volume:	Anti oxidation:
Changed by:	Date:	Film type:

Developer temp:	Dryer temp:	Cycle time:
Dev.reg. volume:	Dev.reg. volume:	Anti oxidation:
Changed by:	Date:	Film type:

**Maintenance work performed**

Maintenance work performed	Maintenance work performed	Maintenance work performed	Maintenance work performed
Date	Date	Date	Date
Name	Name	Name	Name
Next maintenance:	Next maintenance:	Next maintenance:	Next maintenance:
Maintenance work performed	Maintenance work performed	Maintenance work performed	Maintenance work performed
Date	Date	Date	Date
Name	Name	Name	Name
Next maintenance:	Next maintenance:	Next maintenance:	Next maintenance:
Maintenance work performed	Maintenance work performed	Maintenance work performed	Maintenance work performed
Date	Date	Date	Date
Name	Name	Name	Name
Next maintenance:	Next maintenance:	Next maintenance:	Next maintenance:

## 6.4 Warranty

---



### NOTE

The current conditions of guarantee are deposited in the order papers or in the valid pricelist to the time of purchase.

---

All repairs and replacement of components because of misuse and/or incorrect operation are excluded from the warranty.

Only authorized technicians may do service and maintenance work.

## 6.5 Product life time

The automated X-ray film processor has an expected product life of 7 years when used in accordance with the product specifications/ limitations and provided that maintenance through the PROTEC service department or a **PROTEC** authorized service provider has be completed. After reaching the life span the further usage of the device happens on own risk.

## 6.6 Further Information

Further information's to the chapters and for a safe usage, transport or storage are in this user manual.

## 6.7 Disposal



Used machine contain value able materials that should be recycled and turned over for proper treatment. Please be sure to turn used machines over to approved recycling centers.

## 7 Trouble Shooting

### 7.1 Algae

#### 7.1.1 Excessive algae growth in water tank

Algae growth inside the water tank is not only annoying, it causes increased cleaning work and leaves residue on the films. When algae growth increases, countermeasures are in demand:

- When work has been completed at the end of the day, drain water out of the machine
- Clean dryer-water rack regularly. Use soft sponge and soap to remove residue from the rollers
- Install a particle filter system in the fresh water supply for the processor
- If no other solutions can be found, then usage of Anti-Algae-Agents can be a great improvement (automatic dispensers work the best). However, it is known that cleaning agents containing chlorine may corrode rubber rollers and high-grade steel in the tank area (check before use)

### 7.2 General

#### 7.2.1 Mains switch "ON" – no function

- Ensure that electrical socket has power supply
- Check machine fuse in main switch
- While power switch is on, check the following components: Voltage on contact of main switch - If there is no voltage, replace the respective component.



#### **CAUTION!**

**For replacement exclusively use PROTEC gold cap fuses. These fuses are optimized for use under existing conditions.**

#### 7.2.2 No display but circulation pumps run

- Check input voltage of 5 V at the contacts no. 7 and 8 of the 8-pole-plug X23 from the control panel PCB. If voltage is present, then exchange the control panel
- Check fuse (5A) on the power PCB
- Disconnect the temperature sensor of the developer bath (X25) and check again
- Disconnect temperature sensor dryer (X24) and check display again

### 7.3 Drive

#### 7.3.1 Machine does not start automatically

When machine is switched on place a film in the infeed until it reaches the pull-in-rollers. If necessary, move the film sideward to activate the light barrier. If the display shows two bars with decimal points, then the light barrier is in order. Check each of the four eyes on the light barrier. Each eye must start the machine - if not then exchange light barrier. Check the connection of the light barrier. If there is no reaction on the display then exchange the light barrier, eventually the control unit has be changed. The display shows "E1": The cover switch is not actuated by the latch on the cover. Cover switch has no current passage when activated: Replace.

Developer-temperature button is flashing: see "Developer bath temperature is not reached" see **Fehler! Verweisquelle konnte nicht gefunden werden.**

#### 7.3.2 Machine doesn't stop automatically

- Display is flashing: Control is in the manual mode. Switch back to Automatic Mode (see 5.2.2)
- The display continuously shows two bars with decimal points: Light sensors on light barrier are dirty or the light barrier is defect. Clean with soft cloth. If the need arises dismount light barrier to clean it. If the switches are defective, the machine can still be used in the manual mode (see 5.2.13)
- PCB is possibly faulty - then exchange

### 7.3.3 Drive motor does not run

- Display "E1" or "E3": see "Error messages" see 5.5
- If current can be registered on motor, then motor is defect - replace it.
- Dryer fan runs but no voltage on motor: exchange power PCB.

### 7.3.4 Display shows error message "E2"

- Check plugins between main drive motor and power PCB. If "E2" appears again, then exchange main drive motor. In rare cases the PCB causes the error (see "Error messages" 5.5)

## 7.4 Baths

### 7.4.1 No circulation in bath

- Circulation pump runs but no circulation can be registered. Air lock in heating and circulation system. To ventilate: see "1. Test run" 3.6.1
- Particles in the pump chamber. The pump chamber can be easily opened by removing the four clips. When closing again ensure that the rubber seal is positioned correctly and not damaged
- Pump does not run. Check voltage on the connections X3 and X4 of the power PCB. If no voltage can be registered, see "Mains switch "ON" – no function" see 7.2.1. If however voltage can be registered, exchange pump.

### 7.4.2 Developer bath temperature is not reached

- No circulation
  - Circulation pump has no current or is defective.
  - Air in circulation system: see "1. Test run" see 3.6.1).
- Check temperature safety switch on heat-exchanger. For temperatures up to 90°C, the temperature limiter must have current passage.
- Check heating element: Current flow resistance should read approx. 66 Ω.
- Check temperature sensor: Voltage at X25 on the control unit between pin 3 (green) and pin 2 (brown). The value should read 0.32 V at a temperature of 32 °C.
- Increase the temperature and check the current on the control unit of clip X13. Voltage should be between mains and 60 Volts. If this is not the case, exchange the electronics.

### 7.4.3 Developer bath temperature is higher than the set temperature, display shows two crossbars, developer temperature button blinks

- see above
- Check current on power PCB at clip X13. There may be no current. If current is registered, exchange electronics.

### 7.4.4 Developer bath temperature too high or too low (display shows values of 20 °C or 42 °C)

- Check temperature sensor. Sensor is either not connected or defective.

### 7.4.5 Calibration of bath temperature / actual bath temperature is different from displayed value

Differences between displayed temperature and measured value in the developer bath can be adjusted. An adjustment may be necessary for example after exchanging the bath temperature sensor. A calibration has to be done, if the difference is higher than +/- 0.5 °C. Adjustment range is +/- 2 °C.

#### 7.4.5.1 Calibration process

- 1 Switch processor off. While pressing developer temperature button switch machine on. Display will show developer bath temperature measured by sensor.
- 2 Measure actual temperature inside developer bath using a calibrated thermometer.
- 3 At first adjust displayed value in 1-degree-steps using the arrow buttons and. To adjust the decimal, hold developer temperature button down and press resp. arrow-button.
- 4 Switch machine off again.

## 7.5 Film defects

### 7.5.1 Films will not dry

- Hot air comes out of air channel, but the film is still not dried to satisfaction.
- Check chemicals and film type. If this leads to no solution then the transport speed of the machine can be reduced (see Processing time, see 5.2.5.2).

### 7.5.2 The film does not transport correctly

- Check the positioning of the racks in the machine and make sure that the latches are closed. Check the gears on the roller racks. Check the positioning of the guide bars and roller pressure.
- Check gears on motor and worm gear of drive shaft-

### 7.5.3 Scratches, pressure marks, dirt on film

- Straight scratches in infeed direction suggest a fault on the guide bars. Check roller racks individually and adjust guide bars. In case the guide bars are damaged exchange.
- Pressure marks caused due to polluted or damaged rollers. If necessary exchange rollers.

## 7.6 Replenishment

### 7.6.1 Replenishment pump does not work or works insufficiently

- Check the switch position on the pump
- Clean valves inside connection tube of pump



### CAUTION!

**Install valve-insert correctly: Pay attention to flow-through direction!**

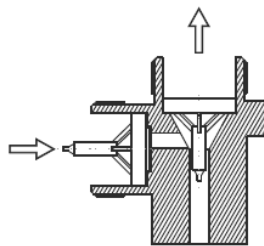

- Replenishment pump sucks air in. Check hoses and connections.
- Check eccentric position. Capacity approx. 710 ml/min (850 ml/min with 60 Hz power mains) at setting to 100%. Minimum setting must not be below 50 %.
- Activate replenishment (in the manual mode) and while on, check the voltage of connection X6 (DEV) and X7 (FIX) on the power PCB. If no voltage can be registered - exchange power PCB.

## 7.7 Dryer

### 7.7.1 Display shows error message "E4"

Following parts should be checked and if faulty be replaced:

- Power PCB (in stand-by no voltage at X12)
- Temperature sensor see "Dryer temperature display exceeds the set value" 7.7.5
- Dryer fan (see "Dryer ventilation does not function, no water inflow when water cock opened" see 7.7.2 and see "Dryer ventilation is too weak" 7.7.3)
- Dryer heating element

### 7.7.2 Dryer ventilation does not function, no water inflow when water cock opened

- Start machine in manual mode (see 5.2.13). Check current on X9 and X10 connections on power PCB. If no voltage can be registered - exchange power PCB. Otherwise ventilation has been connected wrongly or is defective.

### 7.7.3 Dryer ventilation is too weak

If the ventilation is connected incorrectly, it runs very slowly (heating element in the air channel starts to glow).

Dryer ventilation connection:

X9	L	black
X9	Z	brown
X10	N	blue
X10	PE	yellow/green

### 7.7.4 Dryer temperature cannot be reached

- Check temperature sensor: Measure voltage at X24 on the power PCB between pin 3 (green) and pin 2 (brown). The value should read 0.32 V at a temperature of 32 °C.
- Only cold air flows from air channel: Heating element in air channel is defective. Disconnect X12 clip on the power PCB and measure resistance of heating element (approx. 26Ω).
- Enter dryer temperature of 70 °C. Check voltage of X12 on power PCB. If no voltage can be registered exchange control unit.

### 7.7.5 Dryer temperature display exceeds the set value

- Check temperature sensor: Measure voltage at X24 on the power PCB between pin 3 (green) and pin 2 (brown). The value should read 0.32 V at a temperature of 32 °C.
- Enter dryer temperature of 35 °C. Check voltage of X12 on power PCB. If no voltage can be registered exchange control unit.

### 7.7.6 Dryer temperature cannot be reached or is too high (display shows values approx. 30 °C and 75 °C)

- Check temperature sensor. Sensor is either not connected or defective.

## 7.8 Water

### 7.8.1 Rinsing water does not flow

- The water pressure in the water supply system is too low: Minimum pressure 2 bar (29 psi)
- Valve activates, no flow passage - filter at inflow is blocked.
- Check solenoid valve.

### 7.8.2 Water tank overflows

- Water drain hose (overflow) should have a constant fall. The hose end should be positioned above the drainage level in the syphon
- Check water drain line to the tank, hose and connection for residues
- When extreme algae growth is noticed, the overflow can be connected directly at the back of the water tank

## 8 Spare Parts and schematics

### 8.1 Spare Parts

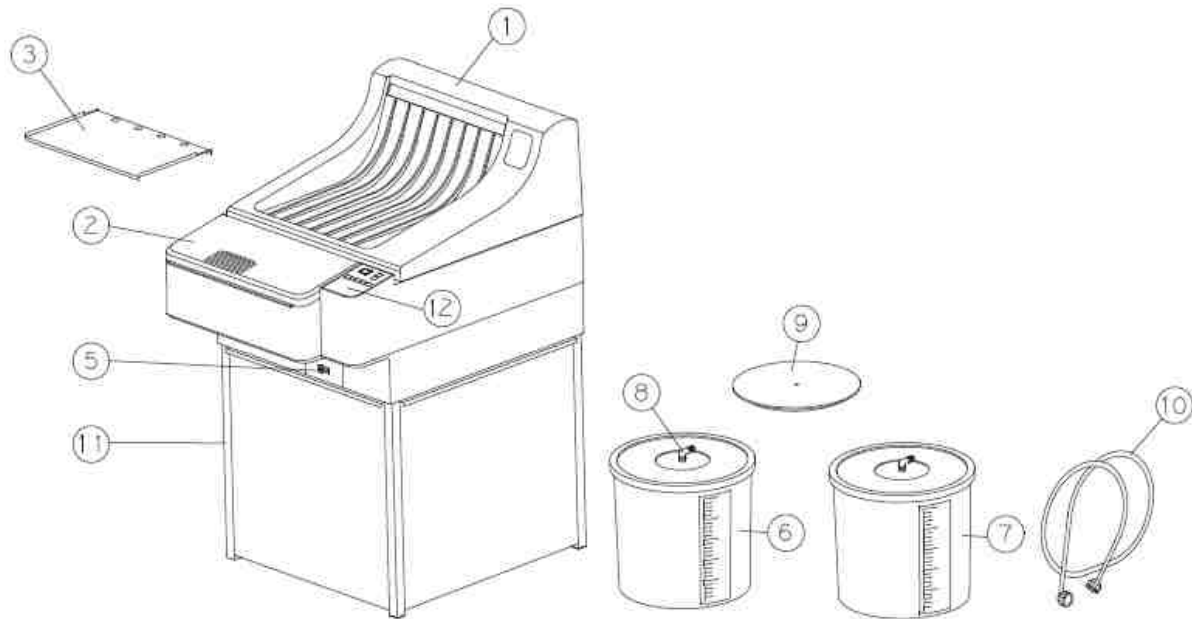

Pos.	Order No.	Description
1	1190-0-0200	Machine cover
2	1190-0-3101	Light protection cover
3	1190-0-0105	Film feed tray
5	2006-0-0005	Drain stop cock 10mm
6	1101-0-2000	Replenishment container 25l E
7	1101-0-2100	Replenishment container 25l F
8	1101-0-1700	Suction pipe for 25l replenishment container
9	1101-0-4100	Floating cover developer
10	2018-0-0001	Water inlet tube
11	1190-0-0011	Processor base cabinet(closed)
	1190-0-0010	Processor base stand (open)
12	1190-0-1201	Control panel foil
-	2018-0-0005	Tube 4 x 1 mm, green
-	2018-0-0021	Tube 9 x 2 mm, red transparent
-	2018-0-0022	Tube 9 x 2 mm, blue transparent
-	2018-0-0007	Tube 16 x 4 mm, clear, reinforced
-	2018-0-0008	Tube 10 x 2 mm, red, reinforced
-	2018-0-0009	Tube 10 x 2 mm, blue, reinforced
-	2018-0-0012	Tube 10 x 2 mm, clear, reinforced
-	2022-0-0014	Tube clamp Snap
-	2022-0-0019	Wire tube clamp
-	2022-0-0026	Wire tube clamp
-	2022-0-0028	Wire tube clamp
-	2022-0-0030	Wire tube clamp
-	1101-0-4600	Floating balls 300 pcs.
-	1101-0-4800	Floating balls 200 pcs.
<b>Wires and cables</b>		
-	1190-0-0108	Transformer – power PCB 20V
-	1190-0-0112	Power PCB - transformer 230V
-	1190-0-0110	Power PCB – controller PCB
-	1190-0-0111	Motor – controller PCB

-	1190-0-0114	Fuse holder – controller PCB
-	2004-0-0010	Electrical power lead
-	2004-0-0012	Main switch – fuse holder

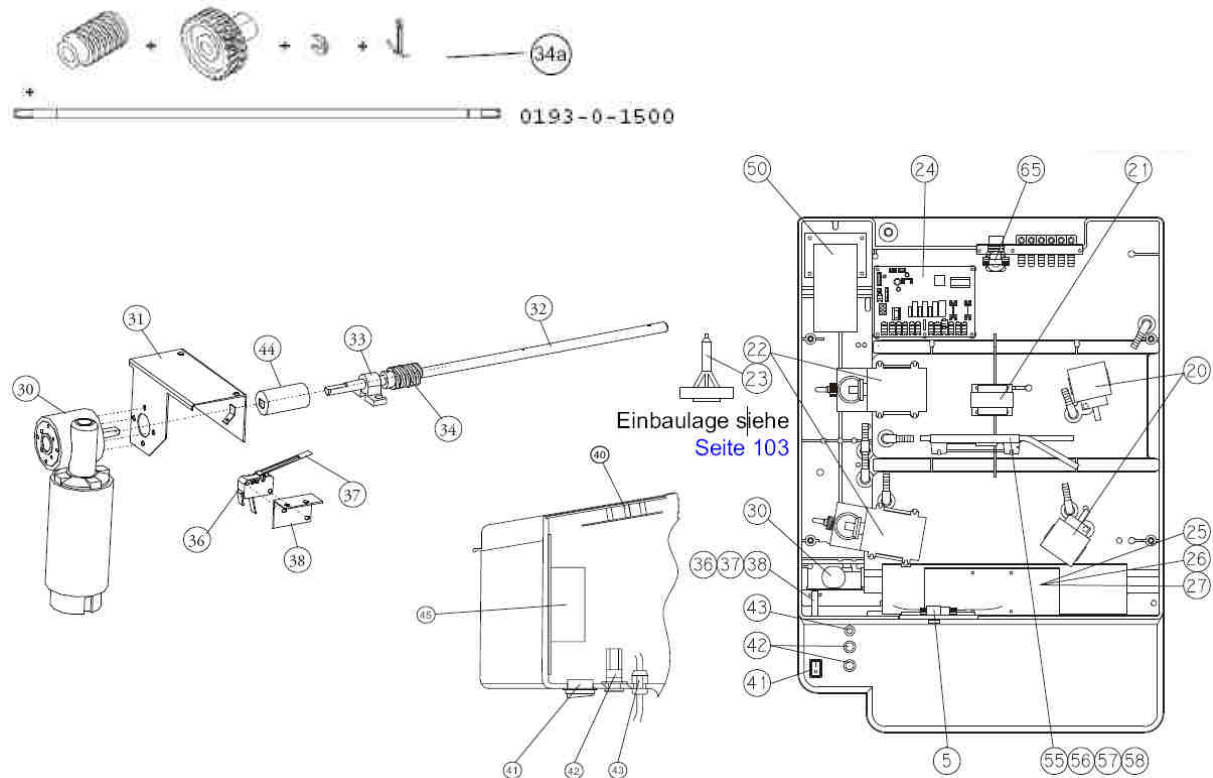

Pos.	Order No.	Description
20	0202-5-0023	Circulation pump
21	2036-1-0001	Safety-transformer
22	0202-5-0021	Bellow pump 50/60Hz
23	0002-5-0019	Back valve for Pos.22
24	0190-0-0900	Power PCB
25	2008-5-0006	Axial fan
26	0190-0-1801	Fan plate
27	1190-0-1802	Light protection plate
30	2001-9-0006	Main drive motor
31	1190-0-1102	Motor bracket, variation 2
32	1190-0-1503	Drive shaft, variation 2
33	1170-0-1502	Bearing block
34	1193-0-1503	Worm gear NDT
34a	0193-0-1500	Worm gear kit NDT
36	0170-0-2400	Micro switch with operator
37	2007-0-0010	Operator for micro switch
38	1190-0-0902	Bracket for cover switch variation 2
40	0190-9-1200	Controller PCB
41	2028-0-0023	Power switch
42	2010-0-0004	Fuse holder
-	2010-0-0010	Fuse slow blow in gold, T 10A/250V
43	2027-0-0012	Traction relief
44	1190-0-0117	Coupling
45	1190-0-0904	Mains filter

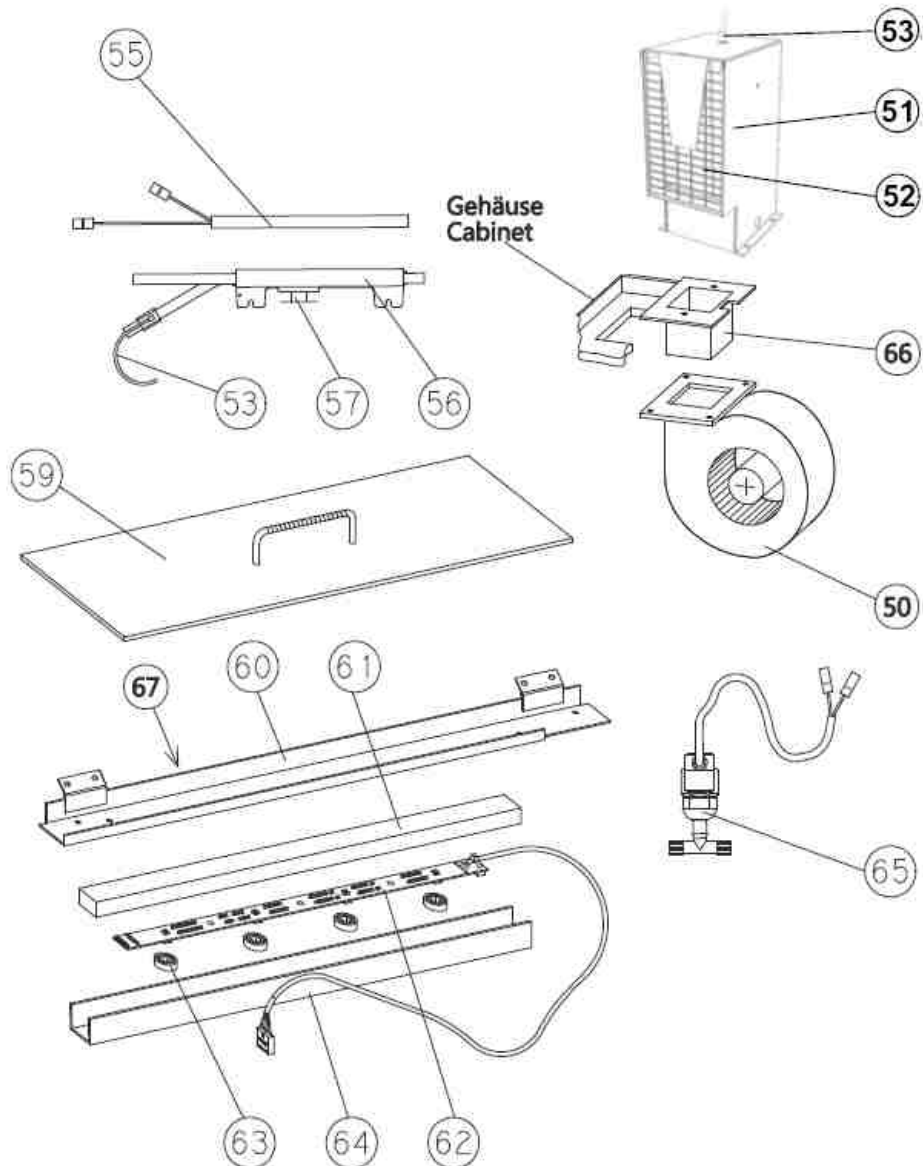

Pos.	Order No.	Description
50	2008-5-0007	Ventilation 230V (dryer)
51	1190-0-1301	Air channel
52	0190-0-1300	Heating element 2kW/230V (dryer)
53	0190-0-2200	Temperature sensor (same for bath and dryer heating)
55	2003-5-0002	Heating element (bath heating) 800W / 230V
56	1190-0-2101	Heat exchanger
57	2005-0-0005	Temperature limiter
59	1190-0-4100	Condensation cover E
60	1190-0-0103	Light barrier support
61	2030-0-0014	Rubber inlet
62-63	0190-0-0800	Light barrier board
64	1190-0-0107	Light barrier casing
65	1120-5-1900	Solenoid valve 230V
66	1190-0-1304	Channel dryer heating
67	1190-0-3102	Light seal

Entwickler rot /Developer red

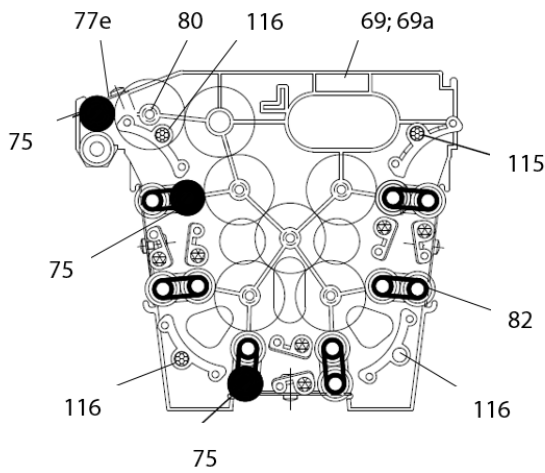



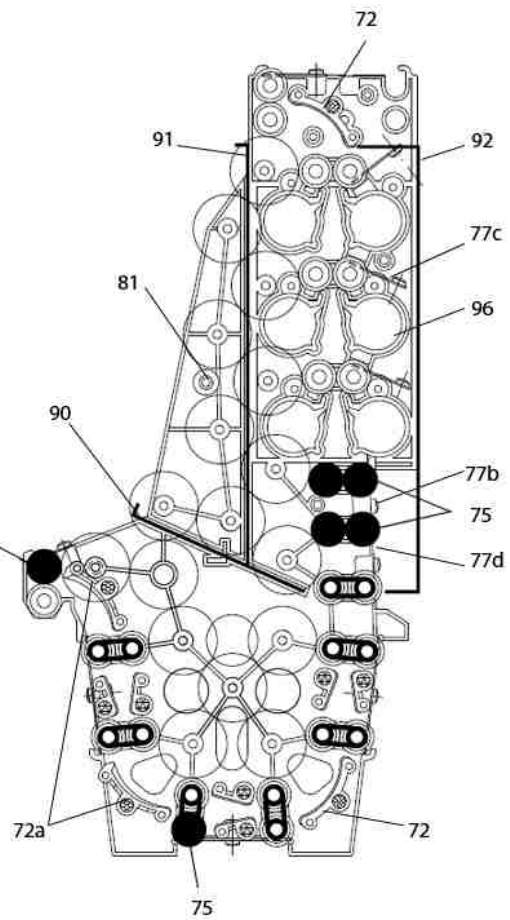
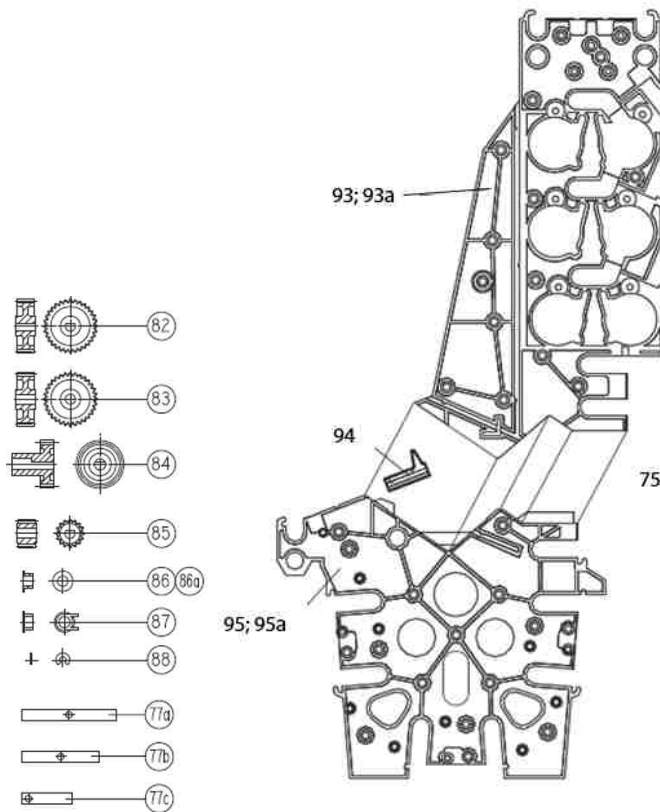
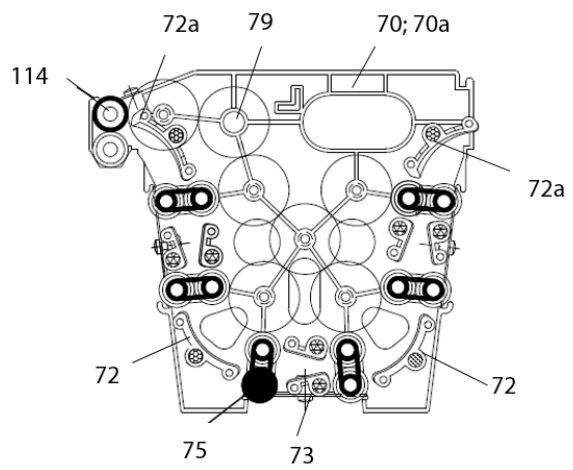



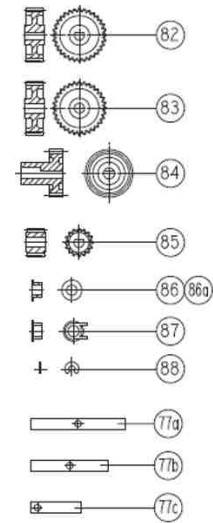

Fixierer blau / Fixer blue



Wasser / Trockner; Water / Dryer



-  NDT Walze 1193-0-0307
-  Gummiwalze 1101-0-0307
-  PU-Walze 0101-0-0306
-  Leitschiene 2 geb. m. Nase 1101-0-4500
-  Leitschiene 2 gebogen 1101-0-3700
-  Leitschiene gerade 1190-0-3600
-  Laufbuchse m. Abstand 1102-0-0401
-  Leitschiene 2 gebogen mit Nase ohne Rippen 1101-0-4000

Pos.	Order No.	Description
	1193-0-0300	Developer Rack C2 NDT
	1193-0-0400	Fixer Rack C2 NDT
	1193-0-0610	Dryer Rack C2 NDT
	1193-0-0620	Water Rack C2 NDT
69	1190-0-0301	Side plate developer (right)
69a	0190-0-0301	Side plate developer with shafts (left)
70	1190-0-0401	Side plate fixer (right)
70a	0190-0-0401	Side plate fixer with shafts (left)
72	1101-0-3700	Guide bar 2, curved
72a	1101-0-4500	Guide bar 2, curved with nose
73	1190-0-3600	Guide bar straight, short
74	1101-0-0306	PU-roller ground
75	1101-0-0307	Rubber roller
77a	1190-0-0302	Flat spring 68
77b	1170-0-0304	Flat spring 55
77c	1170-0-0303	Flat spring 36
77e	1190-0-0303	Flat spring 26
79	1190-0-0310	Drive shaft COMPACT 2
80	1101-0-0316	Shaft
81	1101-0-0311	Distance bar
82	1101-0-0303	Gear t = 32 D-hole
83	1101-0-0304	Gear t = 32 R-hole
84	1170-0-0302	Worm wheel
85	1101-0-0302	Gear t = 16 D-hole
86	1101-0-0305	Bearing bush, white
86a	1101-0-0317	Bearing bush, black
87	1102-0-0401	Bearing bush with clearance
88	2014-0-0001	Circlip
90	1190-0-0604	Dryer plate, small
91	1190-0-0603	Dryer plate, large
92	1190-0-0605	Dryer plate, rear
93	1190-0-0609	Side plate D top right
93a	0190-0-0608	Side plate d top left (with shafts)
94	1190-0-0607	Slide for dyer separation
95	1190-0-0606	Side plate W/D bottom right
95a	0190-0-0606	Side plate W/D bottom left (with shafts)
96	1120-0-0605	Air duct channel
114	1193-0-0307	NDT roller
115	1101-0-4000	Guide bar 2, curved, with nose, without rips
116	1101-0-3900	Guide bar 2, curved, without rips



### CAUTION!

**To maintain constantly good film quality the NDT-roller (upper roller of first roller pair of fixer rack) has to be changed every 3 - 6 months, depending on the quantity of films processed, the chemicals and films used. These rollers must be considered wear parts and are excluded from the guarantee.**

## 8.2 Tips and Tricks

### 8.2.1 Removal of control PCB

To reach the screws of the operating panel module remove the film covering the keyboard in the front area by about 20mm (lift up).

### 8.2.2 Adjusting the software – sub-versions

Before installing the power control unit, set the software sub-version at DIP switch on the controller.

SW1	SW2	SW3	SW4	Variant	Motor (via SW1)	Software sub-versions
OFF	OFF	OFF	ON	Standard	X	22

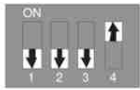

22

### 8.2.3 Stop start-cycle

The start cycle (after switching the machine on) can be manually interrupted. To stop start-cycle, press both arrow-buttons (2+3) simultaneously. The start-cycle may only be interrupted for service purposes.

### 8.2.4 Display of machine information

When during the start-up cycle one of the arrow-buttons is pressed the various machine information will be displayed.

Arrow button "Up": At the beginning for three seconds the machine type (C2) and then for five seconds the software version will be displayed.





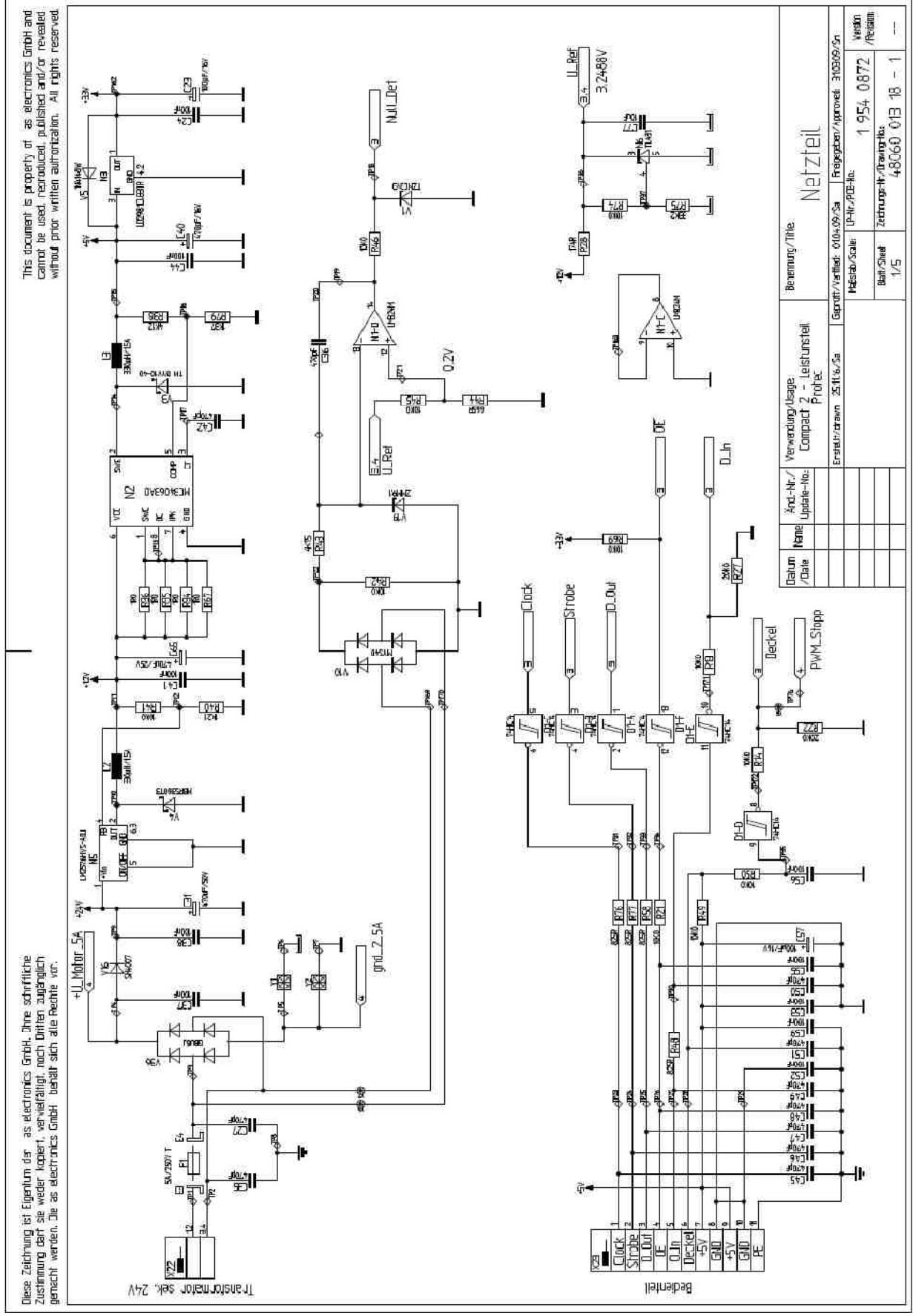

Diese Zeichnung ist Eigentum der as electronics GmbH. Ohne schriftliche Zustimmung darf sie weder kopiert, vervielfältigt, noch Dritten zugänglich gemacht werden. Die as electronics GmbH behält sich alle Rechte vor.

This document is property of as electronics GmbH and cannot be used, reproduced, published and/or revised without prior written authorization. All rights reserved.

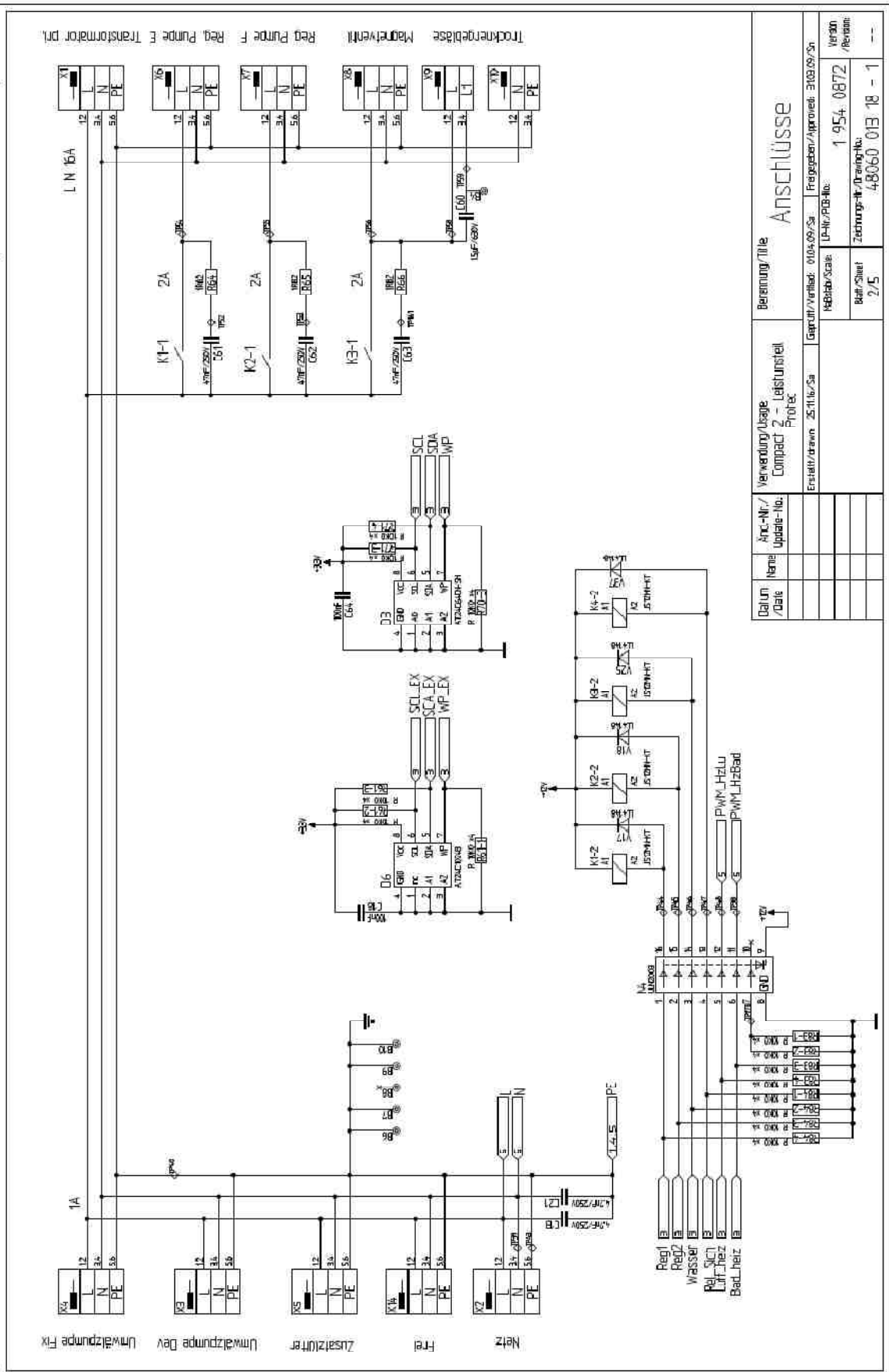

Datum /Date	Name	Art.-Nr. / Update-No.	Verwendung/Usage	Bearbeitung/Title
			Compact 2 - Leistungsteil Frontek	ANSchlüsse
			Erstellt/drawn 25.11.18/Sa	Geprüft/verified: 01.04.09/Sa
				Freigegeben/Approved: 31.03.09/Sa
				Maßstab/Scale: 1:1
				Version /Revision: 1 954 0872
				Baufl./Sheet: 2/5
				Zeichnungs-Nr./Drawing-No.: 48060 01B 18 - 1

V

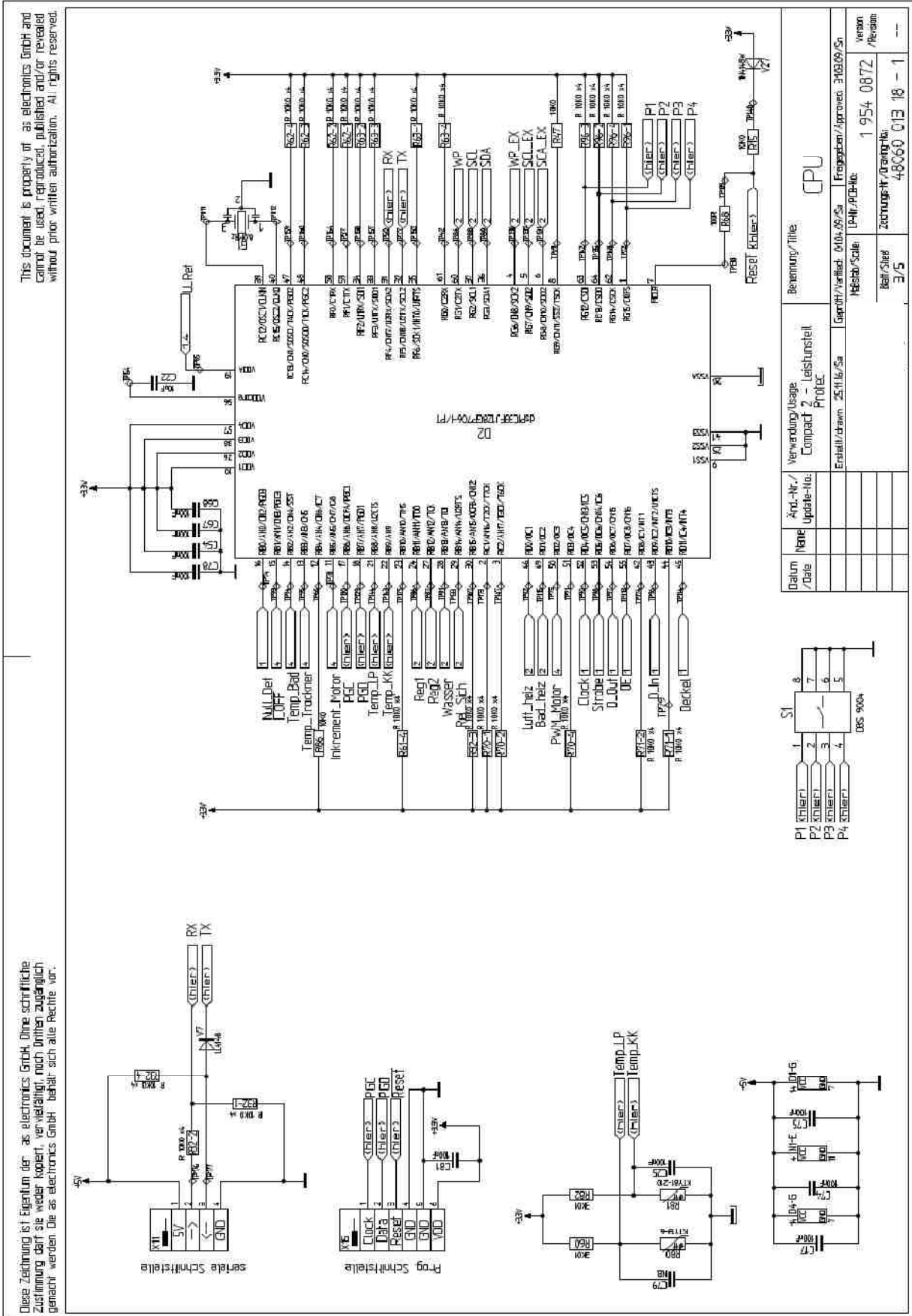

This document is property of as electronics GmbH and cannot be used, reproduced, published and/or revealed without prior written authorization. All rights reserved.

Diese Zeichnung ist Eigentum der as electronics GmbH. Ohne schriftliche Zustimmung darf sie weder kopiert, vervielfältigt, noch Dritten zugänglich gemacht werden. Die as electronics GmbH behält sich alle Rechte vor.

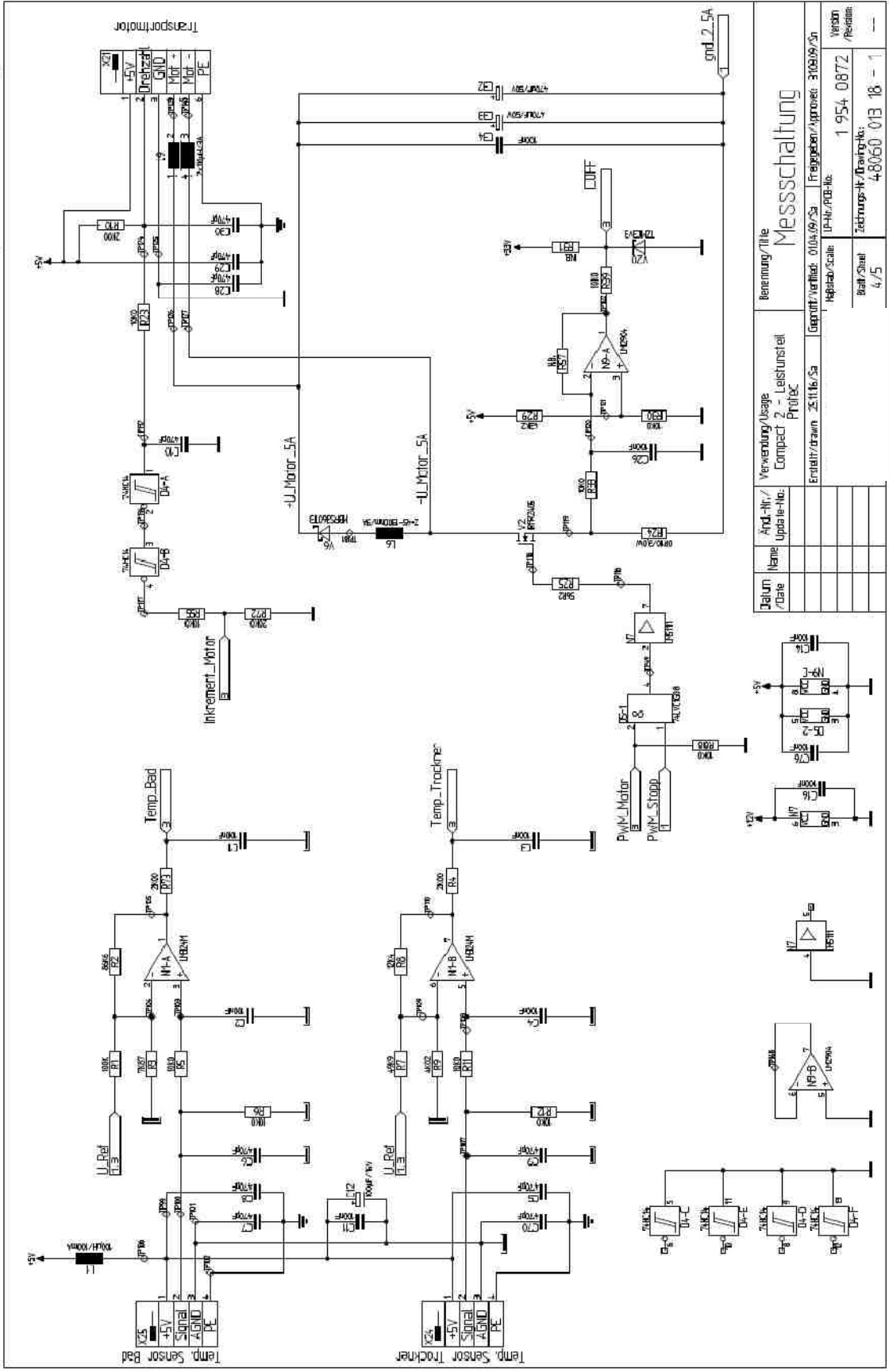

Teilung /Date	Andr.-Nr. / Update-No.	Verwendungsbezug / Compact 2 - Leistunsteil ProfBC	Benennung/Title
		Erstellt/drawn 25.11.16_Sa	Messschaltung
		Geprüft/verified 01.04.19_Sa	U-Hilz/PB-No.
		1954-0872	Zeichnungs-/Drawing-No.
		4/5	Blatt/Sheet
		48060 013 18 - 1	Version /Revisions

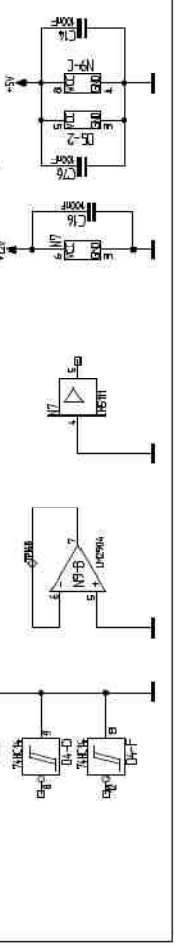



This document is property of Protec X-ray electronics GmbH and cannot be used, reproduced, published and/or revealed without prior written authorization. All rights reserved.

Diese Zeichnung ist ausschließlich unser Eigentum. Ohne vorherige schriftliche Zustimmung darf sie weder wiedergegeben noch Dritten zugänglich gemacht werden. Wir behalten uns alle Rechte vor.

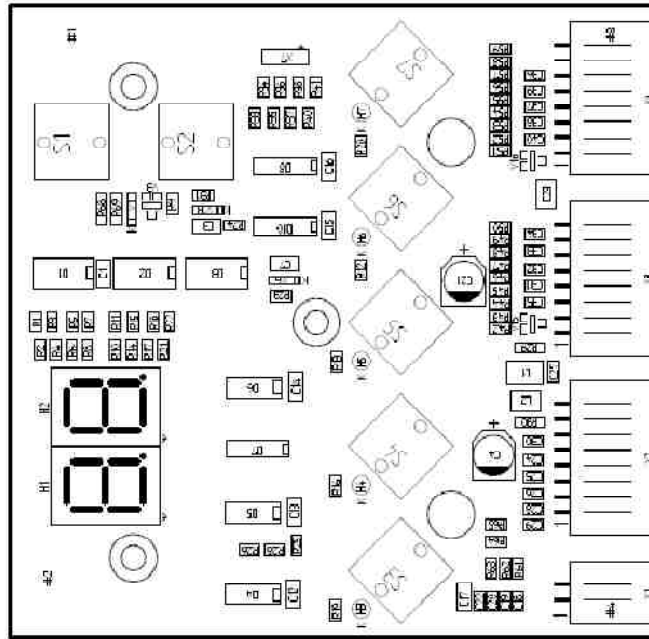

- Layer Top / Layer Oben / BS
- Layer Bottom / Layer unten / LS
- Bestückungsplan Top
- Bestückungsplan Bottom
- Bestückungsdruck Top
- Bestückungsdruck Bottom
- Lithstop Oben/Solder Mask Top
- Lithstop Unten/Solder Mask Bottom
- Paste Mask Top
- Paste Mask Bottom
- Bohrplan / Drill Drawing
- Layer III / Inneplatte 1
- Layer III / Inneplatte 2
- III

Name		Verwendung / Usage		Benennung Title	
And-Title		Compact 2		Bedienhilfe	
Date		B Blatt / Drawn: 04.06.08/lo		Folienplatten - Approval: 04.06.08/lo	
		Tape: 1		UR/DR: 1	
		Hauptstab/Scale: 1:1		UR/DR: 1	
		Blatt/Sheet: 1		UR/DR: 1	
		Zeichnungs-Nr./Drawing-No.: 480960 009 00-2		UR/DR: 1	



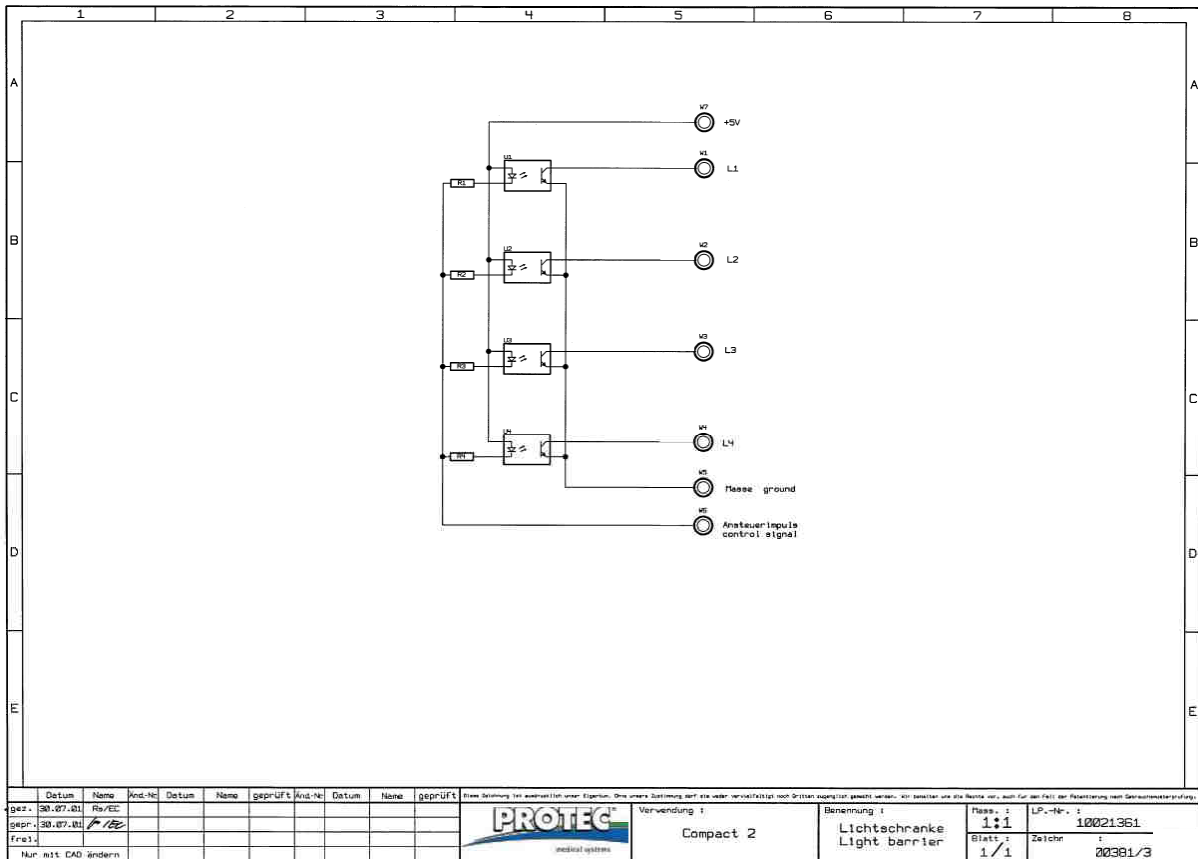
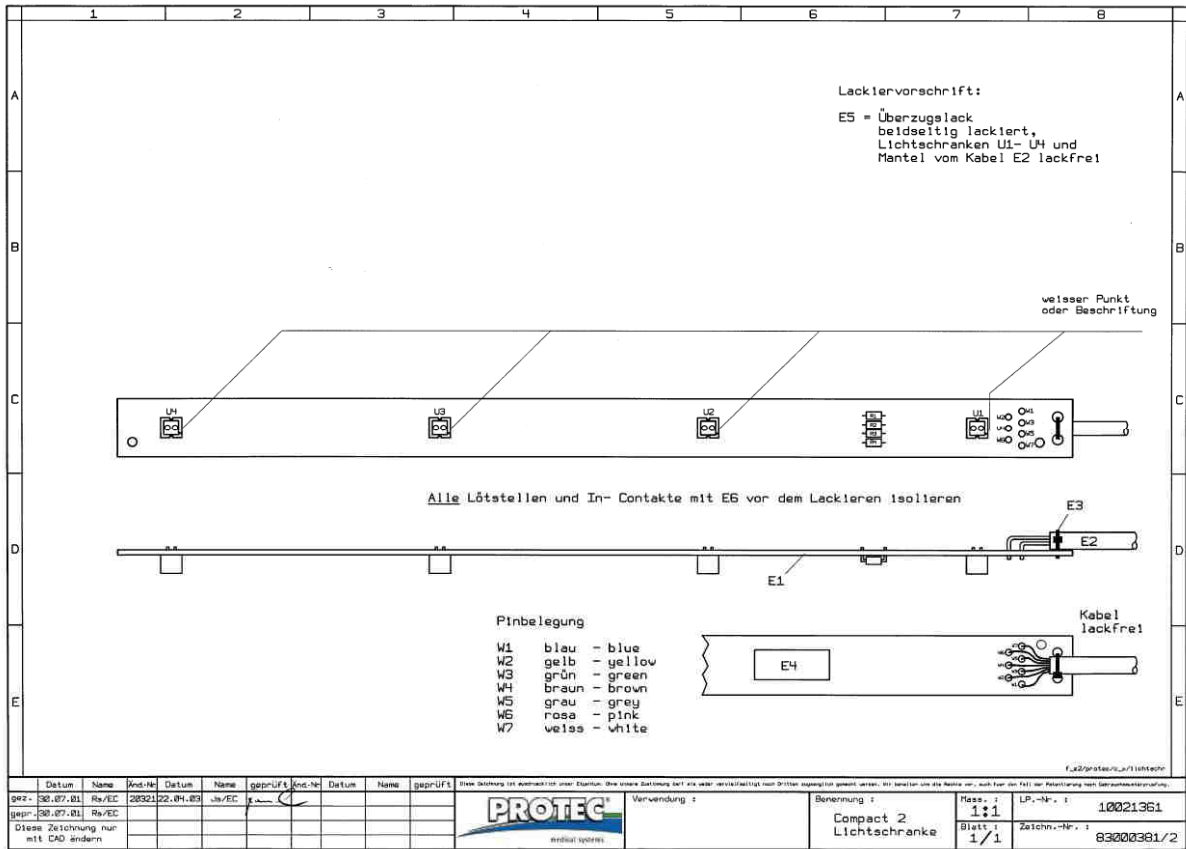

## 9 Power Supply

### 9.1 Electrical connections

Electrical specifications are indicated on model nameplate.

Type 119x-1-x000	230 V ~ +/-10%, 11A, 50Hz
Type 119x-2-x000	230 V ~ +/-10%, 13A, 60Hz

Machine tested for overvoltage category II according to IEC 1010 (EN 61010, VDE 0411).

### 9.2 System protection

IP 20

### 9.3 Power consumption

Stand-by	0.23kWh
Max. by processing	2.8kWh



#### **WARNING!**

**To lower the risk of an electrical shock, the device can only be run on a power supply with a protective conductor.**

---

## 10 Technical specifications

Film transport	Continuous roller transport system
Film formats	In general: sheet films up to max. 45.1cm(17.7 ") width; Smallest film format 10x20 cm (4x8"), 20cm (8") Infeed length, max. 3 films side by side, min. 5cm distance between the films
Processing capacity	174 films 24x30 cm, crosswise, (10x12 ") shortest processing time
Processing time	2 -10 min.; adjustable in steps of 0.1-min.
Linear speed	15.5 -76 5 cm/min., depending on selected process time
Developer time	28 - 142 sec, depending on selected process time
Tank capacities:	12.5 l developer, 12 l fixer, 13l water
Circulation system	Developer and fixer are continuously circulated by a circulation pump
Replenishment	Automatic by film surface measurement in relation to processed film; quantity adjustable; time replenishment can be activated.
Developer temperature	Adjustable 26 - 40 °C (78.8 - 104 °F)
Fixer temperature	Adjusted to developer temperature by heat exchanger
Dryer temperature	Adjustable 35 -70C° (95-158°F), temperature achieved depends on main voltage
Water connection	Permissible water pressure 2 - 10 bar (29 - 145 psi), permissible water temperature 5 - 30 °C (41 - 86 °F)
Water consumption	1.9 litres per minute (0.5 gal/min) when processing.
Drain capacity	11 litres per minute
Noise level	Less than 59 dB(A)
Heat emission	During processing approx.. 1.5kJ/s.
Pollution degree	2
Weight (processor)	Empty 77 kg/*91kg (170/*200 lbs) Filled 115 kg/*129 kg (254/*284 lbs)
Dimensions (LxWxH)	97 x 68 x 127cm (38.2x26.8x50")
Floor space required	0.67 m <sup>2</sup> (7.2 sqft)

\* Values with closed base cabinet.

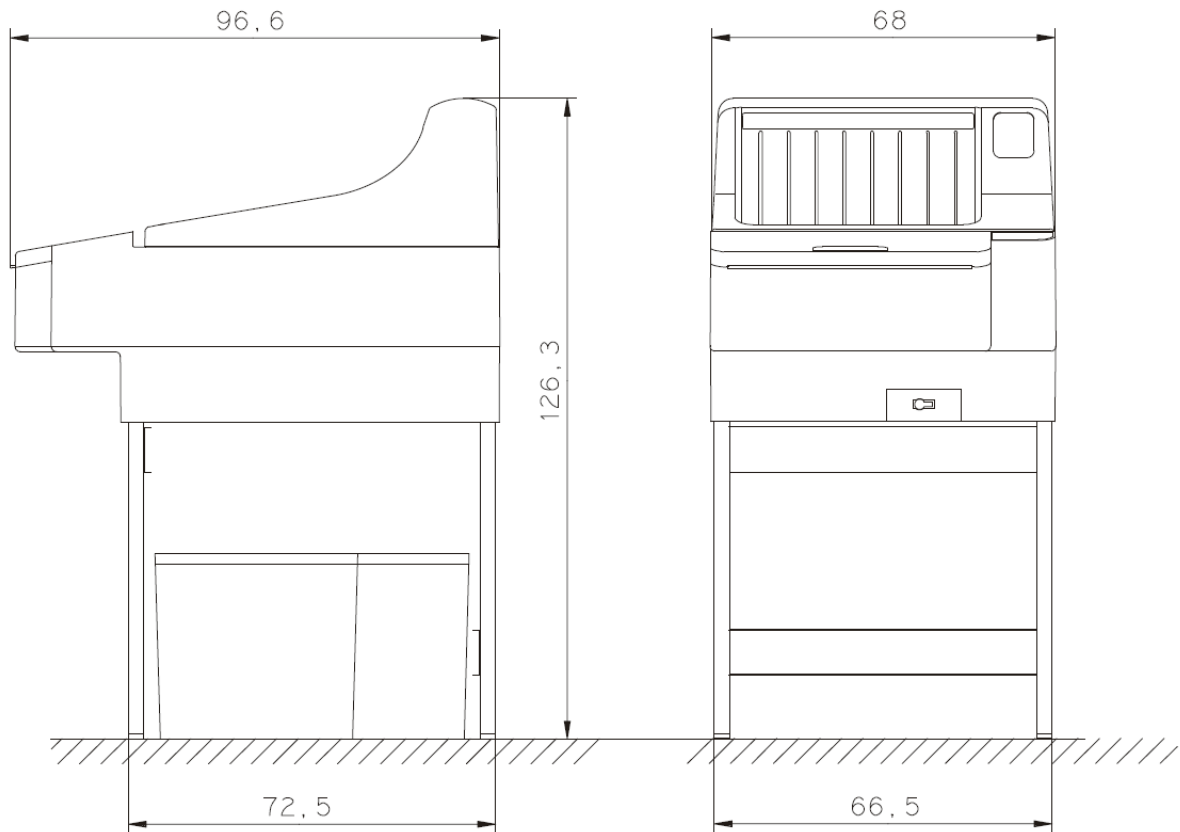

### 10.1 Protection Art and Protection Class

The automated X-ray film processor consistent with a protection class 1.

### 10.2 Environmental

#### 10.2.1 Environmental conditions during operation



















Use	Only indoor
Ambient Temperature	Temperature 18 - 40 °C (51.6 - 104 °F), ventilated room, room temperature should be lower than set bath temperature.
Relative humidity	Relative humidity lower than 80% up to 31 °C (80 °F), linear decreasing to 50% at 40°C (104°F)
Atmospheric pressure	Height above sea level less than 2000 m (6666 ft.)











#### 10.2.2 Environmental Conditions for Shipping and Storage

Ambient Temperature	- 10°C to + 70°C
Relative humidity	10% to 95% (non-condensing)
Atmospheric pressure	500 hPa to 1060hPa

# 11 Description of symbols, labels and abbreviations

## 11.1 Symbols

	Limitation atmospheric pressure
	Limitation temperature
	Limitation humidity
	Keep dry
	Fragile, Handle with care
	This way up
	Attention, consult accompanying documents
	CE-Mark
	Manufacturer
	Trade name
	Order number
	Serial number
	Date of manufacture
	With this symbol we point out that Usage instructions of the corresponding product is on our Homepage
	Notes on disposal; WEEE , Waste of Electrical and Electronic Equipment
	Protective ground (Earth)
	Warning of electrical voltage
	Warning in front of hot surface
	Display working parameters

	Arrow button „up“ increase parameter value
	Arrow button „down“ decrease parameter value
	Symbol processing time
	Symbol developer temperature
	Symbol dryer output
	Symbol replenishment time developer
	Symbol replenishment time fixer
	Replenishment
	Overflow
	Drain

### 11.2 Identification label

50Hz

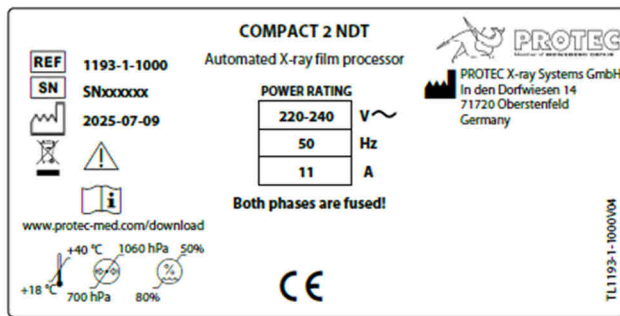

60Hz

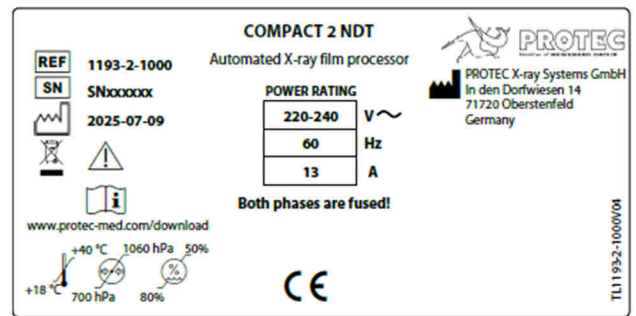

### 11.3 Labels

Corporate



### Control panel foil

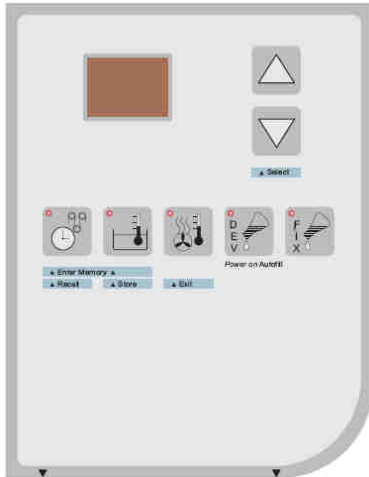

### Designation hose connections



### Description of the fuse

2x T / sb  
10A 250V

### Sticker water pressure

Wasseranschluß: Zulässiger Wasserdruck 2-10 bar  
 Water connection: Permissible water pressure 2-10 bar  
 Arrivée d'eau: Pression nécessaire de 2 à 10 bars  
 Conexión de agua: Presión admisible del agua: 2-10 bares  
 Connessione acqua: Pressione ammissibile dell' acqua: 2-10

### Sticker on the floor plate



Pull plug

### Water outlet



Water outlet open or closed

### 11.4 Position symbols and labels

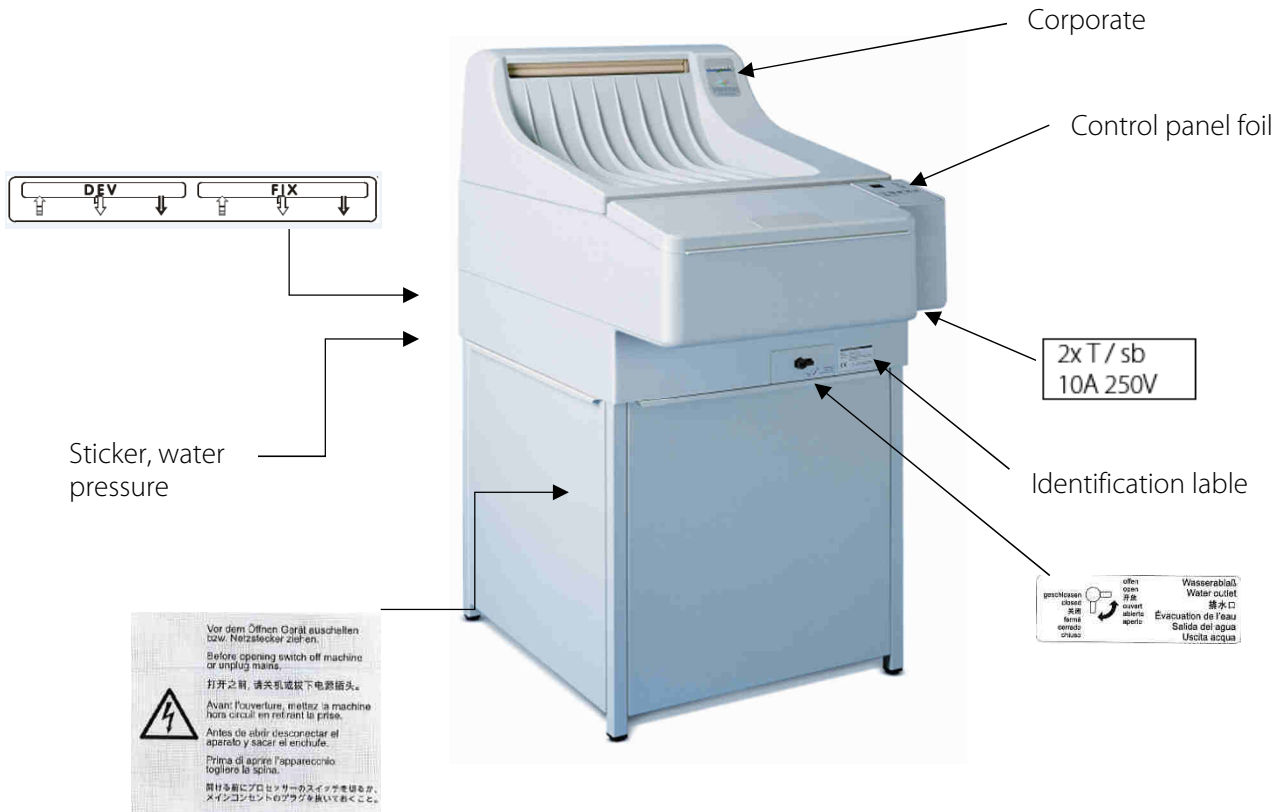

### 11.5 Abbreviations

mm	Millimeter
cm	Centimeter
lb.	Pound
kg	Kilogram
°C	Degree –Celsius
hPa	Hectopascal
DIN	German Industry Standard
EN	European Standard
CE	CE-Mark
Hz	Hertz
ED	Duty cycle
A	Ampere
SN	Serial number