

PROGNOST XP, XPE & XPE-Akku

Basic diagnostic X-ray system table, non-powered or powered

Model/ID: 7036-0-17xx

Basic UDI-DI: 426050264X009ZT

Model/ID: 7037-x-17xx

Basic UDI-DI: 426050264X011ZE

Model/ID: 7038-9-17xx

Basic UDI-DI: 426050264X024ZP

Instructions for use

ID No. 5038-0-0002



**Figure PROGNOST XPE-Akku*

CE

**NOTE**

All sheets of this document contain proprietary and confidential information of PROTEC X-ray Systems GmbH and is intended for exclusive use by current PROTEC X-ray Systems GmbH customers. Copying, disclosure to others or other use is prohibited without the express written consent of PROTEC's law department. Knowledge of violations of these regulations must be reported immediately to PROTEC X-ray Systems GmbH.

© 2025 PROTEC X-ray Systems GmbH, Oberstenfeld

Comments and questions about the documentation, please contact:

PROTEC X-ray Systems GmbH

In den Dorfwiesen 14 | 71720 Oberstenfeld

Germany

Phone: (+ 49) 7062 – 92 55 0

Fax: (+ 49) 7062 – 92 55 60

E-Mail: protec@protec-med.com

Internet: www.protec-med.com

Table of contents

	Page
Table of contents	3
Revision Status	6
General Notes	7
Mechanical and Electric Warning	7
To the User	7
1 Device Description	8
1.1 Introduction	8
1.2 Description.....	8
1.2.1 Versions	8
1.2.1.1 PROGNOST XP	8
1.2.1.2 PROGNOST XPE	8
1.2.1.3 PROGNOST XPE-Akku	9
1.2.2 Hardware and Network System Requirements	9
1.2.3 Installation	9
1.2.3.1 Floor Loading Capacity.....	10
1.3 Performance Characteristics	10
1.3.1 X-ray System Table PROGNOST XP.....	10
1.3.2 X-ray System Table PROGNOST XPE & PROGNOST XPE-Akku	10
1.4 Intended Use	10
1.5 Clinical Benefit	11
1.6 Patient Target Group(s).....	11
1.7 Medical Conditions to be diagnosed.....	11
1.8 Indications and Contraindications	11
1.9 Intended User Group.....	11
1.10 Declaration of Conformity.....	11
2 Safety Instructions	12
2.1 General Safety Instructions	13
2.1.1 Requirements for operation	13
2.1.2 Device Operation	13
2.1.2.1 Operating Type	13
2.1.3 Operating Personnel	13
2.1.4 Crushing and Collision Hazard	13
2.1.4.1 PROGNOST XP	13
2.1.4.2 PROGNOST XPE & XPE-Akku.....	14
2.1.5 Explosion Protection	14
2.1.6 Interaction with Other Devices.....	14
2.1.7 Electromagnetic Environment and Influencing of Devices	14
3 Control Elements and Displays	16
3.1 Main Switch of the PROGNOST XP-series	16
3.2 Emergency Stop Switches of the PROGNOST XP-series.....	16
3.2.1 Emergency Stop Switch PROGNOST XP	16
3.2.2 Emergency Stop Switch PROGNOST XPE & PROGNOST XPE-Akku	16
3.3 Control Elements and Displays of the PROGNOST XP-series.....	16
3.3.1 Control Elements and Displays PROGNOST XP	16
3.3.1.1 Brake Rollers	17
3.3.1.2 Brake Bracket for the Tabletop.....	17
3.3.1.3 Hand Grips (optional)	17
3.3.1.4 Lateral Edge Protection (optional)	17
3.3.1.5 Shock Protection Profile (optional)	17
3.3.1.6 Center Stop (optional)	17
3.3.2 Control Elements and Displays PROGNOST XPE & PROGNOST XPE-Akku	18
3.3.2.1 Brake Rollers	18

3.3.2.2	Brake Bracket for the Table Top.....	18
3.3.2.3	Hand Grips (optional)	18
3.3.2.4	Fixing Mechanism (optional)	19
3.3.2.5	Deflector (optional).....	19
3.3.2.6	Lateral Edge Protection (optional)	19
3.3.2.7	Shock Protection Profile (optional)	19
3.3.2.8	Protection Foil (optional).....	19
3.3.2.9	Center Stop (optional)	19
3.3.3	Emergency Stop Switch and Status Indication.....	20
3.3.3.1	Acoustic Status Indications.....	21
3.3.3.2	Acoustic and Visual Status Indications at Column Drive Blockage	22
3.3.4	Hand Control.....	23
4	Handling	25
4.1	Requirements before and during Operation.....	25
4.2	Operation of the PROGNOST XP-Series.....	25
4.2.1	Operating of the PROGNOST XP	25
4.2.1.1	Releasing the tabletop brake and positioning the tabletop.....	25
4.2.1.2	Exposures with the PROGNOST XP	25
4.2.2	Operating of the PROGNOST XPE & PROGNOST XPE-Akku.....	26
4.2.2.1	Releasing the tabletop brake and positioning the tabletop.....	26
4.2.2.2	Height adjustment of the table top	26
4.2.2.3	Table heights - Zero balance performance	27
4.2.2.4	Saving and setting preferred table heights	27
4.2.2.5	Exposures with the PROGNOST XPE & PROGNOST XPE-Akku.....	27
4.2.3	Specifications for PROGNOST XPE-Akku Operation.....	28
4.2.3.1	Energy Saving Mode	28
4.2.3.2	Battery Box	28
4.2.3.3	Battery Charge Level	30
4.2.3.4	Battery Box Charging Station.....	30
4.2.3.5	Charging the Battery Box	31
4.2.3.6	Charging Cycle and Meaning of the Charging Control LED	32
4.3	Functions of the PROGNOST XP-Series	32
4.3.1	Switching the PROGNOST XP device on and off.....	32
5	Safety and Maintenance.....	33
5.1	Introduction	33
5.2	Reusability	33
5.3	Cleaning and Disinfection	33
5.3.1	Cleaning.....	33
5.3.2	Disinfection	33
5.4	Inspection and Maintenance.....	34
5.4.1	Daily Monitoring before and during the Examination Operation.....	34
5.4.2	Regular Monitoring	34
5.4.2.1	Quality control by the operator	34
5.4.2.2	Safety-related Controls	34
5.4.3	Maintenance	35
5.4.4	Warranty.....	35
5.4.5	Product Service Life	35
5.4.6	Further Information	35
5.4.7	Applied Parts and Parts Considered as Applied Parts.....	35
5.4.8	Disposal Notes	35
6	Power Supply	36
6.1	PROGNOST XPE.....	36
6.2	PROGNOST XPE-Akku.....	36
6.3	Electromagnetic Compatibility (EMC) according to EN 60601-1-2	37
6.3.1	Guidelines and Manufacturer's Declaration – Electromagnetic interference.....	37
7	Technical Data.....	40
7.1	Dimensions.....	40

7.1.1	Dimensions PROGNOST XP.....	40
7.1.2	Dimensions PROGNOST XPE.....	40
7.1.3	Dimensions PROGNOST XPE-Akku.....	41
7.2	Attenuation Equivalent.....	42
7.2.1	Protection Type and Protection Class.....	42
7.3	Environmental Conditions.....	42
7.3.1	Environmental Conditions during Operation.....	42
7.3.2	Environmental Conditions for Shipping and Storage.....	42
8	Description of Symbols, Labels and Abbreviations.....	43
8.1	Symbols.....	43
8.2	Type Label.....	45
8.2.1	Type Label PROGNOST XP.....	45
8.2.2	Type Label PROGNOST XPE.....	45
8.2.3	Type Label PROGNOST XPE-Akku.....	45
8.3	Labels.....	46
8.3.1	Labels PROGNOST XP.....	46
8.3.2	Labels PROGNOST XPE.....	47
8.3.3	Labels PROGNOST XPE-Akku.....	48
8.4	Positions of the Signs and Labels.....	49
8.4.1	Positions of the Signs and Labels PROGNOST XP.....	49
8.4.2	Positions of the Signs and Labels PROGNOST XPE.....	50
8.4.3	Positions of the Signs and Labels PROGNOST XPE-Akku.....	50
8.5	Abbreviations.....	51

**NOTE**

The information contained in this document conforms to the configuration of the equipment as of the date of manufacture. Revisions to the equipment subsequent to the date of manufacture will be addressed in service updates distributed to the PROTEC Technical Service Organisation.

Revision Status

Revision	Date	Updated pages	Comments	Author
1.0	2021-05-17	all	Original issue XP-series (MDR Layout)	MB
1.1	2022-05-13	Chap. 1.4	Translation corrected	ML
2.0	2022-08-03	Chap. 8 Chap. 3.3.3 Chap. 3.3.3.1 Chap. 3.3.3.2	Labels USA and Canada deleted Note (when starting up for the first time, the status LED lights up red 8x) added, Error messages via signal LED and acoustic signals adapted to the revised PROGNOST control	ML
3.0	2022-10-26	Chap. 3.3.1, 3.3.2 Chap. 7.1.2, 7.1.3 Chap. 4.2.2	Fig. and labeling changed because of new handle, tolerances for tables height displacement no longer considered Information about zero balance performance during initial commissioning added.	TB
4.0	2022-12-07	Chap. 1.2.1	Optional accessories corrected	ML
5.0	2023-06-30	Chap. 7.3.1; 8,2; 8.4; Fig. 8.4.1; 8.4.2; 8.4.3	Specification updated; type labels updated	ML
6.0	2024-04-12	Chap. 4.2.1.1, 4.2.2.1 7.3.1	Chap. 'Releasing the tabletop brake and positioning the tabletop' added NOTE new	TB ML
7.0	2025-07-15	All	First edition PROTEC X-ray Systems GmbH	ML

General Notes

**WARNING!**

In order to maintain the set and tested requirements of the 60601 series of standards, the ME system must not be modified during its actual operating life.

Mechanical and Electric Warning

**WARNING!**

All of the movable assemblies and parts of this equipment should be operated with care and routinely inspected in accordance with the manufacturer's recommendations contained in the equipment accompanying documents. Maintenance and service is only to be performed by customers authorized by PROTEC X-ray Systems GmbH.

Live electrical terminals are deadly.

Do not remove flexible high-tension cables from X-ray tube cover or high-tension generator and/or access covers from X-ray generator.

For all components of the equipment protective earthing means must be provided in compliance with the national regulations.

Failure to comply with the foregoing may result in serious or fatal bodily injuries to the operator or those in the area.

To the User

**NOTE**

The user of these accompanying documents is required to carefully read through and carefully consider the instructions, warnings and cautions contained therein before starting operation.

Even if you have already operated similar systems, changes in the design, production and functional routine of the system described here may have been made, which have a significant influence on the operation.

Assembly and service works on the system described here must be carried out by authorised and qualified personnel from PROTEC X-ray Systems GmbH. Assembly personnel and other persons who are not employees of the technical service department of PROTEC X-ray Systems GmbH are requested to contact the local branch of PROTEC X-ray Systems GmbH before assembly or service work is started. For assembly and service works, it is necessary to use the "Technical Description" of the product and to observe the points it contains.

**NOTE**

The use of the product with add-on or accessory parts not authorized by PROTEC or other unapproved components is not permitted.

**NOTE**

According to Regulation (EU) 2017/745 of medical devices, all serious incidents related to the device must be reported to the manufacturer and the responsible authority of the Member State where the user and/or the patient is established.

1 Device Description

1.1 Introduction

The instructions for use describe the performance characteristics and operation required for efficient and effective use of the PROGNOST XP-series.

Before you work with a product of the PROGNOST XP-series, the complete instructions for use must be read, especially the Safety Instructions and the chapter Handling.

1.2 Description

The PROGNOST XP-series consist of mobile X-ray system tables with floating table top. The XPE and XPE-Akku variations also have motorized height adjustment of the table.

The table is designated for the installation of an X-ray cassette holder (Bucky or Grid entity), which can be moved manually in the longitudinal direction, an anti-scatter grid and a 3-field measuring chamber for operation with an automatic exposure control unit.

The floating table top is locked in horizontal and vertical direction with a mechanical brake and can be released by a brake bracket.

The wheels of the table can be locked separately by arrester.

1.2.1 Versions

1.2.1.1 PROGNOST XP

Model/ID: 7036-0-17xx

Table frame colour RAL 9003

Table top versions:

Model/ID	Material	L	W	Tabletop color
7036-0-1710	composite fibre	200 cm	65,5 cm	white
7036-0-1711	composite fibre	200 cm	75,5 cm	white
7036-0-1712	composite fibre	226 cm	75,5 cm	white
7036-0-1713	carbon fibre	200 cm	75,5 cm	white
7036-0-1714	carbon fibre	226 cm	75,5 cm	white

1.2.1.2 PROGNOST XPE

Model/ID: 7037-x-17xx

Table frame colour RAL 9003

Table top versions:

Model/ID	Material	L	W	Tabletop color
7037-1-1710	composite fibre	200 cm	65,5 cm	white
7037-1-1711	composite fibre	200 cm	75,5 cm	white
7037-1-1712	composite fibre	226 cm	75,5 cm	white
7037-1-1713	carbon fibre	200 cm	75,5 cm	white
7037-1-1714	carbon fibre	226 cm	75,5 cm	white

*Model/IDs with 6 in the middle (e.g., 7037-6-1710) are operated with 115V

1.2.1.3 PROGNOST XPE-Akku

Model/ID: 7038-9-17xx

Table frame colour RAL 9003

Table top versions:

Model/ID	Material	L	W	Tabletop color
7038-9-1710	composite fibre	200 cm	65,5 cm	white
7038-9-1711	composite fibre	200 cm	75,5 cm	white
7038-9-1712	composite fibre	226 cm	75,5 cm	white
7038-9-1713	carbon fibre	200 cm	75,5 cm	white
7038-9-1714	carbon fibre	226 cm	75,5 cm	white

Optional Components

- X-ray cassette holder (Bucky or Grid entity)
- 3- field measuring chamber (ionization or solid state)
- Anti-scatter grid

Optional Accessories

- Mattress
- Ball knob grab handle, for a fine positioning of the patient on the 4-way table top
- Handle long, for facilitating the positioning and descending of the patient
- Handle short moveable, as operating aid for easy moving of the table top
- Shock protection profile, for rear table top accessory rail
- Compression band
- Fixing mechanism, only for PROGNOST XPE and PROGNOST XPE-Akku
- Center stop, for accurate positioning
- Adaptionset for X-ray cassette holder, only for PROGNOST XPE and PROGNOST XPE-Akku
- Detector holder lateral, incl. 2 handles*

*Accessories with medical purpose

1.2.2 Hardware and Network System Requirements

As a stand-alone product, the PROGNOST XP-series has no hardware or network connection and therefore no hardware or network requirements.

1.2.3 Installation



NOTE

The installation of a PROGNOST XP-series product must be performed by PROTEC service department or a service company authorized by them.

For more information, please see the Installation manual of the corresponding XP-series product.

Contact information of persons qualified to perform installations are available upon request at:

PROTEC X-ray Systems GmbH

In den Dorfwiesen 14 | 71720 Oberstenfeld
Germany

Phone: (+ 49) 7062 – 92 55 0

Fax: (+ 49) 7062 – 92 55 60

E-Mail: protec@protec-med.com

Internet: www.protec-med.com

1.2.3.1 Floor Loading Capacity



NOTE

The products of the PROGNOST XP-series are primarily made of metal pieces. This has a corresponding effect in the weight of the device.

The PROGNOST XP has a weight of 103kg.

The PROGNOST XPE has a weight of 114kg.

The PROGNOST XPE-Akku has a weight of 129kg.

All weights with table top size 2260 x 755 mm.

Every technician is obliged to check the floor load. Raised floors and hollow floors must also be considered.

1.3 Performance Characteristics

1.3.1 X-ray System Table PROGNOST XP

- Floating tabletop
- Table top color white
- Mobile, smooth manoeuvrability
- A low optimized distance from the upper edge of the table top to the film (detector) surface
- Large adjustment range of the table top for positioning the patient
- High reliability
- Lateral profile rails of the table top prepared to attach several table accessories
- Suitable for digital Bucky

1.3.2 X-ray System Table PROGNOST XPE & PROGNOST XPE-Akku

- Floating tabletop
- Table top color white
- Motorized height adjustment of the table top
- Mobile, smooth manoeuvrability
- Automatic stop at pre-programmed table top heights
- A low optimized distance from the upper edge of the table top to the film (detector) surface
- Large adjustment range of the table top for positioning the patient
- High reliability
- Lateral profile rails of the table top prepared to attach several table accessories
- Suitable for digital Bucky

- Battery-supplied accumulator operation via two exchangeable battery boxes (only PROGNOST XPE-Akku)
- Separate battery box charging station (only PROGNOST XPE-Akku)

1.4 Intended Use

The mobile X-ray system table ...

- PROGNOST XP is intended to be used as a component
- PROGNOST XPE is intended to be used as an electrically operated component
- PROGNOST XPE-Akku is intended to be used as a battery-powered component

... of a diagnostic X-ray system for patient positioning for various routine applications in planar X-ray imaging in human medicine.

1.5 Clinical Benefit

Considered in isolation, no clinical benefit can be shown for X-ray system tables.

As components of diagnostic X-ray systems in human medicine, they contribute to the clinical benefit of X-ray systems, which consists of the generation of conventional two-dimensional X-ray images for creation or specification of findings as a basis for treatment decisions.

1.6 Patient Target Group(s)

The intended patient group includes all people for whom a justifying indication for a medical X-ray has been given by a physician with the necessary expertise in radiation protection.

There are no general or fundamental restrictions on the patient group regarding age, gender, origin and patient condition.

1.7 Medical Conditions to be diagnosed

As standalone products, X-ray system tables, have no function to diagnose, treat and/or monitor medical conditions.

1.8 Indications and Contraindications

As standalone products, X-ray system tables have no intended main effect in or on the human body. Therefore, considered in isolation, no indications or contraindications can be shown for them.

1.9 Intended User Group

As a component of a diagnostic X-ray system, products of the PROGNOST XP-series are intended exclusively for use by professional users who are trained in the operation of diagnostic X-ray systems in accordance with the respective national regulations and who are familiar with the proper handling, use and operation and also have been instructed in the permitted conjunction with other medical products, objects and accessories.

Appropriate users can be, for example: X-ray technicians, X-ray assistants, medical technical X-ray assistants, surgeons, casualty surgeons, orthopaedists and other trained medical personnel.

1.10 Declaration of Conformity



This product complies with the requirements of Regulation (EU) 2017/745 of the European Parliament and of the Council of 5 April 2017 on medical devices, including all applicable corrigenda.

The declaration of conformity is available upon request from PROTEC:

PROTEC X-ray Systems GmbH

In den Dorfwiesen 14 | 71720 Oberstenfeld

Germany

Phone: (+ 49) 7062 – 92 55 0

Fax: (+ 49) 7062 – 92 55 60

E-Mail: protec@protec-med.com

Internet: www.protec-med.com

2 Safety Instructions



NOTE

Contains information that must be observed during operation.

xxx



CAUTION!

Contains information which, if not observed, can cause property damage.

xxx



WARNING!

Contains information which, if not followed, can cause personal injury.

xxx



WARNING!

Warning of radioactive substances or ionizing radiation. Contains information which, if not observed, can cause personal injury.

xxx

Settings and calibrations that are not described in these instructions for use must be carried out using the technical description of the device by PROTEC service department or a service company authorized by them.



NOTE

All instructions supplied with the PROGNOST XP-series must be observed and the safety instructions contained therein must be carefully read and adhered to.



NOTE

After the initial installation, the commissioning must be recorded with the PROTEC acceptance protocol FB-04-07A4.



NOTE

The PROGNOST XP product may only be commissioned if all safety measures for operator protection have been met and checked. These protective measures can include door contact, designated area, dosimeter, protective clothing, etc.



CAUTION!

The instructions for use contain all the information relevant to safety in order to generally put the PROGNOST XP product into operation. The device may only be operated by appropriately trained and trained personnel. In this context, operation is ensured by clear symbols on the control elements. All further information and instructions can be found on the supplied data carrier (USB, CD or DVD). This information applies in its entirety as an appendix to these instructions for use and must be observed.



NOTE

All control elements are described again in detail in these operating instructions.

2.1 General Safety Instructions

2.1.1 Requirements for operation



WARNING!

The PROGNOST XPE products are protection class I devices (according to EN 60601-1).

To avoid the risk of an electric shock, the PROGNOST XPE or PROGNOST XPE-Akku may only be connected to a supply network with a protective earthing conductor.

2.1.2 Device Operation

In case of a malfunction, do not use the appropriate PROGNOST XP product anymore and notify PROTEC service department or a service company authorized by them.

2.1.2.1 Operating Type

The PROGNOST XPE and PROGNOST XPE-Akku is not intended for continuous operation.

Duty Cycle: S3 15% - maximum continuous operation of 1,5 minutes.

2.1.3 Operating Personnel



NOTE

Only trained and authorized personnel are allowed to work on the PROGNOST XP device.



NOTE

The operating personnel must be familiar with all warning signs attached to the particular PROGNOST XP product. They are used for your own safety and that of others and ensure proper operation.

2.1.4 Crushing and Collision Hazard



WARNING!

It must be ensured that when operating the moving parts of PROGNOST XP-series, no persons or objects are in the obvious danger area of the device. If not observed, it can result in personal injury or damage to the product of the PROGNOST XP-series or other objects.

2.1.4.1 PROGNOST XP

Pinching of fingers and hands is possible at the points marked with arrows in the picture below. Please ensure that neither the patient nor the personnel are in the movement area in an uncontrolled manner when moving the table or table top.

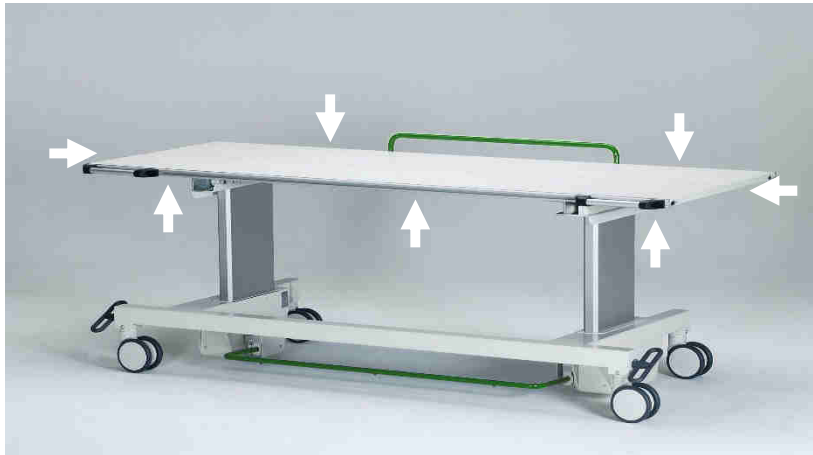

2.1.4.2 PROGNOST XPE & XPE-Akku

Pinching of fingers and hands is possible at the points marked with arrows in the picture below. Please ensure that neither the patient nor the personnel are in the movement area in an uncontrolled manner when moving the table or table top.

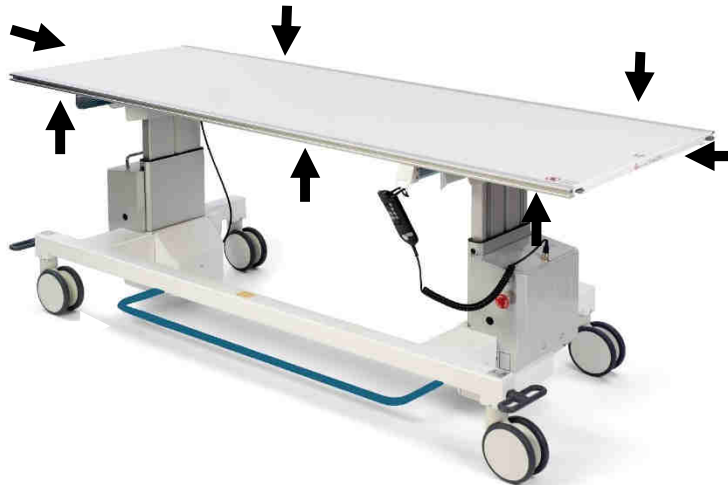

2.1.5 Explosion Protection

The PROGNOST XP-series is not designated for use within areas with explosive hazards.

2.1.6 Interaction with Other Devices

Interactions with other devices are not known.

2.1.7 Electromagnetic Environment and Influencing of Devices



CAUTION!

The use of other accessories, other converters and other cables than those specified by PROTEC or provided in the documentation of the component manufacturer can result in increased electromagnetic interference or reduced electromagnetic immunity of the device and lead to defective operation.

**CAUTION!**

The use of a device of the PROGNOST XP-series immediately next to other devices or with other devices in a stacked form should be avoided, as this could result in defective operation. If use in the manner described above is nevertheless necessary, the PROGNOST XP product and the other devices should be observed to ensure that they are working properly.

**NOTE**

The properties of this device, determined by emissions, allow its use in industrial areas and in hospitals (CISPR 11, class A). When used in residential areas (for which class B is usually required by CISPR 11), this device may not provide adequate protection for radio services. The user may need to take remedial measures such as relocating or realigning the device.

The PROGNOST XP-series is intended for use in an environment in professional health care facilities (e.g., clinics, surgery centres, physiology practices ...).

3 Control Elements and Displays

3.1 Main Switch of the PROGNOST XP-series

All products of the PROGNOST XP-series do not have a main switch.

3.2 Emergency Stop Switches of the PROGNOST XP-series

3.2.1 Emergency Stop Switch PROGNOST XP

The PROGNOST XP does not have an emergency stop switch.

3.2.2 Emergency Stop Switch PROGNOST XPE & PROGNOST XPE-Akku

The PROGNOST XPE and PROGNOST XPE-Akku has the following emergency stop switch, which can be used to bring the device to an immediate standstill and disconnect it from the power supply.

The switch is located on the right side of the table below the table top.



3.3 Control Elements and Displays of the PROGNOST XP-series

3.3.1 Control Elements and Displays PROGNOST XP

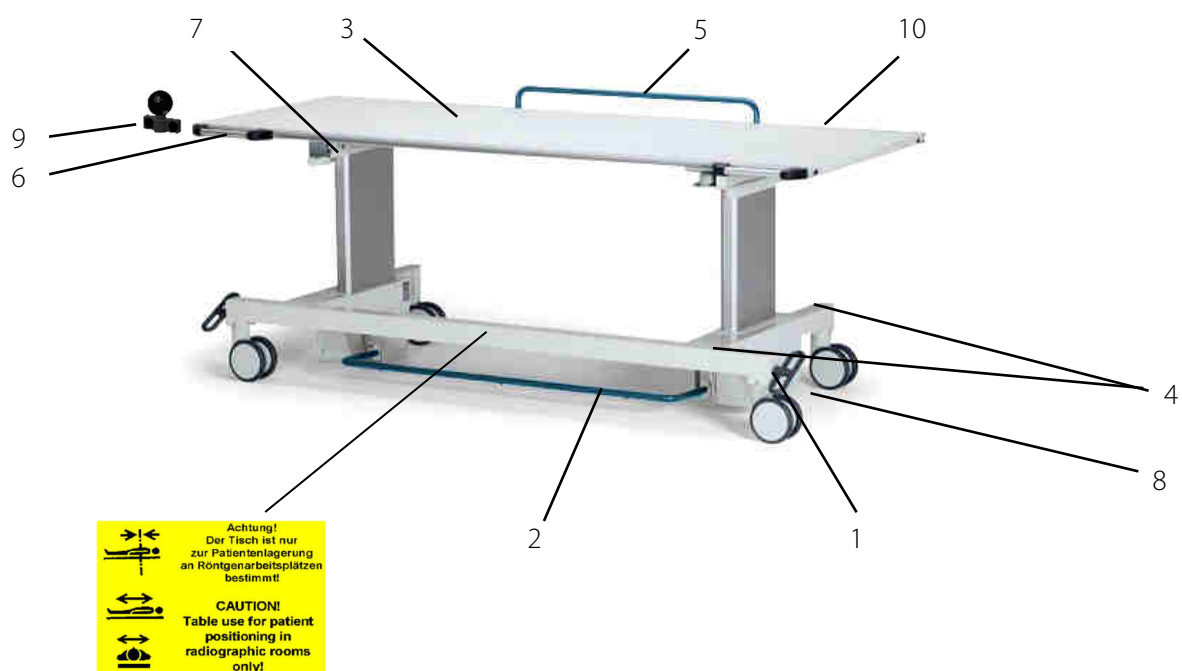

1. Arrester for wheels
2. Brake bracket for table top
3. Table top
4. Type Label, UL label, FDA label, Symbols for the brake
5. Rear side long handle (optional)
6. Front side hand grips (optional, not for a sale with a Bucky)
7. Protection film for internal covers
8. Locking device (optional)
9. Alternative grab handle (optional)
10. Bumper profile (optional)

3.3.1.1 Brake Rollers

In order to fix the table on the floor in all directions, it has 2 brake rollers on the front side, which must be locked with the arrester on the left and right side before a patient gets on or off the table.

3.3.1.2 Brake Bracket for the Tabletop

By operating the brake bracket with the foot, the brakes of the tabletop are released, then the table top can be moved floating by hand.

3.3.1.3 Hand Grips (optional)

A long handle for the back of the table top and 2 handles for the front of the table top are available as options. Both handles can only be removed with tools. The long handle is intended for easier ascending and descending of the patient. The table as well as the table top can be better shifted with the short handles.

3.3.1.4 Lateral Edge Protection (optional)

The lateral edge protection prevents direct contact of the detector housing with the Z-angle bracket.

3.3.1.5 Shock Protection Profile (optional)

The shock profile prevents a direct contact of the rear accessory rail of the table top with the tube column stand or the detector holder.

3.3.1.6 Center Stop (optional)

The center stop for the transverse movement of the table top improves the alignment of the table to the X-ray tube assembly.

3.3.2 Control Elements and Displays PROGNOST XPE & PROGNOST XPE-Akku

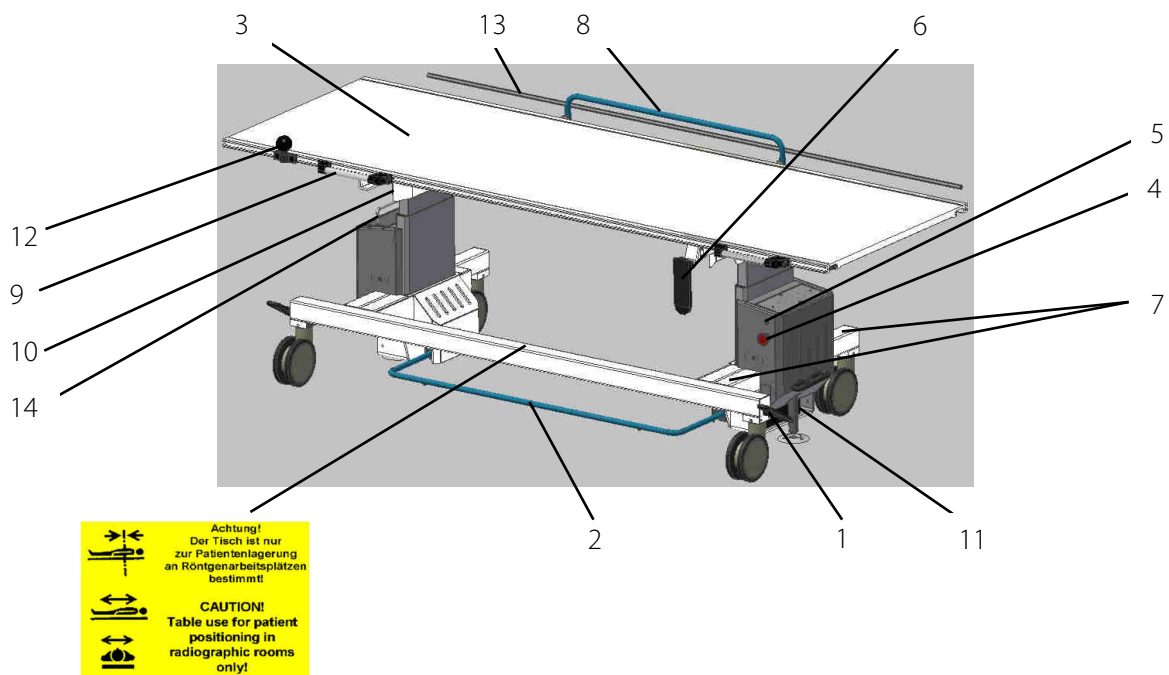

* Figure PROGNOST XPE-Akku

1. Arrester for wheels
2. Brake bracket for table top
3. Table top
4. Emergency stop switch
5. Indicator lamp
6. Hand control and holder
7. Type label, UL label, FDA label, Symbols for the brake
8. Rear side long handle (optional, not for sale with a Bucky)
9. Front side hand grips (optional)
10. Protection foil
11. Locking device (optional)
12. Alternative grab handle (optional)
13. Bumper profile (optional)
14. Rechargeable battery (only in PROGNOST XPE-Akku)

3.3.2.1 Brake Rollers

In order to fix the table on the floor in all directions, it has 2 brake rollers on the front side, which must be locked with the arrester on the left and right side before a patient gets on or off the table.

3.3.2.2 Brake Bracket for the Table Top

By operating the brake bracket with the foot, the brakes of the table top are released, then the table top can be moved floating by hand.

Movement of the table top (from the middle position):

Transverse direction:	$\pm 100 \text{ mm}$
Longitudinal direction:	$\pm 330 \text{ mm}$ (2 m table top)
	$\pm 460 \text{ mm}$ (2,26 m table top)

3.3.2.3 Hand Grips (optional)

A long handle for the back of the table top and 2 handles for the front of the table top are available as options. Both handles can only be removed with tools. The long handle is intended for easier

ascending and descending of the patient. The table as well as the table top can be better shifted with the short handles.

3.3.2.4 Fixing Mechanism (optional)

The PROGNOST XPE product can be equipped with a locking device (detent) mounted on the right or left side.

In addition to precise positioning of the PROGNOST XPE or PROGNOST XPE-Akku in the X-ray examination room, the locking device enables rotation around the corresponding column axis.

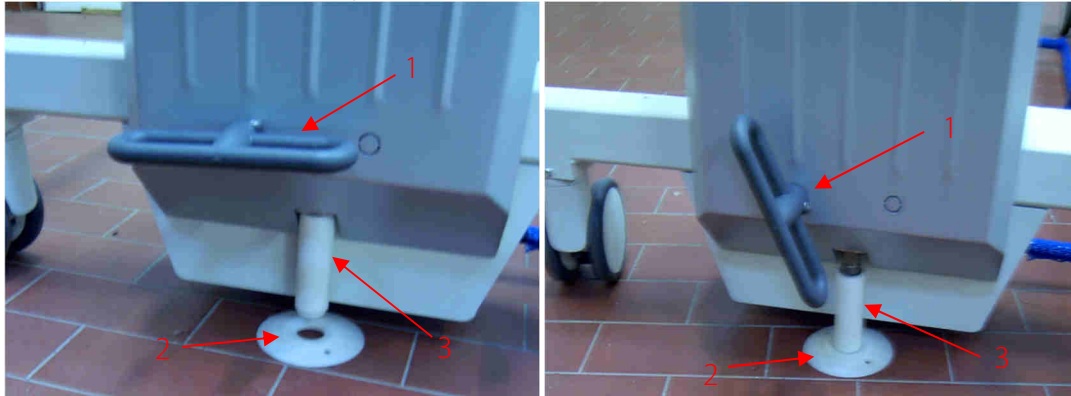

The corresponding device is positioned over the floor-fixed detent disc (2) that the springy plunger (3) engages in the opening of the detent disc by actuating the arrester (1). The detent is released again by actuating the arrester accordingly.

3.3.2.5 Deflector (optional)

The deflectors prevent the U-rail from touching the detector housing and thus facilitate the positioning of the table top above the image receiver.

3.3.2.6 Lateral Edge Protection (optional)

The lateral edge protection prevents direct contact of the detector housing with the Z-angle bracket.

3.3.2.7 Shock Protection Profile (optional)

The shock profile prevents a direct contact of the rear accessory rail of the table top with the tube column stand or the detector holder.

3.3.2.8 Protection Foil (optional)

The protective foil on the inner cover plates increases the sliding properties when in contact with the detector housing.

3.3.2.9 Center Stop (optional)

The center stop for the transverse movement of the table top improves the alignment of the table to the X-ray tube assembly.

3.3.3 Emergency Stop Switch and Status Indication

The control unit and the drive for the height adjustment are switched off by actuating the emergency stop switch.

The emergency stop switch is unlocked by turning it to the right.

Next to the emergency stop there is the three-color signal lamp, which is used to indicate readiness and status messages.



WARNING!

Even if the emergency stop switch has been actuated and the signal lamp is not illuminated, the mains voltage may still be present at the device plug. The table is only safely disconnected from the power supply when the power plug is pulled out of the supply socket.



NOTE

During initial start-up of the X-ray table, the LED display on the front of the table flashes 8 times in red. If the LED does not light up, check whether the emergency stop switch is activated.

Perform a zero adjustment of the lifting columns.

The following is an overview of the signal lamps status indication:

Indicator light color	Status	Product concerned
slight green	Energy saving mode o Operational readiness is activated by pressing the release key	PROGNOST XPE-Akku
green	Device is ready for operation	PROGNOST XPE & PROGNOST XPE-Akku
orange	Battery almost empty o Normal driving function still possible	PROGNOST XPE-Akku
red	Battery empty o Only showing driving function possible o No restart in energy saving mode possible o Battery must be replaced	PROGNOST XPE-Akku
	Error message	PROGNOST XPE & PROGNOST XPE-Akku

Status indications for all XP-series models are given by cyclic flashing of the indicator light in the color red.

State	Flashing rhythm red	Description	Measure
1	1x 	Check DIP switch.	Take the device out of operation and notify PROTEC authorized service.
2	2x 	Drive (lifting columns) blocked, Or: Defective cable or plug is disconnected.	Check whether the table plate is blocked in the downward / upward movement.

			Move the table in the opposite direction of the blockage. If the error message persists, notify PROTEC authorized service.
3	3x 	Overload, excessive patient load and thus excessive current consumption of the drives (lifting columns).	Reduce the patient load and allow the device to cool down at a standstill. If the cause has been eliminated, the status messages can be deleted by briefly pressing the foot switch.
4	4x 	Unintentional movement, e.g., downwards due to impermissibly high patient load.	Reduce the patient load. Notify PROTEC authorized service.
	5x 	DC-DC converter defect	Height adjustment not possible. Take the device out of order and notify PROTEC authorized service
	6x 	Battery empty	Height adjustment not possible. Replace or charge battery
6	8x 	Height difference of the lifting columns, there is 1.5 cm difference in the position (height) of the lifting columns. (When restarting / replacing the board, this error message comes automatically).	Perform zero adjustment Notify a PROTEC authorized service if the error message reoccurs after the zero balance.
7	9X 	Blocking the tabletop brake.	Take the device out of order and notify PROTEC authorized service.
8	10X 	Duty cycle of the lifting columns exceeded.	Allow the device to cool down at standstill until signal LED changes from red flashing rhythm to bright green again.



NOTE

State message 2,4 and 5:

If these state messages can be deleted with the release button and then occur again, the PROTEC authorized service must be notified and the table must be taken out of order.

3.3.3.1 Acoustic Status Indications

For all signal lamps state messages, a one-time acoustic message is given by the built-in beeper.

Beep sound	Meaning	Product concerned
2x 	General warning	PROGNOST XPE & PROGNOST XPE-Akku

3x ⌋⌋⌋	Battery almost empty	PROGNOST XPE-Akku
6x ⌋⌋⌋⌋⌋⌋	Battery empty	PROGNOST XPE-Akku
Continuous	1. Overload, drive current consumption too high (see status message 3 in Chapter 4.3.5.3) 2. Or: Blocking of the table top brake (. See status message 7 in Chapter 4.3.5.3).	PROGNOST XPE & PROGNOST XPE-Akku



CAUTION!

If the drive is blocked during operation, the movement of the height adjustment must be stopped and the obvious blockage of the height adjustment (e.g., due to the table top resting on an object) must be rectified. If the cause of the blockage is not obvious (e.g., internally blocked drive column), the height adjustment must be taken out of order and the service authorized by PROTEC must be notified.

3.3.3.2 Acoustic and Visual Status Indications at Column Drive Blockage

In the event of a blocked column drive, a visual indicator lamp status message is issued in combination with a one-time acoustic warning.

If a height difference of >1 cm between the drive columns is detected by the control, height adjustment is no longer permitted (height adjustment automatically disabled).

A maximum duty cycle (ED) of 15% is prescribed for the drive columns in order to avoid overloading the column and to achieve a long service life. This is implemented in the control system in such a way that the height adjustment of the table is prevented after the factory-set time and an error message (10x flashing, see table) is displayed. This forces a pause of 4 minutes, as no height adjustment can be made. The internal time is then reset that the table height can be adjusted again. In order to have the complete travel time available again, the table must be left switched on for at least 15 minutes without making a table height adjustment.

3.3.4 Hand Control

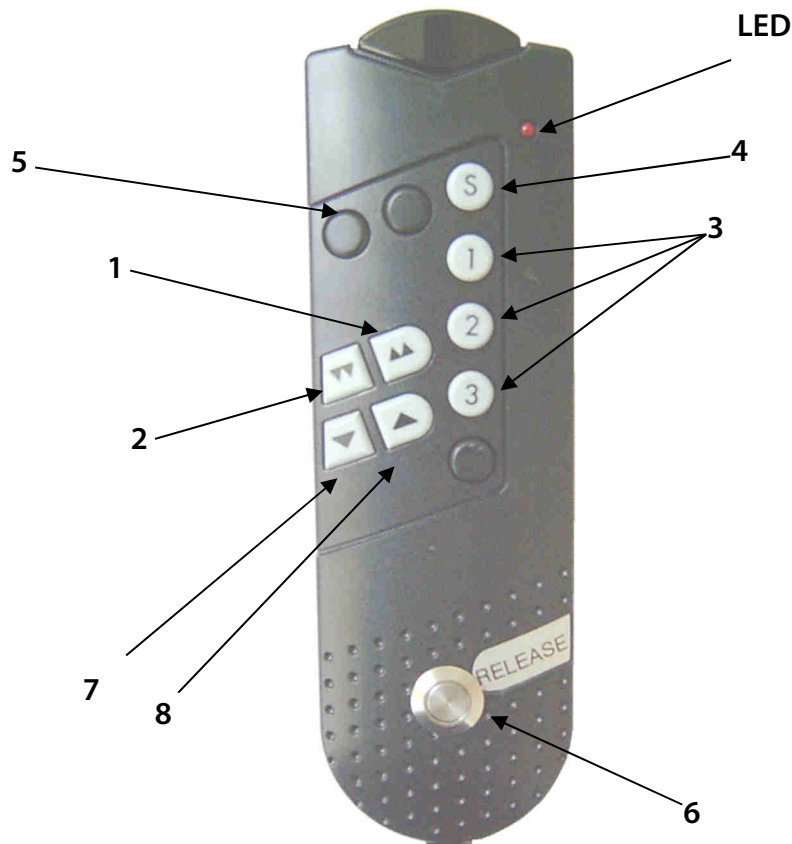

Description of the buttons:

- 1 Move the table top upwards fast, in combination with button 6 (movement release button)
- 2 Move the table top downwards fast, in combination with button 6 (movement release button)
- 3 Move the table top to the stored height, in combination with button 6 (movement release button)
- 4 Store button
- 5 Synchronization adjustment button, to move the table down for synchronization, in connection with button 6 (movement release button)
- 6 Movement release button
- 7 Move the table top downwards slowly, in combination with button 6 (movement release button)
- 8 Move the table top upwards slowly, in combination with button 6 (movement release button)
- LED flashes if a button is pressed

Buttons special functions see Technical Description.



CAUTION!

To carry out a table top height adjustment, it is necessary to permanently press the movement release button (6) before a movement button (1), (2), (7) or (8).

To end the height adjustment, first release the corresponding movement button and after that the movement release button.

Otherwise, the control unit may be damaged.

The hand control must be hooked in the holder if it's not used.

4 Handling

4.1 Requirements before and during Operation

It must be ensured that the surfaces in contact with patients are disinfected before the X-ray examination of each patient (see chapter 5.3.2).

4.2 Operation of the PROGNOST XP-Series

4.2.1 Operating of the PROGNOST XP

4.2.1.1 Releasing the tabletop brake and positioning the tabletop



NOTE

Prior to patient positioning, the X-ray unit must be brought into the required exposure position.



WARNING!

The tabletop may only be locked when the tabletop is in the rest position, not while it is being moved.

1. Release the tabletop brakes by pressing the brake bar with your foot.
2. Move the floating tabletop to the desired position by hand while keeping the brake bar pressed.
3. When the tabletop is in the rest position, release the brake bar and the tabletop will be locked again by the brakes.

4.2.1.2 Exposures with the PROGNOST XP

The following procedure must be observed to prevent collisions with the device, the image receiver or other furniture.

- Move the X-ray unit, e.g., swivel bracket system, to the 0-degree-position.
- Adjust the height of the image receiver to match the height of the table
- Move the table to the intended exposure position for inspection
- Move the table to a position in which the patient can climb onto the table surface as easy as possible
- Operate the arrester for the front brake rollers and check that the rollers are effectively braked



NOTE

The PROGNOST XP is not suitable for patient transport.
It is used only for positioning the patient during the examination.
The patient may only be ascended and descended at the marked positions with the brakes applied and with the supervision or assistance of the examiner, as otherwise there is a risk of tipping over!
The patient must be given assistance when climbing on.

- Position the patient for the exposure. If necessary (e.g., open wounds), cover the table surface with suitable cloths or disposable nursing pads



WARNING!

Danger of crushing at the table edges and danger of trapping underneath the table top.

If the table and the table top are moved horizontally, extremities can be trapped between the edge of the table and a stationary obstacle (wall, column, X-ray unit). Therefore, when moving the PROGNOST XP, make sure that neither the patient nor the personnel are standing in the direction of movement. In particular, make sure that none of the patient's extremities protrude above the table top.

- Release the arrester of the rollers and move the PROGNOST XP to the exposure position
- Lock the arresters again
- Release the table top brake and move the table top with the patient to the exact exposure position and lock the table top brake
- Perform exposures according to the instructions for use of the X-ray unit
- After the examination, release the arresters and move the table to a position that facilitates the patient's descent
- Lock the brakes and assist the patient in getting off the table

4.2.2 Operating of the PROGNOST XPE & PROGNOST XPE-Akku



WARNING!

Perform a zero balance of the lifting columns before initial startup of the X-ray table (see chapter 4.2.2.3)!

4.2.2.1 Releasing the tabletop brake and positioning the tabletop



NOTE

Prior to patient positioning, the X-ray unit must be brought into the required exposure position.





WARNING!

The tabletop may only be locked when the tabletop is in the rest position, not while it is being moved.

4. Release the tabletop brakes by pressing the brake bar with your foot.
5. Move the floating tabletop to the desired position by hand while keeping the brake bar pressed.
6. When the tabletop is in the rest position, release the brake bar and the tabletop will be locked again by the brakes.

4.2.2.2 Height adjustment of the table top

By pressing one of the arrow buttons ,  or  (in combination with the movement release button) on the hand control, the table top can be moved up or down. In the end positions, the drives are stopped automatically.

A maximum duty cycle (ED) of 10% is specified for the drive columns to avoid overloading them and to achieve a long service life. This is implemented in the control unit that after the time specified by the factory, the height adjustment of the table is stopped and an error message is displayed (10x flashing, see table in chapter 3). This forces a pause of 4 minutes in which no height adjustment can be made. Afterwards, the internal time is reset that the adjustment of the table height is possible again (for at least 45 seconds). To use the table for the complete travel time (210 seconds) again, the table must be left in the switched-on state for at least 20 minutes without making a table height adjustment.

4.2.2.3 Table heights - Zero balance performance

At the first commissioning, or if differences in the table top height are visible, the control unit must be referenced.



CAUTION!

If there are visible differences in the table height, the table top could start moving by itself if the brakes are released.

For adjustment, the "S"-button (Store button, see chapter 3) of the hand control must be pressed three times. Afterwards, use the synchronous adjustment button (see chapter 3) to move the table top down until both lifting columns automatically switch off in the lowest position. The control acknowledges this with a beep sound, now the columns are synchronized.



CAUTION!

Never perform a zero balance with a positioned patient!

4.2.2.4 Saving and setting preferred table heights

Three different table heights can be stored, at which the drives stop automatically.

Move the table to the desired height position.

Release the movement release button (see chapter 3).

Press the "S"-button (store button, see chapter 3) three times and actuate button 1, 2 or 3 on the hand control to store the position on one of these buttons.

The process is confirmed with a beep.

To move to the stored table height, press a button 1, 2 or 3 in combination with the movement release button (button 6) until the height adjustment switches off automatically.

4.2.2.5 Exposures with the PROGNOST XPE & PROGNOST XPE-Akku

To use the table, the operator must insert the power plug of the power cord into the designated power supply socket. The mains line must be laid in a way, that no damage can be caused by running over it with the wheels when moving the table.

The following procedure must be observed to prevent collisions with the device, the image receiver or other furniture.

- For exposures with the PROGNOST XPE & XPE-Akku, move the X-ray unit into the intended position
- Adjust the height of the image receiver according to the height of the table or move the table to the correct height



CAUTION!

The electrical height adjustment is designed for short-time operation

- Move the table to the intended exposure position and check that there is no collision between the table top, the table or the image receiver

- Move the table to a position in which the patient can climb onto the table surface as easy as possible
- Operate the arrester for the front brake rollers and check that the rollers are effectively braked
- Assist the patient in climbing up
- Release the arrester of the rollers and move the table to the exposure position
- Lock the arresters again
- Release the table top brake and move the table top with the patient to the exact exposure position and lock the table top brake
- Perform exposures according to the instructions for use of the X-ray unit
- After the examination, release the arresters and move the table to a position that facilitates the patient's descent
- Lock the brakes and assist the patient in getting off the table

**NOTE**

The PROGNOST XPE & XPE-Akku is not suitable for patient transport. It is used only for positioning the patient during the examination. The patient may only be ascended and descended at the marked positions with the brakes applied and with the supervision or assistance of the examiner, as otherwise there is a risk of tipping over!
The patient must be given assistance when climbing on.

4.2.3 Specifications for PROGNOST XPE-Akku Operation

4.2.3.1 Energy Saving Mode

If pauses of more than 20 seconds are made between the individual adjustments of the table height, and if the movement release button is not pressed during that time, the PROGNOST XPE-Akku switches to energy saving mode and thereby extend the use of the battery charge.

The color of the indicator light changes to slight green.

Briefly pressing the movement release button reactivates the operational readiness and exits the energy-saving mode.

The color of the signal lamp changes to light green or to one of the states before the transition to the energy saving mode.

During longer breaks in operation, it is recommended to switch off the PROGNOST XPE-Akku by pressing the emergency stop switch or to disconnect the power supply.

4.2.3.2 Battery Box

Two battery boxes are supplied with the PROGNOST XPE-Akku as basic equipment.

The battery box is a special housing with guides, built-in battery, 25A protection fuse, connection contacts and charging socket.

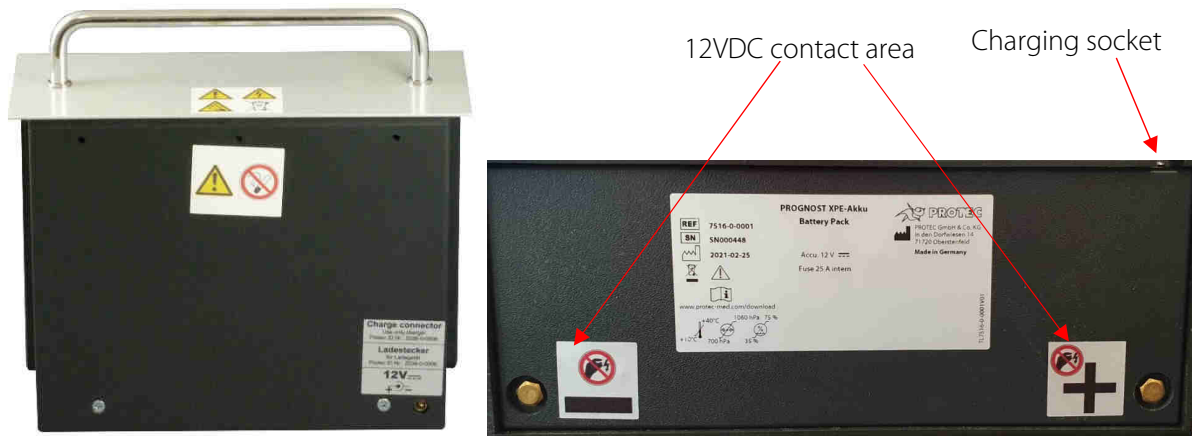

To operate the PROGNOST XPE-Akku, a charged battery box must be inserted into the supply station of the table.



CAUTION!

Before changing the battery box, press the emergency stop switch of the PROGNOST XPE-Akku and only after a fully charged battery box has been inserted, put the device back into operational readiness by releasing the emergency stop switch.



Fuse 20A



The second batter box is charged with the battery box charging station.



CAUTION!

The batter boxes may only be charged with the PROTEC approved charger!

The 20A fuse protecting the 12VDC voltage in the PROGNOST XPE-Akku behind the cover of the power supply station is accessible through the battery box slot.



CAUTION!

The battery box has recessed contact surfaces at the bottom for the 12VDC supply connections to the installed battery.

Never short-circuit the contact surfaces!

Never place a battery box on a metal plate, metallic or conductive objects, otherwise there is a risk of short-circuiting the built-in battery!

As an additional short-circuit protection, there is a 25A fuse in the battery box. If this fuse is defective (no voltage is present at the contact surfaces), the PROTEC authorized service department must be notified for the purpose of checking the PROGNOST XPE-Akku battery.

4.2.3.3 Battery Charge Level

If a battery box in operation has reached the discharge limit, an acoustic warning tone sounds and the indicator light changes from green to orange (this usually occurs if the battery is discharged and the patient is moved upwards).

To ensure continued smooth operation, the discharged battery box should be replaced with a newly charged battery box during the subsequent patient change.



NOTE

If the acoustic and optical discharge warning is not considered, the XPE control unit permits the table height to be adjusted until the discharge safety limit of the battery box is reached.

If this discharge safety limit is reached, further movements are prevented to protect the battery box against deep discharge.

Only by using a newly charged battery box, the operation of the PROGNOST XPE-Akku can be continued.



NOTE

As with all batteries, the maximum charge capacity is reached after several discharge and charge cycles.

All battery boxes are supplied by PROTEC in a charged state.

Before using the PROGNOST XPE-Akku for the first time, the battery boxes should nevertheless be recharged with the battery box charging station.

4.2.3.4 Battery Box Charging Station

The charging station is supplied with the PROGNOST XPE-Akku as basic equipment.



CAUTION!

Only the PROTEC charger may be used. This is also installed in the battery box charging station.

Only PROTEC approved battery boxes may be charged with the charger.

The charging station should be placed that it can be easily reached from the PROGNOST XPE-Akku examination room.



WARNING!

The charger must be placed outside the patient area.



CAUTION!

Explosive gases may be generated while charging lead batteries. Adequate ventilation must be provided and fire or open light must be avoided.

The charger may only be operated in dry rooms. To avoid the risk of fire or electric shock, the charger must be protected from humidity.

Only carry out cleaning work on the charger when the charger has been disconnected from the power supply.

Clean only with a dry cloth. If the housing or the power plug is damaged, do not operate the charger and inform the PROTEC service department.

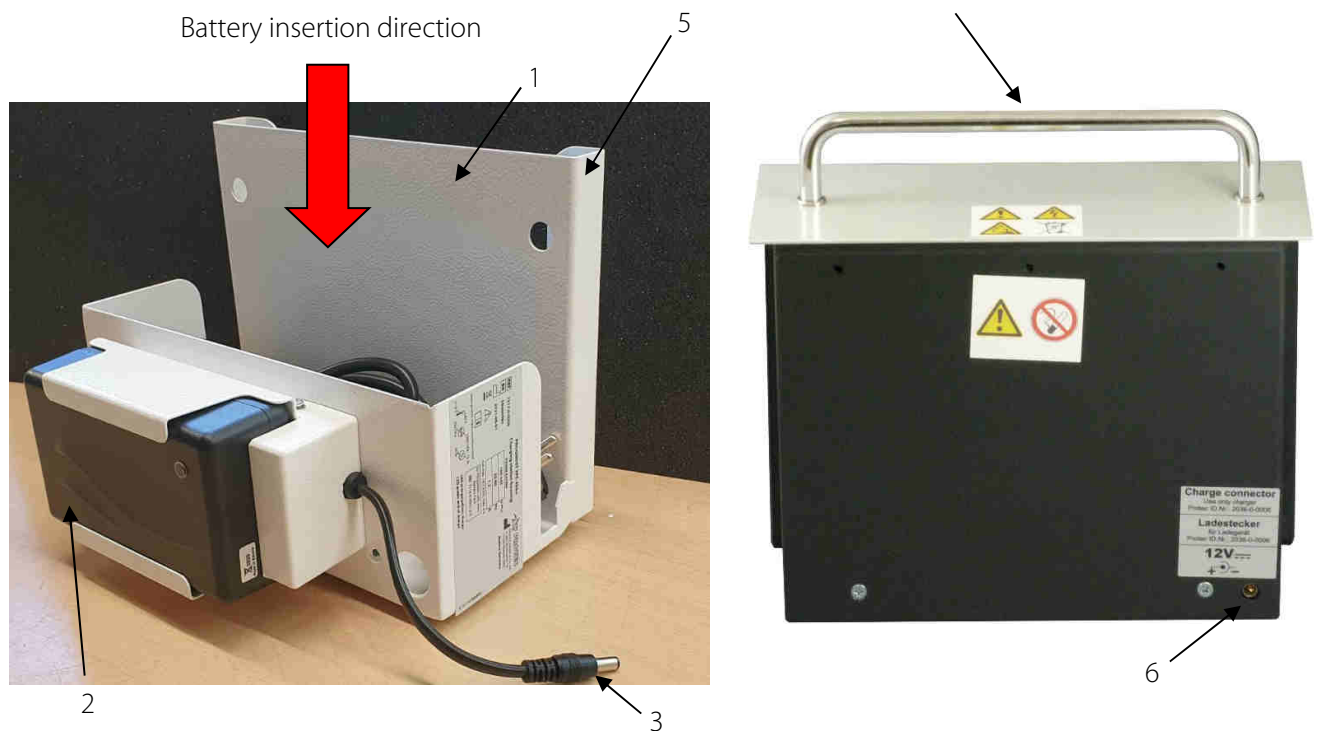

- 1 Charging station
- 2 Charger
- 3 Charging plug
- 4 Battery-Box
- 5 Wall holder
- 6 Charging socket

4.2.3.5 Charging the Battery Box

The charging station is used to store and hold the battery box to be charged. The wall holder is used for space saving wall mounting.

The battery box is not connected to the charger via the charging plug until it has been inserted into the charging station. Afterwards the charger is connected to the mains voltage.

After charging the battery box, first disconnect the charger from the mains, wait until the charging indicator lamp switches off and only at this point pull the charging plug out the charger from the battery box charging socket.

Before removing a charged battery box, the charger must be disconnected from the mains voltage and the charging plug must be removed from the battery box. Subsequent the battery box can be pulled out of the charging station.

4.2.3.6 Charging Cycle and Meaning of the Charging Control LED

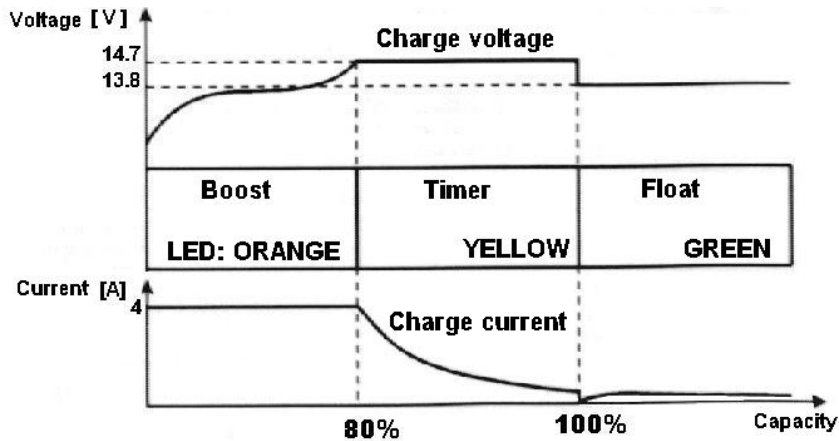

LED orange:

Fast charge mode:

The charger sets itself to constant current mode.

The charging current is constant and at maximum level until the charging voltage is reached.

Afterwards the color of the LED changes from orange to yellow, the timer is on.

LED yellow:

Timer switch mode:

The charge voltage is maintained for approx. 2 hours while the charging current decreases.

At this point the battery capacity has reached 80%-95% of the total capacity.

LED green:

Trickle charge mode (Standby):

The charger is in trickle charge mode. If the battery box remains connected to the charger after it has been charged, the charger enters the „trickle charge“ state (LED remains green) and guarantees that the charge of the battery box is maintained.



CAUTION!

To prevent an impermissibly deep discharge of the battery box, the charging plug must be removed from the charging socket of the battery box before the charger is disconnected from the mains.

4.3 Functions of the PROGNOST XP-Series

4.3.1 Switching the PROGNOST XP device on and off

All products of the PROGNOST XP-series do not have a separate on and off switch.

5 Safety and Maintenance



WARNING!

Caution, risk of electric shock!

Switch off the PROGNOST XPE or PROGNOST XPE-Akku before cleaning or disinfecting. This disconnects the respective device from the power source and avoids the risk of electric shock.

5.1 Introduction

In this chapter you will find information about safety and maintenance that are necessary to ensure the correct and reliable function of the device after installation.

5.2 Reusability

All PROGNOST XP products can be reused without any special preparation procedures.

However, it must be ensured that the surfaces in contact with patients are disinfected before the X-ray examination of each patient (see also chapter 4.1).

The PROGNOST XP device must no longer be used with patients if it shows signs of wear (e.g., metal abrasion, wear of insulations) or dangerous technical defects (e.g., torn cable, bent parts) or if the resulting image quality (e.g., artifacts in the image) is insufficient.

In this case, please contact PROTEC service department or a service company authorized by them immediately.

5.3 Cleaning and Disinfection



NOTE

Caution!

Possible material changes!



WARNING!

Make sure that no liquid enters the interior of the housing during cleaning and disinfection in order to prevent electrical short circuits and/or corrosion.

5.3.1 Cleaning

The cleaning of the PROGNOST XP-series is very easy due to the very good quality surface coating. This is usually only done with a dry cloth.

Do not use corrosive, dissolving or abrasive cleaning agents, which could damage the device surfaces or the coating.

Clean the device surfaces and painted parts with a damp cloth and a mild to slightly alkaline cleaning solution (e.g., RBS® Neutral T) and wipe dry.

Chrome parts may only be wiped with a dry woollen cloth.

5.3.2 Disinfection

The disinfection must be performed in accordance with the current applicable legal requirements and guidelines corresponding for disinfection and explosion protection.

For disinfection of surfaces in contact with patients, we recommend commercially available medical rapid disinfection wipes (e.g., Dr. Schumacher Descosept Sensitive Wipes).

All mechanical parts of the PROGNOST XP-series, including accessories, may only be cleaned with a wipe disinfection with suitable surface disinfectants (e.g., Melsept® SF, 15 min. application time at 2% concentration). The information provided by the disinfectant manufacturer on concentrations and application times must be observed.

**WARNING!**

No highly flammable disinfectants may be used! For safety reasons, spray disinfection must not be carried out, as the spray mist could penetrate the device and cause short circuits or corrosion.

If disinfectants are used that can form explosive gas mixtures, the device may only be switched on again when the gas mixtures have evaporated!

5.4 Inspection and Maintenance

**WARNING!**

No maintenance or repair work may be performed while the PROGNOST XP device is being used with a patient!

All maintenance and repair work may only be performed by personnel trained or authorized by PROTEC.

5.4.1 Daily Monitoring before and during the Examination Operation

PROGNOST XP:

- Locking of the wheels must be checked by operating the arresters
- Locking and smooth running if the table must be checked by operating the brake bracket

PROGNOST XP & PROGNOST XPE-Akku:

- Verify that the brake rollers are also braked if the arrester is in brake position
- Check that the table top brake moves smoothly if the brake bracket is applied
- Check the table top brake if the brake pedal is not actuated
- Check the height of the table top. If there is a visible difference in height, perform a zero balancing
- Perform a visual inspection of the power cable. If the power cord is damaged, stop powering the table and notify the PROTEC service department to replace the cord

5.4.2 Regular Monitoring

5.4.2.1 Quality control by the operator

Quality checks for X-ray components must be performed at regular intervals in accordance with the relevant national guidelines.

5.4.2.2 Safety-related Controls

In the interest of the patients, operators and external third parties, it is necessary that all checks regarding operational safety and/or functionality of the unit are carried out regularly every 12 months by the PROTEC customer service or a service authorized by PROTEC.

All components within the PROGNOST XP-series that may pose a risk due to wear and tear must be inspected and, if necessary, replaced every 12 months by the PROTEC service department or a PROTEC authorized service provider.

In the case that the scheduled checks are not carried out, PROTEC X-ray Systems GmbH accepts no liability for damage to the operator and third parties if and insofar as damage results from insufficient or non-performed checks.

5.4.3 Maintenance

The required maintenance must be carried out by PROTEC service department or a service company authorized by them in order to ensure the safe and reliable functionality of the device. The maintenance intervals depend on the frequency of use. The required specifications can be found in the corresponding Technical Description.

In the event that the planned maintenance is not carried out, PROTEC X-ray Systems GmbH assumes no liability whatsoever for damage to the user and third parties if damage results from inadequate or not carried out maintenance.

Prior to the examination operation, the user must satisfy himself that all appliances listed in the operating instructions and serving safety are in working order and that the product is ready for operation.

See the technical descriptions of the devices.

Wear parts must be replaced with original components.

5.4.4 Warranty



NOTE

You will find the current warranty conditions in your order documents or in the price list valid at the time of purchase.

Repairs and spare parts in the event of improper use are also excluded.

Warranty work may only be carried out by trained specialists.

5.4.5 Product Service Life

All products of the PROGNOST XP-series are designed for a service life of 10 years when used in accordance with the specifications and regular maintenance by PROTEC service department or a service company authorized by them. After the product has reached the end of its service life, further use is at your own risk.

5.4.6 Further Information

Detailed information to the individual chapters and for a safe operation, transport or storage can be found in the respective Technical Description of the PROGNOST XP-series.

5.4.7 Applied Parts and Parts Considered as Applied Parts

Part	Definition (Applied part or part that is treated like an applied part but is not defined as an applied part)
Table top	Applied part
Handle (optional, mounted at the tabletop)	Part, considered as an applied part
Mattress (optional)	Part, considered as an applied part

5.4.8 Disposal Notes



The PROGNOST XP devices contain various plastics and heavy metal. When disposing exchange and spare parts, or if necessary, the entire device, the valid rules and regulations must be observed. Please contact your contractual partner or service company or commission a company specialized in disposing the respective components.

6 Power Supply



NOTE

The PROGNOST XP does not require a power supply.

6.1 PROGNOST XPE

The power supply is a wide range power supply with an input voltage range of 90...264VAC/47...63Hz.

The table is delivered in 2 versions:

Mains voltage version for table top height adjustment see marking next to the type label:

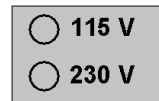

Version 1:

Mains voltage: 230V / 50Hz

Mains connection cable: 3 x 1.5mm² (16 AWG), max. length 5m

Version 2:

Mains voltage: 115V / 60Hz

Mains connection cable: 3 x 1.5mm² (16 AWG), Type SJT or better,
Max. length 5m, with "Hospital Grade" USA power plug

The power supply has the following protection functions:

- Short circuit protection: Shutdown with automatic restart
- Overload protection: 110...150%, automatic restart
- Overtemperature protection (shutdown) and overvoltage protection



WARNING!

To avoid the risk of an electric shock, this device may only be connected to a supply network with a protective earth conductor.

6.2 PROGNOST XPE-Akku

Table top height adjustment:

Power supply: 12VDC battery box

Fuse: 20A

6.3 Electromagnetic Compatibility (EMC) according to EN 60601-1-2



CAUTION!

As a medical electrical device, the PROGNOST XPE and PROGNOST XPE-Akku is subject to special precautionary measures regarding EMC and must be installed and commissioned in accordance with the EMC information contained in the accompanying documents.



CAUTION!

Portable RF communication devices (radio devices) should not be used closer than 30 cm (12 in) to the marked parts and cables of the PROGNOST XPE product. Failure to observe can lead to a reduction in the performance characteristics of the device.

6.3.1 Guidelines and Manufacturer's Declaration – Electromagnetic interference

The PROGNOST XPE and PROGNOST XPE- Akku is intended for use in the electromagnetic environment specified below. The customer or the Operator of the radiographic system should assure that it is used in such an environment.

Measurement interference	Compliance	Electromagnetic Environment
RF emissions CISPR 11	Group 1	The X-ray component uses RF energy exclusively for its internal function. As a result, its RF emissions are very low and it is unlikely that nearby electronic devices will be influenced.
RF emissions CISPR 11	Class A	The device is suitable for use in facilities other than residential areas and those that are directly connected to the public supply network, which also supplies buildings that are used for residential purposes, provided the following warning is observed: Warning: This device is intended for use by medical professionals only. This is a class A device according to CISPR 11. This device can cause radio interference in residential areas, in which case it must be necessary to take appropriate remedial measures such as new alignment, rearrangement or shielding of the device or filtering of the connection to the location.
Harmonic emissions EN 61000-3-2	Class A	
Voltage fluctuations/ flicker emissions EN 61000-3-3	compliant	

Immunity Test	EN 60601-1-2 Test Level	Compliance Level	Electromagnetic Environment - Guidance
Electrostatic discharge (ESD) EN 61000-4-2	± 8 kV contact discharge ± 2 kV, ± 4 kV, ± 8 kV, ± 15 kV air discharge	± 8 kV contact discharge ± 2 kV, ± 4 kV, ± 8 kV, ± 15 kV air discharge	Floors should be made of wood, concrete or ceramic tiles. If the floor is covered with synthetic material, the relative humidity must be at least 30%.
Fast transient electrical disturbance variables / burst EN 61000-4-4	± 2 kV for power supply lines	± 2 kV for power supply lines	The quality of the supply voltage should correspond to that of a typical business or hospital environment.

Surges EN 61000-4-5	± 0,5 kV ± 1 kV ± 2 kV	± 0,5 kV ± 1 kV ± 2 kV	The quality of the supply voltage should be that of a typical commercial or hospital environment.
Magnetic field at the supply frequency (50/60 Hz) EN 61000-4-8	30 A/m 50 Hz	30 A/m 50 Hz	Magnetic fields at the mains frequency should correspond to the typical values found in a business and hospital environment.
Voltage dips, short interruptions and fluctuations in the supply voltage EN 61000-4-11	0% U _T for 0,5 Period at 0°, 45°, 90°, 135°, 180°, 225°, 270°, and 315°	0% U _T for 0,5 Period at 0°, 45°, 90°, 135°, 180°, 225°, 270°, and 315°	The quality of the supply voltage should correspond to that of a typical business or hospital environment. If the user of the device demands continued operation even if there are interruptions in the energy supply, it is recommended that the device be fed from an uninterruptible power supply or battery.
	0% U _T for 1 Period 70% U _T for 25/30 Periods 0% U _T for 250 Periods	0% U _T for 1 Period 70% U _T for 25/30 Periods 0% U _T for 250/300 Periods	
Conducted disturbances induced by RF fields EN 61000-4-6	3 V/m 1 kHz 80% AM 150 kHz bis 80 MHz	3 V/m	
Radiated RF disturbances EN 61000-4-3	3 V/m 1kHz 80% AM 80 MHz to 2.7 GHz	3 V/m	See table below
NOTE: These guidelines may not apply in all situations. Electromagnetic propagation is affected by absorption and reflection from structure, objects and people.			

Test Frequency in MHz	Frequency Band in MHz	Service in MHz	Modulation	Immunity Testing Level in V/m
385	380 - 390	TETRA 400	Pulse modulation: 18 Hz	27
450	430 – 470	GMRS 460, FRS 480	FM ±5 kHz Deviation 1 kHz Sine	28
710 745 780	704 – 787	LTE Band 13, 17	Pulse modulation: 217 Hz	9
810 870 930	800 – 960	GSM 800/900, TETRA 800, iDEN 820, CDMA 850, LTE Band 5	Pulse modulation: 18 Hz	28
1720 1845 1970	1700 - 1990	GSM 1800, CDMA 1900, GSM 1900, DECT, LTE Band 1, 3, 4, 25, UMTS	Pulse modulation: 217 Hz	28
2450	2400 – 2570	Bluetooth, WLAN, 802.11 b/g/n, RFID 2450, LTE Band 7	Pulse modulation: 217 Hz	28
5240 5500 5785	5100 - 5800	WLAN, 802.11 a/n	Pulse modulation: 217 Hz	9

7 Technical Data

7.1 Dimensions

7.1.1 Dimensions PROGNOST XP

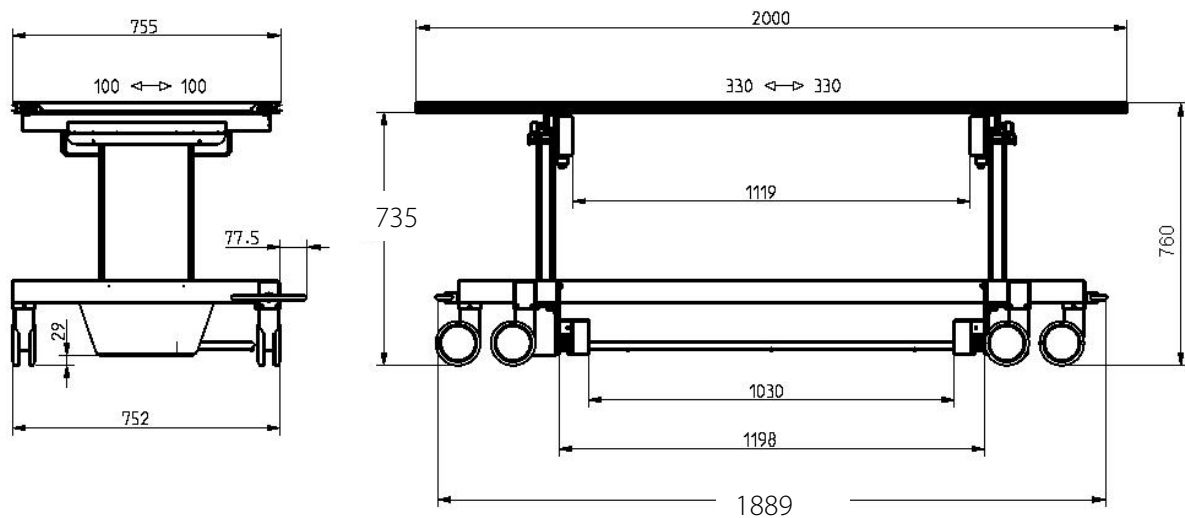

Table top dimensions:

200 cm x 75,5 cm or
226 cm x 75,5 cm or
200 cm x 65,5 cm

Max. Patient weight (distributed load):

230 kg (composite fiber table top)
250 kg (carbon fiber table top)

Total weight without patient:

103 kg

Table height:

760 mm

Table top transverse displacement (from center position):

± 100 mm

Table top longitudinal displacement (from center position):

± 330 mm (200 cm table top)

Table top longitudinal displacement (from center position):

± 460 mm (226 cm table top)

Clear opening between the columns under the table top:

1119 mm

The brakes of the table top and wheels are mechanically operated.

7.1.2 Dimensions PROGNOST XPE

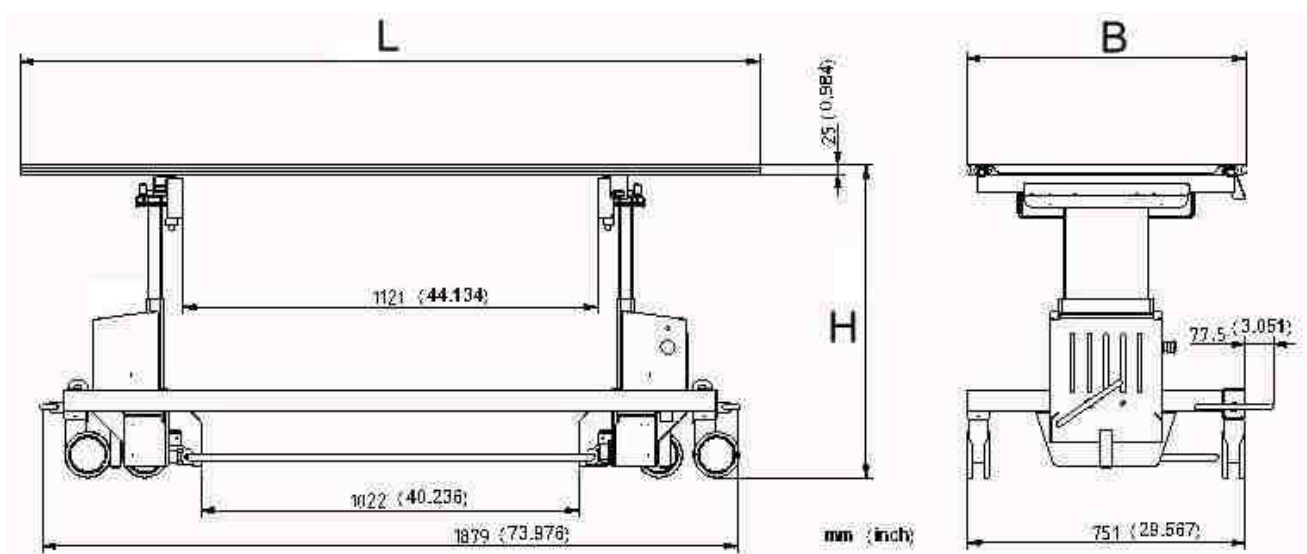

Table top dimensions:	200 cm x 75,5 cm or 226 cm x 75,5 cm or 200 cm x 65,5 cm
Max. Patient weight (distributed load):	230 kg (composite fiber table top) 250 kg (carbon fiber table top)
Total weight without patient:	114 kg
Table height displacement:	610-870 mm
Table top transverse displacement (from center position):	± 100 mm
Table top longitudinal displacement (from center position):	± 330 mm (2m table top)
Table top longitudinal displacement (from center position):	± 460 mm (2,26m table top)
Clear opening between the columns under the table top:	1121 mm

The brakes of the table top and wheels are mechanically operated.

7.1.3 Dimensions PROGNOST XPE-Akku

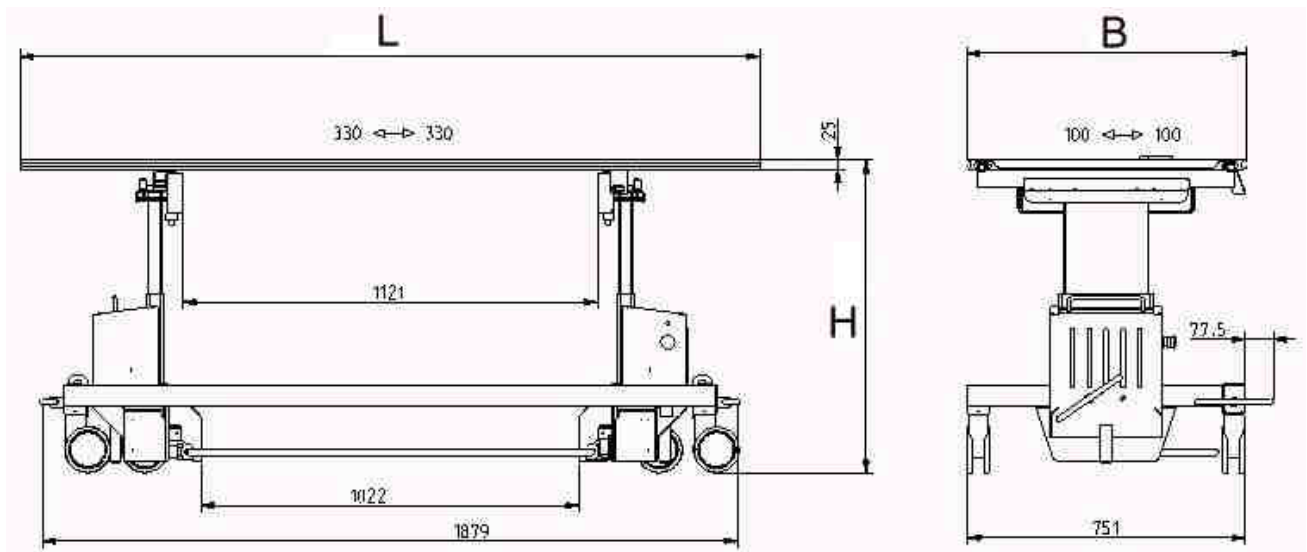

Table top dimensions:	200 cm x 75,5 cm or 226 cm x 75,5 cm or 200 cm x 65,5 cm
Max. Patient weight (distributed load):	230 kg (composite fiber table top) 250 kg (carbon fiber table top)
Total weight without patient:	129 kg
Table height displacement:	610-870 mm
Table top transverse displacement (from center position):	± 100 mm
Table top longitudinal displacement (from center position):	± 330 mm (2m table top)
Table top longitudinal displacement (from center position):	± 460 mm (2,26m table top)
Clear opening between the columns under the table top:	1121 mm

The brakes of the table top and wheels are mechanically operated.

7.2 Attenuation Equivalent



CAUTION!

The attenuation equivalent of the respective PROGNOST XP device may have to be considered during the acceptance test of the X-ray system.

The tabletop is defined as an applied part.

The aluminum attenuation equivalent of the table top is typically 0,7 and <0,8 mm Al for carbon; 0,85 mm Al for composite material according to EN 60601-1-3 at 100kV and a first half value layer thickness of 3.6 mm Al and typically 0,6 and <0,8 mm Al according to 21CFR § 1020.30 (m) at 100 kV and a first half value layer thickness of 3.6 mm Al.

7.2.1 Protection Type and Protection Class

The PROGNOST XP has no protection class, whereas the PROGNOST XPE and PROGNOST XPE-Akku corresponds to protection class 1.

All devices of the PROGNOST XP-series contain applied parts type B (according to EN 60601-1).

7.3 Environmental Conditions

7.3.1 Environmental Conditions during Operation

Ambient temperature	+ 10°C to + 40°C
Relative humidity	30% to 75% (non-condensing)
Atmospheric pressure	700 hPa to 1060 hPa



NOTE

The recommended operating temperature range for lead batteries is 10°C to 30°C. The ideal operating temperature range is 20°C ± 5°. Higher temperatures shorten the service life. Lower temperatures reduce available capacity.















Exceeding the limit temperature of 55°C (for lead batteries) is not permitted. Permanent operating temperatures greater than 40°C should be avoided.















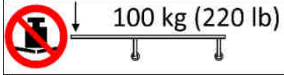

7.3.2 Environmental Conditions for Shipping and Storage

Ambient Temperature	- 10°C to + 70°C
Relative humidity	10% to 95% (non-condensing)
Atmospheric pressure	500 hPa to 1060 hPa

8 Description of Symbols, Labels and Abbreviations

8.1 Symbols

	Atmospheric pressure limit
	Temperature limit
	Humidity limit
	Keep dry
	Fragile, handle with care
	This way up
	Attention, observe accompanying documents
	Refer to Instructions for use
	CE marking
	Manufacturer
	Medical Device
	Order reference
	Serial number
	Unique Device Identification
	Production date

	Classification according to EN 60601-1 (type B applied part)
	Caution: pinch-/crushing hazard for hands and fingers
 www.protec-med.com/download	This symbol indicates the need to observe the instructions for use. This is provided in an electronic format (eIFU) on our website.
	Disposal instructions; WEEE (Waste of Electrical and Electronic Equipment)
	Protective earthing
	Do not exceed the maximum indicated weight
	Do not exceed the maximum indicated weight
	Tabletop movements for exposure
	Longitudinal movement of the tabletop
	Transverse movement of the tabletop
	Brakes of the brake rollers released
	Brakes of the brake rollers locked
	Warning High Voltage
	Warning of danger from batteries (only PROGNOST XPE-Akku)
	Do not touch contacts (only PROGNOST XPE-Akku)
	Smoking prohibited (only PROGNOST XPE-Akku)

8.2 Type Label

8.2.1 Type Label PROGNOST XP

MD	PROGNOST XP	
REF 7036-0-1710	Basic diagnostic X-ray system table, non-powered	PROTEC X-ray Systems GmbH In den Dorfwiesen 14 71720 Oberstenfeld Germany
SN SNxxxxxx		
2025-07-09		
		UDI
www.protec-med.com/download		
	CE	(01)04260502640203 (11)250709 (21)SNxxxxxx
		TL 7036-0-1710V05

8.2.2 Type Label PROGNOST XPE

MD	PROGNOST XPE											
REF 7037-1-1710	Basic diagnostic X-ray system table, powered	PROTEC X-ray Systems GmbH In den Dorfwiesen 14 71720 Oberstenfeld Germany										
SN SNxxxxxx												
2025-07-09												
		UDI 										
www.protec-med.com/download												
	<table border="1"> <tr><th colspan="2">POWER RATING</th></tr> <tr><td>230</td><td>V ~</td></tr> <tr><td>50/60</td><td>Hz</td></tr> <tr><td>1.6</td><td>A</td></tr> <tr><td>S3 15%</td><td>ED</td></tr> </table> <p>Internal modification to 115V ~ / 3.15A possible</p>	POWER RATING		230	V ~	50/60	Hz	1.6	A	S3 15%	ED	(01)04260502641798 (11)250709 (21)SNxxxxxx
POWER RATING												
230	V ~											
50/60	Hz											
1.6	A											
S3 15%	ED											
	CE	TL 7037-1-1710V04										

MD	PROGNOST XPE											
REF 7037-6-1710	Basic diagnostic X-ray system table, powered	PROTEC X-ray Systems GmbH In den Dorfwiesen 14 71720 Oberstenfeld Germany										
SN SNxxxxxx												
2025-07-09												
		UDI 										
www.protec-med.com/download												
	<table border="1"> <tr><th colspan="2">POWER RATING</th></tr> <tr><td>115</td><td>V ~</td></tr> <tr><td>50/60</td><td>Hz</td></tr> <tr><td>3.15</td><td>A</td></tr> <tr><td>S3 15%</td><td>ED</td></tr> </table> <p>Internal modification to 230 V ~ / 1.6 A possible</p>	POWER RATING		115	V ~	50/60	Hz	3.15	A	S3 15%	ED	(01)04260502640258 (11)250709 (21)SNxxxxxx
POWER RATING												
115	V ~											
50/60	Hz											
3.15	A											
S3 15%	ED											
	CE	TL 7037-6-1710V04										

8.2.3 Type Label PROGNOST XPE-Akku

MD	PROGNOST XPE-Akku													
REF 7038-9-1710	Basic diagnostic X-ray system table, powered	PROTEC X-ray Systems GmbH In den Dorfwiesen 14 71720 Oberstenfeld Germany												
SN SNxxxxxx														
2025-07-09														
		UDI 												
www.protec-med.com/download														
	<table border="1"> <tr><th colspan="2">POWER RATING</th></tr> <tr><td>12</td><td>V =</td></tr> <tr><td colspan="2">Internal battery supply</td></tr> <tr><td colspan="2">Use only PROTEC battery pack</td></tr> <tr><td colspan="2">REF 7516-0-0001</td></tr> <tr><td>S3 15%</td><td>ED</td></tr> </table>	POWER RATING		12	V =	Internal battery supply		Use only PROTEC battery pack		REF 7516-0-0001		S3 15%	ED	(01)04260502640302 (11)250709 (21)SNxxxxxx
POWER RATING														
12	V =													
Internal battery supply														
Use only PROTEC battery pack														
REF 7516-0-0001														
S3 15%	ED													
	CE	TL 7038-9-1710V04												

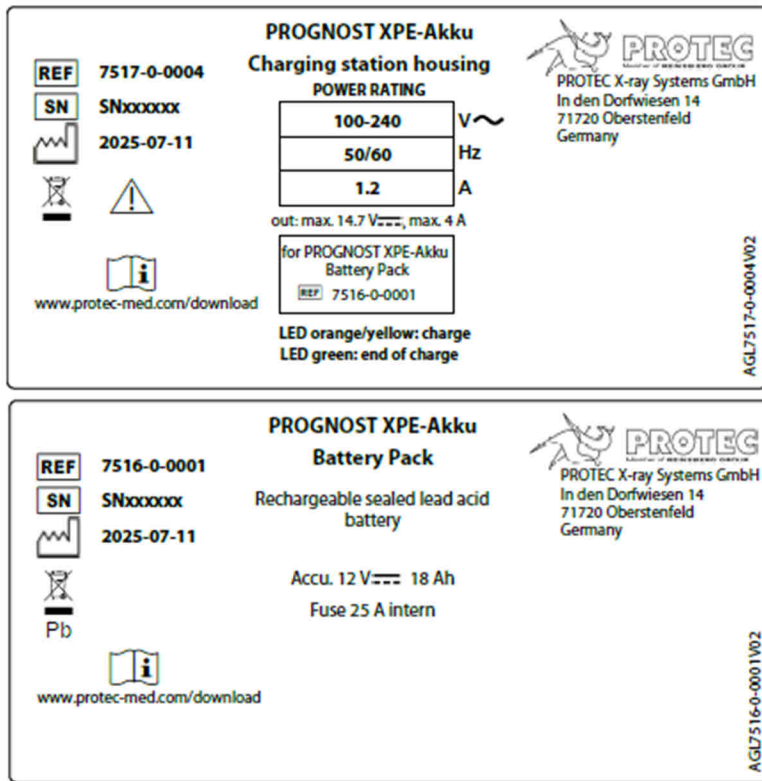

8.3 Labels

8.3.1 Labels PROGNOST XP

Labels on the front side of the different table tops

	Table top carbon fiber
	Table top composite fiber 200cm
	Table top composite fiber 226cm

Labels on the top of the table top

	Caution: Watch out for possible crushing hazards to fingers or hands while moving the tabletop, table or X-ray unit.
	Maximum allowed patient weight (distributed load) for the tabletop (Composite-fiber tabletop).
	Maximum allowed patient weight (distributed load) for the tabletop (Carbon fiber tabletop).

Labels on the lower table top frame

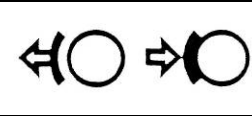

 <p>Achtung! Der Tisch ist nur zur Patientenlagerung an Röntgenarbeitsplätzen bestimmt!</p> <p>CAUTION! Table use for patient positioning in radiographic rooms only!</p>	<p>Caution: Table use for patient positioning in radiographic rooms only!</p>
	<p>Label lock / release brake rollers</p>

8.3.2 Labels PROGNOST XPE

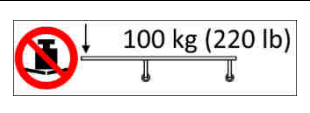
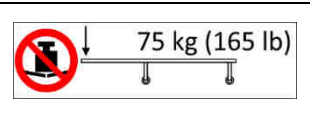
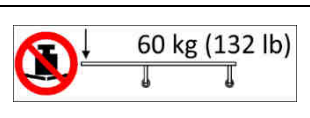
Labels on the front side of the different table tops

	<p>Table top carbon fiber</p>
	<p>Table top composite fiber 200cm</p>
	<p>Table top composite fiber 226cm</p>

Labels on the top of the table top

	<p>Caution: Watch out for possible crushing hazards to fingers or hands while moving the tabletop, table or X-ray unit.</p>
	<p>Maximum allowed patient weight (distributed load) for the tabletop (Composite-fiber tabletop).</p>
	<p>Maximum allowed patient weight (distributed load) for the tabletop (Carbon fiber tabletop).</p>

Labels on the lower table top frame

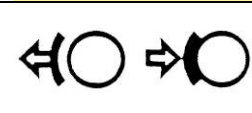
 <p>Achtung! Der Tisch ist nur zur Patientenlagerung an Röntgenarbeitsplätzen bestimmt!</p> <p>CAUTION! Table use for patient positioning in radiographic rooms only!</p>	<p>Caution: Table use for patient positioning in radiographic rooms only!</p>
	<p>Label lock / release brake rollers</p>
<p>grounding reliability can only be achieved when the EQUIPMENT is connected to an equivalent receptacle marked "Hospital Only" or "Hospital Grade"</p>	<p>Label next to the power input</p>

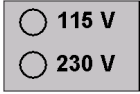

	Warning label on the lower right cover
	Power supply version

8.3.3 Labels PROGNOST XPE-Akku

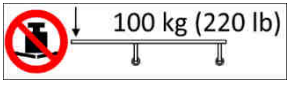
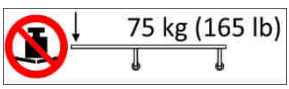
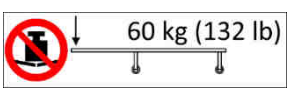

Labels on the front side of the different table tops

	Table top carbon fiber
	Table top composite fiber 200cm
	Table top composite fiber 226cm

Labels on the top of the table top





	Caution: Watch out for possible crushing hazards to fingers or hands while moving the tabletop, table or X-ray unit.
	Maximum allowed patient weight (distributed load) for the tabletop (Composite-fiber tabletop).
	Maximum allowed patient weight (distributed load) for the tabletop (Carbon fiber tabletop).

Labels on the lower table top frame

	Caution: Table use for patient positioning in radiographic rooms only!
	Label lock / release brake rollers

Labels for the battery

	Warning label on the battery box cover plate
-------------------------------------------------------------------------------------	----------------------------------------------

	<p>Warning label on the side of the battery box</p>
<p>Charge connector Use only charger Protec ID.Nr.: 2036-0-0006</p> <p>Ladestecker für Ladegerät Protec ID.Nr.: 2036-0-0006</p> <p>12V </p> <p></p>	<p>Label on the battery box</p>
<p>Use UL listed types only Autofuse rated 32dc</p> <p>FUSE 20A Sicherung</p>	<p>Label inside of the supply station</p>
	<p>Label for the positive pole of the 12VDC battery supply inside the supply station and on the battery box</p>
	<p>Label for the negative pole of the 12VDC battery supply inside the supply station and on the battery box</p>

8.4 Positions of the Signs and Labels

8.4.1 Positions of the Signs and Labels PROGNOST XP

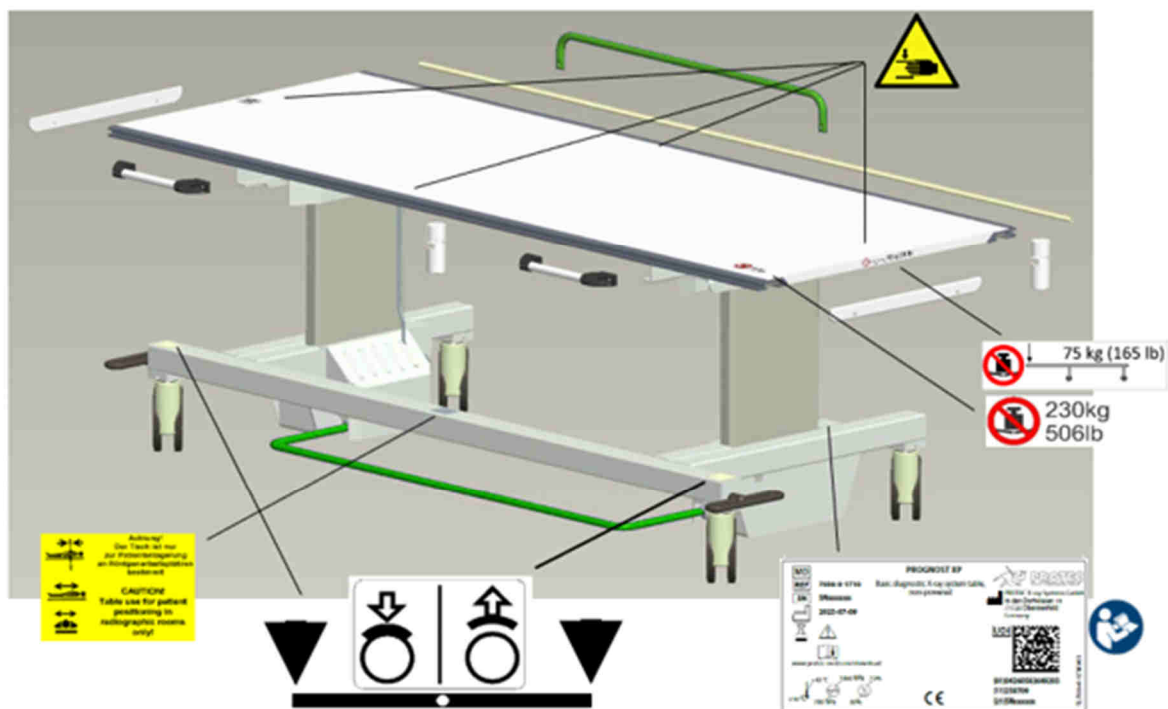

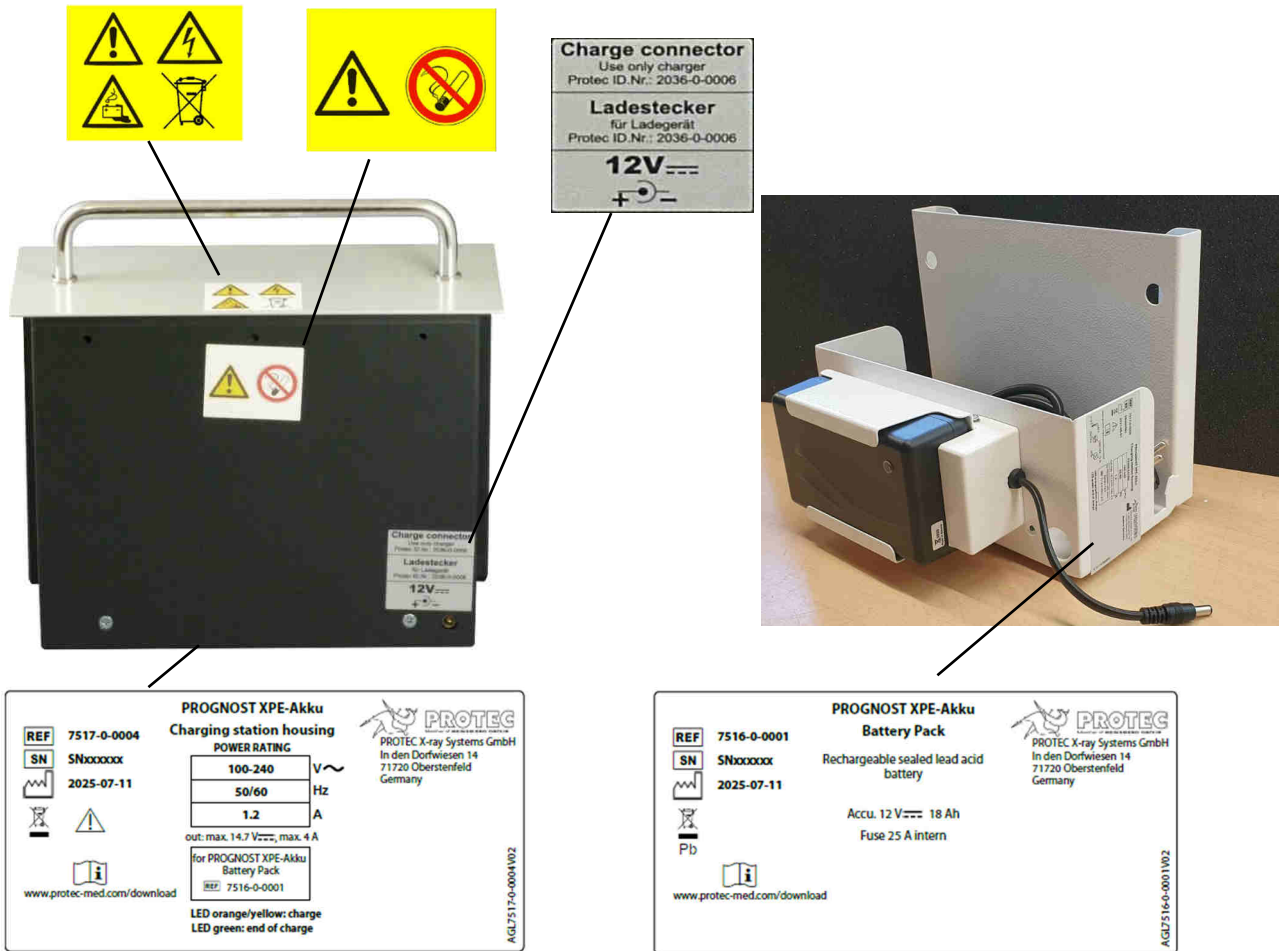

8.5 Abbreviations

Mm	Millimetres
cm	Centimetres
lb.	Pound
Kg	Kilogram
°C	Degree - Celsius
hPa	Hectopascal
DIN	German Industry Standard
EN	European Standard
CE	CE marking
Hz	Hertz
ED	Duty Cycle
A	Ampere
SN	Serial number