

# PROVERT

## Diagnostic X-ray system image receptor floor stand

**Model/ID: 7401-5-8xxx**  
Basic UDI-DI: 426050264X017ZS

### Instructions for use

ID. No. 5401-0-8002



**CE**

**NOTE**

All sheets of this document contain proprietary and confidential information of PROTEC X-ray Systems GmbH and is intended for exclusive use by current PROTEC X-ray Systems GmbH customers. Copying, disclosure to others or other use is prohibited without the express written consent of PROTEC's law department. Knowledge of violations of these regulations must be reported immediately to PROTEC X-ray Systems GmbH.

---

© 2025 PROTEC X-ray Systems GmbH, Oberstenfeld

Comments and questions about the documentation, please contact:

**PROTEC X-ray Systems GmbH**

In den Dorfwiesen 14 | 71720 Oberstenfeld  
Germany

Phone: (+ 49) 7062 – 92 55 0

Fax: (+ 49) 7062 – 92 55 60

E-Mail: [protec@protec-med.com](mailto:protec@protec-med.com)

Internet: [www.protec-med.com](http://www.protec-med.com)

## Table of contents

	Page
<b>Table of contents</b> .....	<b>3</b>
<b>Revision Status</b> .....	<b>5</b>
<b>General Notes</b> .....	<b>6</b>
<b>Mechanical and Electric Warning</b> .....	<b>6</b>
<b>To the User</b> .....	<b>6</b>
<b>1 Device description</b> .....	<b>7</b>
1.1 Introduction .....	7
1.2 Description.....	7
1.2.1 Versions .....	7
1.2.2 Hardware and Network System Requirements .....	7
1.2.3 Installation .....	7
1.2.3.1 Floor capacity .....	8
1.3 Product specific characteristic .....	8
1.3.1 Image receptor floor stand.....	8
1.4 Intended Use .....	8
1.5 Clinical Benefit .....	8
1.6 Patient Target Group(s).....	8
1.7 Medical Conditions to be diagnosed .....	8
1.8 Indications and Contraindications .....	8
1.9 Intended User Group.....	9
1.10 Declaration of Conformity.....	9
<b>2 Safety Instructions</b> .....	<b>10</b>
2.1 General Safety Instructions.....	11
2.1.1 Requirements for operation .....	11
2.1.2 Device Operation .....	11
2.1.2.1 Operating Type .....	11
2.1.3 Operating Personnel .....	11
2.1.4 Crushing and Collision Hazard .....	11
2.1.5 Explosion Protection .....	11
2.1.6 Interaction with Other Devices.....	11
2.1.7 Electromagnetic Environment and Influencing of Devices .....	12
<b>3 Control Elements and Displays</b> .....	<b>13</b>
3.1 Main Switch of the PROVERT .....	13
3.2 Emergency Stop Switches of the PROVERT .....	13
3.3 Control Elements and Display of PROVERT.....	13
<b>4 Handling</b> .....	<b>14</b>
4.1 Requirements before and during Operation.....	14
4.2 Operation of the PROVERT .....	14
4.2.1 Patient extending handle (optional) .....	14
4.2.2 Compression Band (optional).....	15
4.3 Function of the PROVERT.....	17
4.3.1 Switching the PROVERT on and off.....	17
<b>5 Safety and Maintenance</b> .....	<b>18</b>
5.1 Introduction .....	18
5.2 Reusability .....	18
5.3 Cleaning and Disinfection .....	18
5.3.1 Cleaning.....	18
5.3.2 Disinfection .....	18
5.4 Inspection and Maintenance.....	19
5.4.1 Daily Monitoring before and during the Examination Operation.....	19
5.4.2 Regular Monitoring .....	19
5.4.2.1 Quality control by the operator .....	19

5.4.2.2	Safety-related controls.....	19
5.4.3	Maintenance .....	19
5.4.4	Warranty.....	20
5.4.5	Product Service Life .....	20
5.4.6	Further Information .....	20
5.4.7	Applied Parts and Parts Considered as Applied Parts.....	20
5.4.8	Disposal Notes .....	20
<b>6</b>	<b>Power Supply .....</b>	<b>21</b>
6.1	Electromagnetic Compatibility (EMC) according to EN 60601-1-2 .....	21
6.1.1	Guidelines and Manufacturer's Declaration – Electromagnetic interference.....	21
<b>7</b>	<b>Technical Data.....</b>	<b>24</b>
7.1	Dimensions.....	24
7.2	Attenuation Equivalent.....	25
7.2.1	Protection Type and Protection Class .....	25
7.3	Environmental Conditions .....	25
7.3.1	Environmental Conditions during Operation.....	25
7.3.2	Environmental Conditions for Shipping and Storage .....	25
<b>8</b>	<b>Description of Symbols, Labels and Abbreviations .....</b>	<b>26</b>
8.1	Symbols .....	26
8.2	Type Label .....	27
8.3	Labels .....	27
8.4	Positions of the Signs and Labels.....	28
8.5	Abbreviations.....	28

**NOTE**

The information contained in this document conforms to the configuration of the equipment as of the date of manufacture. Revisions to the equipment subsequent to the date of manufacture will be addressed in service updates distributed to the PROTEC Technical Service Organisation.

**Revision Status**

Revision	Date	Updated pages	Comments	Author
1.0	2019-05-14	all	Newly created. Replace document 5401-0-0002_Rev07	
2.0	2019-08-07	Page 8, 26 chap. 1 chap. 6.1.1 chap. 8.1 chap. 8.2	Changed weight Intended use and GMDN terms actualized revised EMC tables removed Symbols added Identification label updated	
3.0	2020-08-11	Chap. 5.3.3	Maintenance updated	
4.0	2020-11-24	Front page	Model ID revised	
5.0	2021-05-26	all	V4.0 transferred to new layout (MDR)	MB
6.0	2022-12-07	Chap. 1.2.1	Optional accessories correcte	ML
7.0	2024-12-03	Chap. 7.1	Vertical shift film centre changed	ML
8.0	2025-07-15	All	First edition PROTEC X-ray Systems GmbH	ML

## General Notes

---



### WARNING!

**In order to maintain the set and tested requirements of the 60601 series of standards, the ME system must not be modified during its actual operating life.**

---

## Mechanical and Electric Warning

---



### WARNING!

**All of the movable assemblies and parts of this equipment should be operated with care and routinely inspected in accordance with the manufacturer's recommendations contained in the equipment accompanying documents. Maintenance and service is only to be performed by customers authorized by PROTEC X-ray Systems GmbH.**

**Live electrical terminals are deadly.**

**Do not remove flexible high-tension cables from X-ray tube cover or high-tension generator and/or access covers from X-ray generator.**

**For all components of the equipment protective earthing means must be provided in compliance with the national regulations.**

**Failure to comply with the foregoing may result in serious or fatal bodily injuries to the operator or those in the area.**

---

## To the User

---



### NOTE

The user of these accompanying documents is required to carefully read through and carefully consider the instructions, warnings and cautions contained therein before starting operation.

Even if you have already operated similar systems, changes in the design, production and functional routine of the system described here may have been made, which have a significant influence on the operation.

Assembly and service works on the system described here must be carried out by authorised and qualified personnel from PROTEC X-ray Systems GmbH. Assembly personnel and other persons who are not employees of the technical service department of PROTEC X-ray Systems GmbH are requested to contact the local branch of PROTEC X-ray Systems GmbH before assembly or service work is started. For assembly and service works, it is necessary to use the "Technical Description" of the product and to observe the points it contains.

---



### NOTE

The use of the product with add-on or accessory parts not authorized by PROTEC or other unapproved components is not permitted.

---



### NOTE

According to Regulation (EU) 2017/745 of medical devices, all serious incidents related to the device must be reported to the manufacturer and the responsible authority of the Member State where the user and/or the patient is established.

---

# 1 Device description

## 1.1 Introduction

The instructions for use describe the performance characteristics and operation required for efficient and effective use of the PROVERT.

Before you work with the PROVERT, the complete instructions for use must be read, especially the Safety Instructions and the chapter Handling.

## 1.2 Description

The PROVERT has a weight balanced Bucky holder that permits easy and precise positioning and smooth movement. The adjusted position is securely fixed by an electric brake.

The diagnostic X-ray system image receptor stand is designed for vertical exposure technique of standing and seated patients.

### 1.2.1 Versions

X-ray system image receptor stand without Bucky left load	7401-0-8110
X-ray system image receptor stand without Bucky right load	7401-0-8111

### Optional Components

- X-ray cassette holder (Bucky or Grid entity)
- Measuring chamber (ionization or solid state)
- Anti-scatter grid
- DE2 (Bucky for special panes without grid)

### Optional Accessories

- Patient extending handle\*
- Compression band
- Adaption for compression band PROVERT
- Extension wall mounting
- Free-standing base plate
- Base plate big, with wall mounting

\*Accessories with medical purpose

### Accessories that can influence the EMC conditions

- Network cable ((take note of the max. cable length in the system documents))

### 1.2.2 Hardware and Network System Requirements

As a stand-alone product, the PROVERT has no hardware or network connection and therefore no hardware or network requirements.

### 1.2.3 Installation



#### NOTE

The installation of the PROVERT must be performed by PROTEC service department or a service company authorized by them.

---

For more information, please see separate "Installation manual PROVERT".

Contact information of persons qualified to perform installations are available upon request at:

**PROTEC X-ray Systems GmbH**  
In den Dorfwiesen 14 | 71720 Oberstenfeld  
Germany  
Phone: (+ 49) 7062 – 92 55 0  
Fax: (+ 49) 7062 – 92 55 60  
E-Mail: [protec@protec-med.com](mailto:protec@protec-med.com)  
Internet: [www.protec-med.com](http://www.protec-med.com)

### 1.2.3.1 Floor capacity

---



#### NOTE

The PROVERT is primarily made of metal pieces. This has a corresponding effect in the weight of the device.

The PROVERT has a weight of 168kg (without Bucky).

Every technician is obliged to check the floor load. Raised floors and hollow floors must also be considered.

---

## 1.3 Product specific characteristic

### 1.3.1 Image receptor floor stand

- Cassette sizes from 13 x 18 cm (5" x 7") to 43 x 43 cm (17" x 17")
- Suitable for digital Bucky
- Space saving with minimal footprint
- Wall-floor mounting or only floor mounting
- Cassette loading from the left or right side

### 1.4 Intended Use

The PROVERT image receptor stand is intended to be used as an electrically operated component of a diagnostic X-ray system to mount, support and facilitate positioning of an X-ray cassette holder (not included) for various routine applications in planar X-ray imaging in human medicine.

### 1.5 Clinical Benefit

Considered in isolation, no clinical benefit can be shown for image receptor floor stands.

As components of diagnostic X-ray systems in human medicine, they contribute to the clinical benefit of X-ray systems, which consists of the generation of conventional two-dimensional X-ray images for creation or specification of findings as a basis for treatment decisions.

### 1.6 Patient Target Group(s)

The intended patient group includes all people for whom a justifying indication for a medical X-ray has been given by a physician with the necessary expertise in radiation protection.

There are no general or fundamental restrictions on the patient group regarding age, gender, origin and patient condition.

### 1.7 Medical Conditions to be diagnosed

As standalone products, image receptor floor stands, have no function to diagnose, treat and/or monitor medical conditions.

### 1.8 Indications and Contraindications

As standalone products, image receptor floor stands have no intended main effect in or at the human body. Therefore, considered in isolation, no indications or contraindications can be shown for them.

## 1.9 Intended User Group

As a component of a diagnostic X-ray system, PROVERT is intended exclusively for use by professional users who are trained in the operation of diagnostic X-ray systems in accordance with the respective national regulations and who are familiar with the proper handling, use and operation and also have been instructed in the permitted conjunction with other medical products, objects and accessories. Appropriate users can be, for example: X-ray technicians, X-ray assistants, medical technical X-ray assistants, surgeons, casualty surgeons, orthopaedists and other trained medical personnel.

## 1.10 Declaration of Conformity



This product complies with the requirements of Regulation (EU) 2017/745 of the European Parliament and of the Council of 5 April 2017 on medical devices, including all applicable corrigenda.

The declaration of conformity is available upon request from PROTEC:

### **PROTEC X-ray Systems GmbH**

In den Dorfwiesen 14 | 71720 Oberstenfeld  
Germany

Phone: (+ 49) 7062 – 92 55 0

Fax: (+ 49) 7062 – 92 55 60

E-Mail: [protec@protec-med.com](mailto:protec@protec-med.com)

Internet: [www.protec-med.com](http://www.protec-med.com)

## 2 Safety Instructions



### NOTE

Contains information that must be observed during operation.

xxx



### CAUTION!

Contains information which, if not observed, can cause property damage.

xxx



### WARNING!

Contains information which, if not followed, can cause personal injury.

xxx



### WARNING!

Warning of radioactive substances or ionizing radiation. Contains information which, if not observed, can cause personal injury.

xxx

Settings and calibrations that are not described in these instructions for use must be carried out using the technical description of the device by PROTEC service department or a service company authorized by them.



### NOTE

All instructions supplied with the PROVERT must be observed and the safety instructions contained therein must be carefully read and adhered to.



### NOTE

After the initial installation, the commissioning must be recorded with the PROTEC acceptance protocol FB-04-07A4.



### NOTE

The PROVERT may only be commissioned if all safety measures for operator protection have been met and checked. These protective measures can include door contact, designated area, dosimeter, protective clothing, etc.



### CAUTION!

**The instructions for use contain all the information relevant to safety in order to generally put the PROVERT into operation. The device may only be operated by appropriately trained and trained personnel. In this context, operation is ensured by clear symbols on the control elements. All further information and instructions can be found on the supplied data carrier (USB, CD or DVD). This information applies in its entirety as an appendix to these instructions for use and must be observed.**



### NOTE

All control elements are described again in detail in these operating instructions.

## 2.1 General Safety Instructions

### 2.1.1 Requirements for operation

---



#### **WARNING!**

The PROVERT is a protection class I device (according to EN 60601-1). To avoid the risk of an electric shock, this device may only be connected to a supply network with a protective earthing conductor. The power supply for the PROVERT of the X-ray system is exclusively made by direct connection to the X-ray generator or the Power Box and is permanently connected there. The X-ray generator or the Power Box must have at least 2 connections for 230V 50/60Hz. The X-ray generator of the X-ray system is connected to the supply network (see technical description of the X-ray generator). To reduce the risk of electric shock, the system must be connected to a supply network with protective earthing. The system does not have an on/off switch. It is switched on or off directly by switching on the X-ray generator or by the switch on the Power Box. In order to separate any electrical voltage from the X-ray system, the connected X-ray generator or the Power Box must be switched off.

---

### 2.1.2 Device Operation

In case of a malfunction, do not use the PROVERT anymore and notify PROTEC service department or a service company authorized by them.

#### 2.1.2.1 Operating Type

The PROVERT is not intended for continuous operation.

### 2.1.3 Operating Personnel

---



#### **NOTE**

Only trained and authorized personnel are allowed to work on the PROVERT.

---



#### **NOTE**

The operating personnel must be familiar with all warning signs attached to the PROVERT. They are used for your own safety and that of others and ensure proper operation.

---

### 2.1.4 Crushing and Collision Hazard

---



#### **WARNING!**

It must be ensured that when operating the moving parts of PROVERT, no persons or objects are in the obvious danger area of the device. If not observed, it can result in personal injury or damage to the PROVERT or other objects.

---

### 2.1.5 Explosion Protection

The PROVERT is not designated for use within areas with explosive hazards.

### 2.1.6 Interaction with Other Devices

Interactions with other devices are not known.

---

### 2.1.7 Electromagnetic Environment and Influencing of Devices

---

**CAUTION!**

**The use of other accessories, other converters and other cables than those specified by PROTEC or provided in the documentation of the component manufacturer can result in increased electromagnetic interference or reduced electromagnetic immunity of the device and lead to defective operation.**

---

**CAUTION!**

**The use of the PROVERT immediately next to other devices or with other devices in a stacked form should be avoided, as this could result in defective operation. If use in the manner described above is nevertheless necessary, the PROVERT and the other devices should be observed to ensure that they are working properly.**

---

**NOTE**

The properties of this device, determined by emissions, allow its use in industrial areas and in hospitals (CISPR 11, class A). When used in residential areas (for which class B is usually required by CISPR 11), this device may not provide adequate protection for radio services. The user may need to take remedial measures such as relocating or realigning the device.

---

The PROVERT is intended for use in an environment in professional health care facilities (e.g., clinics, surgery centres, physiology practices ...).

### 3 Control Elements and Displays

#### 3.1 Main Switch of the PROVERT

The PROVERT does not have a main switch.

#### 3.2 Emergency Stop Switches of the PROVERT

The PROVERT does not have an emergency stop switch.

#### 3.3 Control Elements and Display of PROVERT

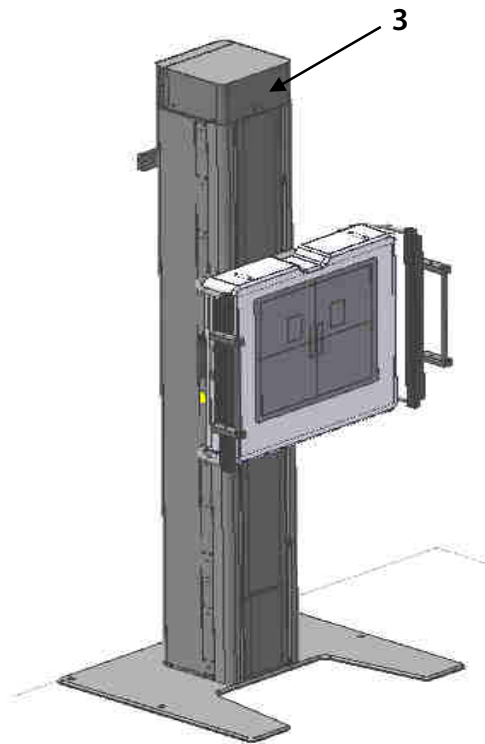
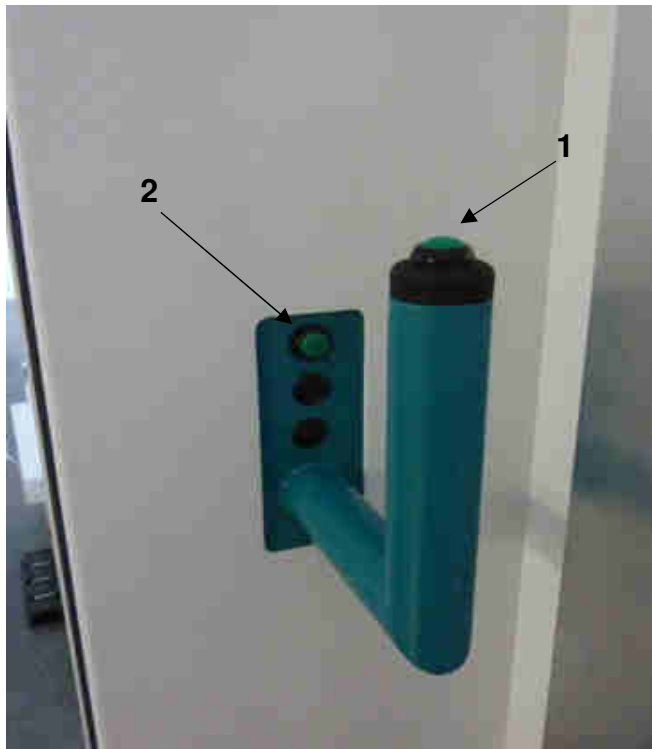

**1** "Brake release" button for the vertical movement of the Bucky

**2** "On switch collimator light" button (this function can only be realized in connection with the X-ray system tube support, floor stand PROGNOT SH)

**3** Rope breakage indicator

## 4 Handling

### 4.1 Requirements before and during Operation

It must be ensured that the surfaces in contact with patients are disinfected before the X-ray examination of each patient (see chapter 5.3.2).

### 4.2 Operation of the PROVERT

Pressing the “brake release” button (see chapter 3.3) on the handle releases the lock and the carriage can be moved.

Pressing the button on the back of the Bucky holder (see chapter 3.3) switches on the light of the collimator on the X-ray tube support, floor stand (PROGNOST SH).

#### 4.2.1 Patient extending handle (optional)

The patient extending handle (1) is inserted into the handle holder from above. By lifting it slightly, the extending handle is pulled out of the square guide and can be turned 90° to the left or right side. By lowering, turning is not possible anymore.

In the application, the patient extending handle is turned forward by 90°.

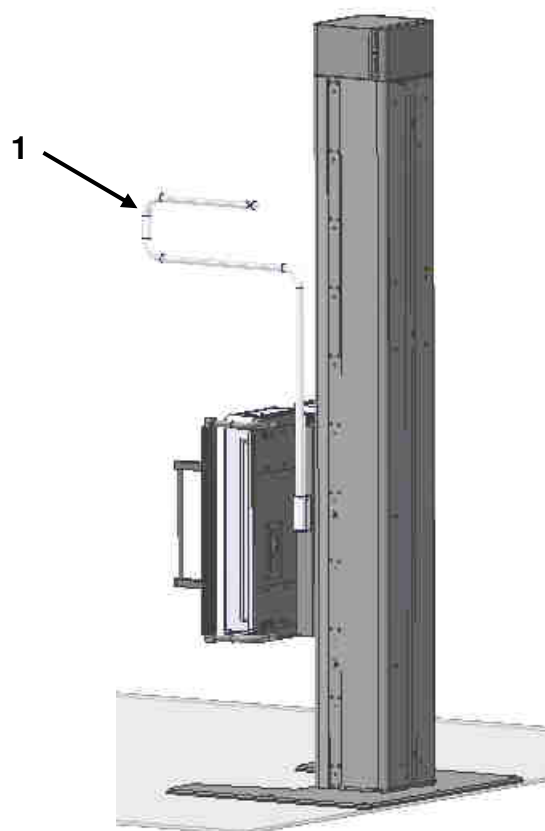

## 4.2.2 Compression Band (optional)

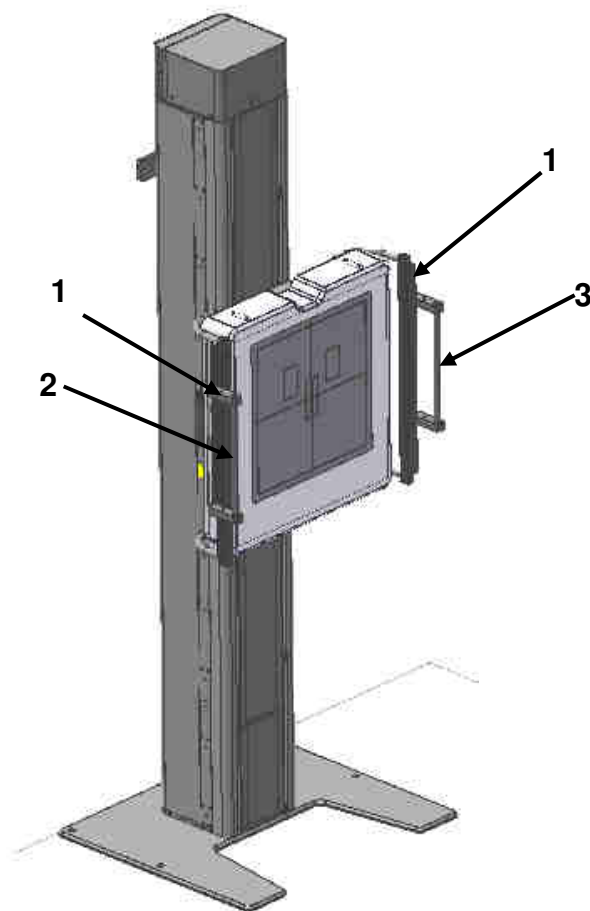

- 1 Rails with holder (adaption compression band)
- 2 Carriage with fixed roller
- 3 Rotating roller with locking device

### Installation of the compression band:

Step 1: Insert the stretching roller with locking device into the right support rail and fix it with the click wheel.



Step 2: Insert the fixed stretching roller into the support rail on the left side and fix it at the same height as the roller on the right rail. Insert the compression band and pull it around the stretching roller.



Step 3: Apply the compression band around the patient at the height of the reception area and insert it at the rotating stretching roller.



Step 4: Hold the band and turn the hand wheel to fasten the compression band.



Step 5: To release the compression band, turn the hand wheel further and rotate the locking level forwards. Unscrew the hand wheel and remove the compression band in reversed order.



### **4.3 Function of the PROVERT**

#### **4.3.1 Switching the PROVERT on and off**

The PROVERT starts with applying of a power supply and is not started separately.

## 5 Safety and Maintenance

---



### WARNING!

**Caution, risk of electric shock!**

**Switch off the PROVERT before cleaning or disinfecting. This disconnects the PROVERT from the power source and avoids the risk of electric shock.**

---

### 5.1 Introduction

In this chapter you will find information about safety and maintenance that are necessary to ensure the correct and reliable function of the device after installation.

### 5.2 Reusability

The PROVERT can be reused without any special preparation procedures.

However, it must be ensured that the surfaces in contact with patients are disinfected before the X-ray examination of each patient (see also chapter 4.1).

The PROVERT must no longer be used with patients if it shows signs of wear (e.g., metal abrasion, wear of insulations) or dangerous technical defects (e.g., torn cable, bent parts) or if the resulting image quality (e.g., artifacts in the image) is insufficient.

In this case, please contact PROTEC service department or a service company authorized by them immediately.

### 5.3 Cleaning and Disinfection

---



#### NOTE

Caution!

Possible material changes!

---



#### WARNING!

**Make sure that no liquid enters the interior of the housing during cleaning and disinfection in order to prevent electrical short circuits and/or corrosion.**

---

#### 5.3.1 Cleaning

The cleaning of the PROVERT is very easy due to the very good quality surface coating. This is usually only done with a dry cloth.

Do not use corrosive, dissolving or abrasive cleaning agents, which could damage the device surfaces or the coating.

Clean the device surfaces and painted parts with a damp cloth and a mild to slightly alkaline cleaning solution (e.g., RBS® Neutral T) and wipe dry.

Chrome parts may only be wiped with a dry woollen cloth.

#### 5.3.2 Disinfection

The disinfection must be performed in accordance with the current applicable legal requirements and guidelines corresponding for disinfection and explosion protection.

For disinfection of surfaces in contact with patients, we recommend commercially available medical rapid disinfection wipes (e.g., Dr. Schumacher Descosept Sensitive Wipes).

All mechanical parts of the PROVERT, including accessories, may only be cleaned with a wipe disinfection with suitable surface disinfectants (e.g., Melsept® SF, 15 min. application time at 2% concentration). The information provided by the disinfectant manufacturer on concentrations and application times must be observed.

**WARNING!**

**No highly flammable disinfectants may be used! For safety reasons, spray disinfection must not be carried out, as the spray mist could penetrate the device and cause short circuits or corrosion.**

**If disinfectants are used that can form explosive gas mixtures, the device may only be switched on again when the gas mixtures have evaporated!**

---

## 5.4 Inspection and Maintenance

---

**WARNING!**

**No maintenance or repair work may be performed while the PROVERT is being used with a patient!**

**All maintenance and repair work may only be performed by personnel trained or authorized by PROTEC.**

---

### 5.4.1 Daily Monitoring before and during the Examination Operation

Prior to operation, the operator must ensure that all safety related mechanisms, indicators and/or switches described within the user manual are fully functional and that the device is overall operationally ready.

### 5.4.2 Regular Monitoring

#### 5.4.2.1 Quality control by the operator

Quality checks for X-ray components must be performed at regular intervals in accordance with the relevant national guidelines.

#### 5.4.2.2 Safety-related controls

In the interest of the patient, operator and external third parties, it is necessary that all checks regarding operational safety and/or functionality of the device are performed regularly every 12 months by the PROTEC customer service department, or a service provider authorized by PROTEC.

All components within the PROVERT, which may pose a risk due to wear and tear must be inspected and, if necessary, replaced every 12 Months by the PROTEC service department or a PROTEC authorized service provider.

In the case that the intended safety-related checks are not carried out, PROTEC X-ray Systems GmbH accepts no liability for damage to the operator and third parties if and insofar as damage results from insufficient or non-performed checks.

### 5.4.3 Maintenance

The required maintenance must be carried out by PROTEC service department or a service company authorized by them in order to ensure the safe and reliable functionality of the device. The maintenance intervals depend on the frequency of use. The required specifications can be found in the corresponding Technical Description in chapter 3 *Maintenance and Safety Inspection*.

In the event that the planned maintenance is not carried out, PROTEC X-ray Systems GmbH assumes no liability whatsoever for damage to the user and third parties if damage results from inadequate or not carried out maintenance.

Prior to the examination operation, the user must satisfy himself that all appliances listed in the operating instructions and serving safety are in working order and that the product is ready for operation.

See the technical descriptions of the device.

Wear parts must be replaced with original components.

#### 5.4.4 Warranty



##### NOTE

You will find the current warranty conditions in your order documents or in the price list valid at the time of purchase.

Repairs and spare parts in the event of improper use are also excluded.  
Warranty work may only be carried out by trained specialists.

#### 5.4.5 Product Service Life

The PROVERT is designed for a service life of 10 years when used in accordance with the specifications and regular maintenance by PROTEC service department or a service company authorized by them. After the product has reached the end of its service life, further use is at your own risk.

#### 5.4.6 Further Information

Detailed information to the individual chapters and for a safe operation, transport or storage can be found in the Technical Description of the PROVERT.

#### 5.4.7 Applied Parts and Parts Considered as Applied Parts

Part	Definition
Bucky cover image receptor stand	Applied part or part that is treated like an applied part but is not defined as an applied part.
Patient extending handle (optional, mounted at the image receptor stand)	Applied part
Patient extending handle (optional, mounted at the image receptor stand)	Part, considered as an applied part

#### 5.4.8 Disposal Notes



The PROVERT contains various plastics and heavy metal. When disposing exchange and spare parts, or if necessary, the entire device, the valid rules and regulations must be observed. Please contact your contractual partner or service company or commission a company specialized in disposing the respective components.

## 6 Power Supply



### NOTE

The PROVERT requires the following power supply:

Power supply: 24 VDC  
Input current: 10 A

The power supply for the electromagnetic brakes of the image receptor stand is provided by a power supply with a power of 500W. This is mounted on the image receptor stand. The power supply is connected directly to the generator with 230V; 6A 2,5A; and supplies 24Vdc, 20.83A.



### WARNING!

**To avoid the risk of an electric shock, this device may only be connected to a supply network with a protective earth conductor.**

### 6.1 Electromagnetic Compatibility (EMC) according to EN 60601-1-2



### CAUTION!

**As a medical electrical device, the PROVERT is subject to special precautionary measures regarding EMC and must be installed and commissioned in accordance with the EMC information contained in the accompanying documents.**



### CAUTION!

**Portable RF communication devices (radio devices) should not be used closer than 30 cm (12 in) to the marked parts and cables of the PROVERT. Failure to observe can lead to a reduction in the performance characteristics of the device.**

#### 6.1.1 Guidelines and Manufacturer's Declaration – Electromagnetic interference

The PROVERT is intended for use in the electromagnetic environment specified below. The customer or the operator of the radiographic system should assure that it is used in such an environment.

Measurement interference	Compliance	Electromagnetic Environment
RF emissions CISPR 11	Group 1	The X-ray component uses RF energy exclusively for its internal function. As a result, its RF emissions are very low and it is unlikely that nearby electronic devices will be influenced.  The device is suitable for use in facilities other than residential areas and those that are directly connected to the public supply network, which also supplies buildings that are used for residential purposes, provided the following warning is observed:
RF emissions CISPR 11	Class A	
Harmonic emissions EN 61000-3-2	Class A	
Voltage fluctuations/ flicker emissions EN 61000-3-3	compliant	

		<b>Warning:</b> This device is intended for use by medical professionals only. This is a class A device according to CISPR 11. This device can cause radio interference in residential areas, in which case it must be necessary to take appropriate remedial measures such as new alignment, rearrangement or shielding of the device or filtering of the connection to the location.
--	--	--

Immunity Test	EN 60601-1-2 Test Level	Compliance Level	Electromagnetic Environment - Guidance
Electrostatic discharge (ESD) EN 61000-4-2	± 8 kV contact discharge ± 2 kV, ± 4 kV, ± 8 kV, ± 15 kV air discharge	± 8 kV contact discharge ± 2 kV, ± 4 kV, ± 8 kV, ± 15 kV air discharge	Floors should be made of wood, concrete or ceramic tiles. If the floor is covered with synthetic material, the relative humidity must be at least 30%.
Fast transient electrical disturbance variables / burst EN 61000-4-4	± 2 kV for power supply lines ± 1 kV for input/output lines	± 2 kV for power supply lines ± 1 kV for input/output lines	The quality of the supply voltage should correspond to that of a typical business or hospital environment.
Surges EN 61000-4-5	± 0,5 kV ± 1 kV ± 2 kV	± 0,5 kV ± 1 kV ± 2 kV	The quality of the supply voltage should be that of a typical commercial or hospital environment.
Magnetic field at the supply frequency (50/60 Hz) EN 61000-4-8	30 A/m 50/60 Hz	30 A/m 50/60 Hz	Magnetic fields at the mains frequency should correspond to the typical values found in a business and hospital environment.
Voltage dips, short interruptions and fluctuations in the supply voltage EN 61000-4-11	<5 % UT (>95 % dip in UT) for ½ cycle <5 % UT (>95 % dip in UT) for 1 cycle 70 % UT (30 % dip in UT) for 25/30 cycles <5 % UT (>95 % dip in UT) for 5/6s	<5 % UT (>95 % dip in UT) for ½ cycle <5 % UT (>95 % dip in UT) for 1 cycle 70 % UT (30 % dip in UT) for 25/30 cycles <5 % UT (>95 % dip in UT) for 5/6s	The quality of the supply voltage should correspond to that of a typical business or hospital environment. If the user of the device demands continued operation even if there are interruptions in the energy supply, it is recommended that the device be fed from an uninterruptible power supply or battery.
Conducted disturbances induced by RF fields EN 61000-4-6	3 V/m 1 kHz 80% AM  150 kHz bis 80 MHz	3 V/m	
Radiated RF disturbances EN 61000-4-3	3 V/m 1kHz 80% AM  80 MHz to 2.7 GHz	3 V/m	See table below
NOTE: These guidelines may not apply in all situations. Electromagnetic propagation is affected by absorption and reflection from structure, objects and people.			

Test Frequency in MHz	Frequency Band in MHz	Service in MHz	Modulation	Immunity Testing Level in V/m
385	380 - 390	TETRA 400	Pulse modulation: 18 Hz	27
450	430 – 470	GMRS 460, FRS 480	FM ±5 kHz Deviation 1 kHz Sine	28
710 745 780	704 – 787	LTE Band 13, 17	Pulse modulation: 217 Hz	9
810 870 930	800 – 960	GSM 800/900, TETRA 800, iDEN 820, CDMA 850, LTE Band 5	Pulse modulation: 18 Hz	28
1720 1845 1970	1700 - 1990	GSM 1800, CDMA 1900, GSM 1900, DECT, LTE Band 1, 3, 4, 25, UMTS	Pulse modulation: 217 Hz	28
2450	2400 – 2570	Bluetooth, WLAN, 802.11 b/g/n, RFID 2450, LTE Band 7	Pulse modulation: 217 Hz	28
5240 5500 5785	5100 - 5800	WLAN, 802.11 a/n	Pulse modulation: 217 Hz	9

## 7 Technical Data

### 7.1 Dimensions

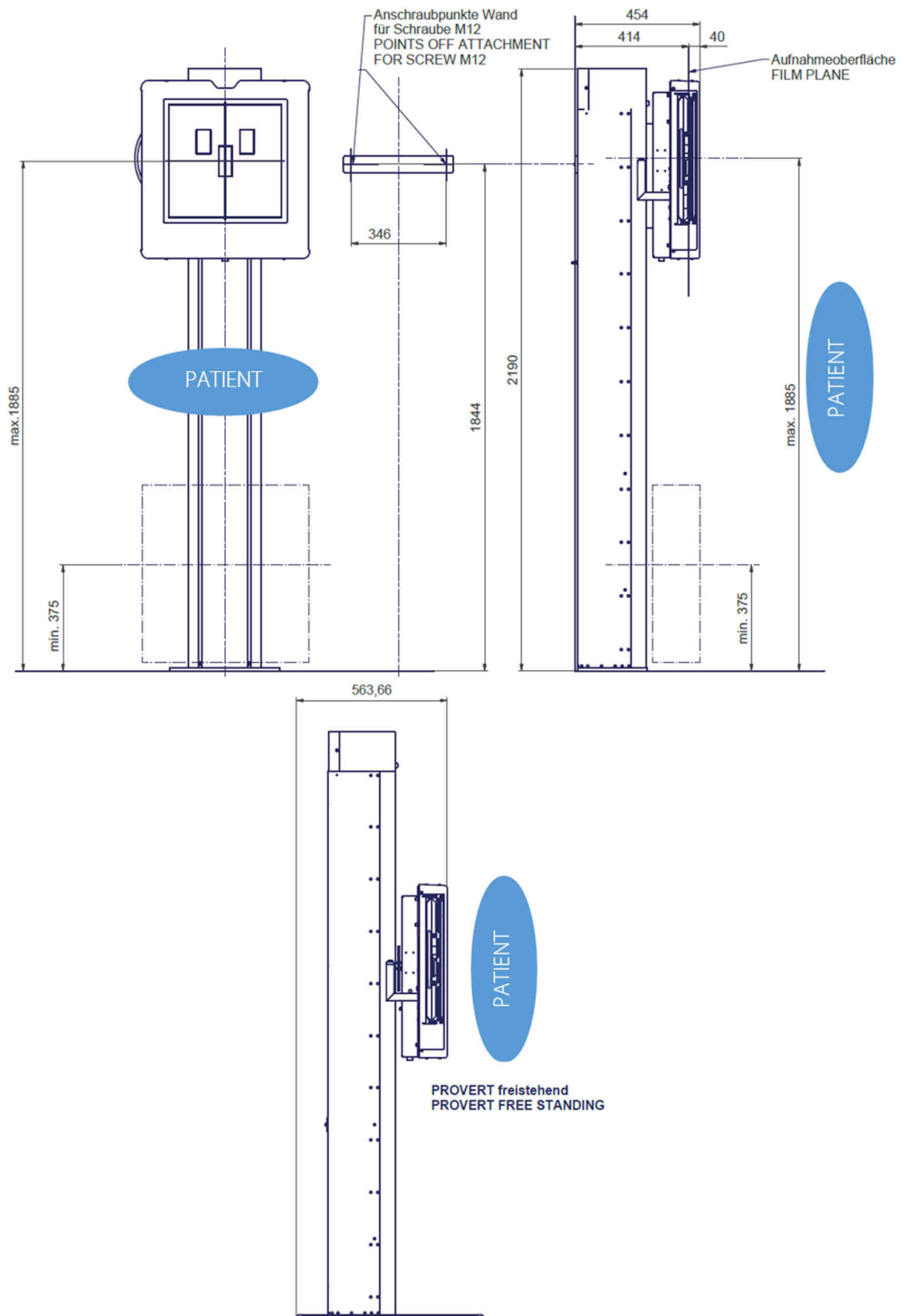

Vertical shift film center

375-1885 mm

## 7.2 Attenuation Equivalent

---



### CAUTION!

**The attenuation equivalent of the PROVERT may have to be considered during the acceptance test of the X-ray system.**

---

The Bucky cover of the image receptor stand is defined as an applied part.

The aluminium attenuation equivalent of the Bucky cover hood is typically 0,4 and < 0,5 Al mm according to EN 60601-1-3. Tested at 100 kV with a first half-value layer thickness (HVL) of 3.6 mm Al.

### 7.2.1 Protection Type and Protection Class

The PROVERT corresponds to protection class 1 and contains applied parts type B (according to EN 60601-1).

## 7.3 Environmental Conditions

### 7.3.1 Environmental Conditions during Operation













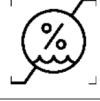



Ambient Temperature	+ 10°C to + 40°C
Relative humidity	30% to 75% (non-condensing)
Atmospheric pressure	700 hPa to 1060 hPa

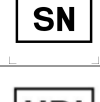

### 7.3.2 Environmental Conditions for Shipping and Storage

Ambient Temperature	- 10°C to + 70°C
Relative humidity	10% to 95% (non-condensing)
Atmospheric pressure	500 hPa to 1060 hPa

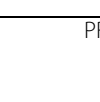
## 8 Description of Symbols, Labels and Abbreviations

### 8.1 Symbols

	Atmospheric pressure limit
	Temperature limit
	Humidity limit
	Keep dry
	Fragile, handle with care
	This way up
	Attention, observe accompanying documents
	Refer to Instructions for use
	CE marking
	Manufacturer
	Medical Device
	Order number
	Serial number
	Unique Device Identification
	Production date
	Classification according to EN 60601-1 (type B applied part)
 <a href="http://www.protec-med.com/download">www.protec-med.com/download</a>	This symbol indicates the need to observe the instructions for use. This is provided in an electronic format (eIFU) on our website.

	<p>Note on disposal; WEEE, Waste of Electrical and Electronic Equipment</p>
	<p>Protective earthing</p>
	<p>Caution: possibility of feet crushing</p>

### 8.2 Type Label

**MD**

**REF** 7401-5-8000

**SN** SNxxxxxx

2025-07-09

www.protect-med.com/download

+10 °C    +40 °C    1060 hPa    75%  
700 hPa    30%

**PROVERT**

Diagnostic X-ray system image receptor floor stand

**POWER RATING**

24	V
1	A

CE

**PROTEC**



PROTEC X-ray Systems GmbH  
In den Dorfwiesen 14  
71720 Oberstenfeld  
Germany

**UDI** 

(01)04260502642085  
(11)250709  
(21)SNxxxxxx

TL 7401-5-8000V04

### 8.3 Labels

<p>Labels on the image receptor stand</p>	
	<p>Refer to instruction for use.</p>
	<p>Caution: Possible pinch-/crushing hazard of feet while moving the Bucky.</p>

## 8.4 Positions of the Signs and Labels

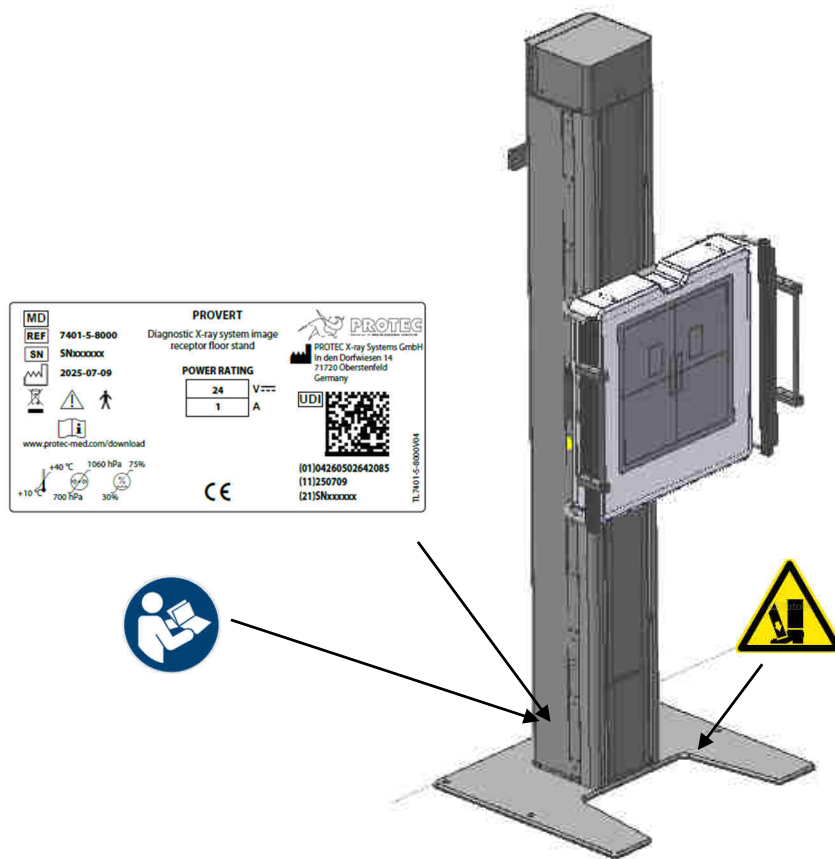

## 8.5 Abbreviations

mm	Millimetre
cm	Centimetre
lb	Pound
kg	Kilogram
°C	Degree -Celsius
hPa	Hectopascal
DIN	German Industry Standard
EN	European Standard
CE	CE-Mark
Hz	Hertz
ED	Duty cycle
A	Ampere
SN	Serial number
Inch	Inches