

Bucky/Bucky WR Grid Entity/Grid Entity WR

X-ray film cassette holder

Bucky - Model/ID: 7051-x-x1xx
Basic UDI-DI: 426050264X018ZU

Bucky WR - Model/ID: 7051-x-x1xx
Basic UDI-DI: 426050264X025ZR

Grid Entity - Model/ID: 7051-0-x5xx
Basic UDI-DI: 426050264X019ZW

Grid Entity WR - Model/ID: 7051-0-x1xx
Basic UDI-DI: 426050264X026ZT

Instructions for use

ID no. 5051-0-8002

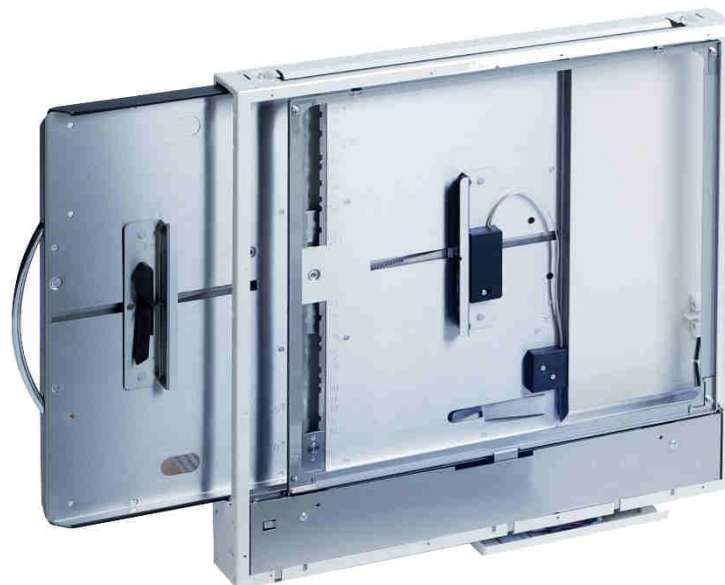

CE



NOTE

All sheets of this document contain proprietary and confidential information of PROTEC X-ray Systems GmbH and is intended for exclusive use by current PROTEC X-ray Systems GmbH customers. Copying, disclosure to others or other use is prohibited without the express written consent of PROTEC's law department. Knowledge of violations of these regulations must be reported immediately to PROTEC X-ray Systems GmbH.

© 2025 PROTEC X-ray Systems GmbH, Oberstenfeld

Comments and questions about the documentation, please contact:

PROTEC X-ray Systems GmbH

In den Dorfwiesen 14 | 71720 Oberstenfeld
Germany

Phone: (+ 49) 7062 – 92 55 0

Fax: (+ 49) 7062 – 92 55 60

E-Mail: protec@protec-med.com

Internet: www.protec-med.com

Table of contents

	Page
Table of contents	3
Revision Status	5
General Notes	6
Mechanical and Electric Warning	6
To the User	6
1 Device Description	7
1.1 Introduction	7
1.2 Description.....	7
1.2.1 Versions	7
1.2.2 Installation	7
1.3 Performance Characteristics	8
1.4 Intended Use	8
1.5 Clinical Benefit	8
1.6 Patient Target Group(s)	8
1.7 Medical Conditions to be diagnosed	8
1.8 Indications and Contraindications	8
1.9 Intended User Group.....	8
1.10 Declaration of Conformity.....	9
2 Safety Instructions	10
2.1 General Safety Instructions	11
2.1.1 Requirements for operation	11
2.1.2 Device Operation	11
2.1.3 Operating Personnel	11
2.1.4 Crushing and Collision Hazard	11
2.1.5 Explosion Protection	11
2.1.6 Interaction with Other Devices.....	11
2.1.7 Electromagnetic Environment and Influencing of Devices	12
3 Control Elements and Displays	13
3.1 Main Switch of the X-ray cassette holder	13
3.2 Control Elements and Displays of the X-ray cassette holder	13
4 Handling	15
4.1 Requirements before and during Operation.....	15
4.2 Operation of the X-ray cassette holder	15
4.2.1 Insertion and Removal of the Grid Frame	15
4.2.2 Inserting an image receiver into the cassette drawer	16
4.2.3 Inserting an image receiver in a variant with loading functionality (DL)	16
4.3 Function of the X-ray cassette holder	17
4.3.1 Switching the X-ray cassette holder on and off	17
5 Safety and Maintenance	18
5.1 Introduction	18
5.2 Reusability	18
5.3 Cleaning and Disinfection	18
5.3.1 Cleaning.....	18
5.3.2 Disinfection	18
5.4 Inspection and maintenance	19
5.4.1 Daily Monitoring before and during the Examination Operation.....	19
5.4.2 Regular Monitoring	19
5.4.3 Maintenance	19
5.4.4 Warranty.....	19
5.4.5 Product Service Life	20
5.4.6 Further Information	20
5.4.7 Disposal Notes	20

6	Power Supply	21
6.1	Electromagnetic Compatibility (EMC) according to EN 60601-1-2	21
6.1.1	Guidelines and Manufacturer's Declaration – Electromagnetic Interference.....	21
7	Technical Data.....	24
7.1	Dimensions.....	24
7.2	Attenuation Equivalent.....	24
7.2.1	Protection Type and Protection Class	24
7.3	Environmental Conditions	24
7.3.1	Environmental Conditions during Operation.....	24
7.3.2	Environmental Conditions for Shipping and Storage	24
8	Description of Symbols, Labels and Abbreviations	25
8.1	Symbols	25
8.2	Type Labels.....	26
8.3	Labels	27
8.4	Positions of the signs and labels	27
8.5	Abbreviations	27

**NOTE**

The information contained in this document conforms to the configuration of the equipment as of the date of manufacture. Revisions to the equipment subsequent to the date of manufacture will be addressed in service updates distributed to the PROTEC Technical Service Organisation.

Revision Status

Revision	Date	Updated pages	Comments	Author
1.0	2021-05-25	all	Inversion to MDR, replaces 5051-0-0051_V02 5051-0-0251_V2.0 5051-0-0151_V4.0 5051-0-0001_Rev06 5051-0-0021_Rev04	MB
2.0	2022-10-26	10 16-17 26-27	Reference to form changed, Image from DL (revised variant) replaced; Added description of inserting a panel into the cassette drawer with DL and added a warning; Stickers added to pictograms and positions of signs and stickers	ML TB
3.0	2025-07-15	All	First edition PROTEC X-ray Systems GmbH	ML

General Notes

**WARNING!**

In order to maintain the set and tested requirements of the 60601 series of standards, the ME system must not be modified during its actual operating life.

Mechanical and Electric Warning

**WARNING!**

All of the movable assemblies and parts of this equipment should be operated with care and routinely inspected in accordance with the manufacturer's recommendations contained in the equipment accompanying documents. Maintenance and service is only to be performed by customers authorized by PROTEC X-ray Systems GmbH.

Live electrical terminals are deadly.

Do not remove flexible high-tension cables from X-ray tube cover or high-tension generator and/or access covers from X-ray generator.

For all components of the equipment protective earthing means must be provided in compliance with the national regulations.

Failure to comply with the foregoing may result in serious or fatal bodily injuries to the operator or those in the area.

To the User

**NOTE**

The user of these accompanying documents is required to carefully read through and carefully consider the instructions, warnings and cautions contained therein before starting operation.

Even if you have already operated similar systems, changes in the design, production and functional routine of the system described here may have been made, which have a significant influence on the operation.

Assembly and service works on the system described here must be carried out by authorised and qualified personnel from PROTEC X-ray Systems GmbH. Assembly personnel and other persons who are not employees of the technical service department of PROTEC X-ray Systems GmbH are requested to contact the local branch of PROTEC X-ray Systems GmbH before assembly or service work is started. For assembly and service works, it is necessary to use the "Technical Description" of the product and to observe the points it contains.

**NOTE**

The use of the product with add-on or accessory parts not authorized by PROTEC or other unapproved components is not permitted.

**NOTE**

According to Regulation (EU) 2017/745 of medical devices, all serious incidents related to the device must be reported to the manufacturer and the responsible authority of the Member State where the user and/or the patient is established.

1 Device Description

1.1 Introduction

The instructions for use describe the performance characteristics and operation required for efficient and effective use of the X-ray cassette holder.

Before you work with the X-ray cassette holder, the complete instructions for use must be read, especially the Safety Instructions and the chapter Handling.

1.2 Description

The X-ray cassette holder with cassette drawer is designed to accommodate a measuring chamber (for operation of the x-ray generator with automatic exposure control) and an anti-scatter grid.

The anti-scatter grid and measuring chamber with adapters must be ordered separately.

The grid serves to reduce the scattered radiation, which has a contrast-reducing effect on the exposure.

1.2.1 Versions

Bucky	7051-x-010x
Bucky FSE	7051-x-012x
Bucky DL	7051-x-x10x
Bucky FSE DL	7051-x-112x
Bucky WR	7051-x-015x
Bucky WR RA	7051-x-015x
Bucky WR FSE	7051-x-017x
Bucky WR FSE-RA	7051-x-017x
Bucky WR DL	7051-x-315x
Bucky WR FSE DL	7051-x-317x
Grid Entity	7051-0-252x
Grid Entity FSE	7051-0-253x
Grid Entity DL	7051-0-x52x
Grid Entity FSE DL	7051-0-x53x
Grid Entity WR	7051-0-015x
Grid Entity WR FSE-RA	7051-0-015x
Grid Entity WR DL	7051-0-x16x
Grid Entity WR FSE DL	7051-0-x17x

1.2.2 Installation



NOTE

The installation of the X-ray cassette holder must be performed by PROTEC service department or a service company authorized by them.

For more information, please see separate installation manual of the X-ray cassette holder.

Contact information of persons qualified to perform installations are available upon request at:

PROTEC X-ray Systems GmbH

In den Dorfwiesen 14 | 71720 Oberstenfeld
Germany

Phone: (+ 49) 7062 – 92 55 0

Fax: (+ 49) 7062 – 92 55 60

E-Mail: protec@protec-med.com

Internet: www.protec-med.com

1.3 Performance Characteristics

Optional for the use of measuring chambers and anti-scatter grids.

Optional functions, depending on the version:

- Grid Detection (RA)
- Fail Safe (FSE)
- Detector loading for certain Wi-Fi detector models (DL)

Only for X-ray cassette holders with grid exchange (WR): Easy removal of the anti-scatter grid for examinations without grid or for quick changeover to another grid.

1.4 Intended Use

The Bucky X-ray cassette holder...

- Bucky with electronically controlled grid drive
- Bucky WR with a removable grid frame and electronically controlled grid device
- Grid Entity
- Grid Entity WR with a removable grid frame

... is intended to be used as a component of a diagnostic X-ray system for holding and positioning an image receptor, a measuring chamber and an anti-scatter grid for various routine planar X-ray imaging applications in human medicine.

1.5 Clinical Benefit

Considered in isolation, no clinical benefit can be shown for X-ray cassette holders.

As components of diagnostic X-ray systems in human medicine, they contribute to the clinical benefit of X-ray systems, which consists of the generation of conventional two-dimensional X-ray images for creation or specification of findings as a basis for treatment decisions.

1.6 Patient Target Group(s)

The intended patient group includes all people for whom a justifying indication for a medical X-ray has been given by a physician with the necessary expertise in radiation protection.

There are no general or fundamental restrictions on the patient group regarding age, gender, origin and patient condition.

1.7 Medical Conditions to be diagnosed

As standalone products, X-ray cassette holders, have no function to diagnose, treat and/or monitor medical conditions.

1.8 Indications and Contraindications

As standalone products, X-ray cassette holders have no intended main effect in or at the human body. Therefore, considered in isolation, no indications and contraindications can be shown for them.

1.9 Intended User Group

As a component of a diagnostic X-ray system, the X-ray cassette holder is intended exclusively for use by professional users who are trained in the operation of diagnostic X-ray systems in accordance with the respective national regulations and who are familiar with the proper handling, use and operation and also have been instructed in the permitted conjunction with other medical products, objects and accessories.

Appropriate users can be, for example: X-ray technicians, X-ray assistants, medical technical X-ray assistants, surgeons, casualty surgeons, orthopaedists and other trained medical personnel.

1.10 Declaration of Conformity



This product complies with the requirements of Regulation (EU) 2017/745 of the European Parliament and of the Council of 5 April 2017 on medical devices, including all applicable corrigenda.

The declaration of conformity is available upon request from PROTEC:

PROTEC X-ray Systems GmbH

In den Dorfwiesen 14 | 71720 Oberstenfeld

Germany

Phone: (+ 49) 7062 – 92 55 0

Fax: (+ 49) 7062 – 92 55 60

E-Mail: protec@protec-med.com

Internet: www.protec-med.com

2 Safety Instructions



NOTE

Contains information that must be observed during operation.

xxx



CAUTION!

Contains information which, if not observed, can cause property damage.

xxx



WARNING!

Contains information which, if not followed, can cause personal injury.

xxx



WARNING!

Warning of radioactive substances or ionizing radiation. Contains information which, if not observed, can cause personal injury.

xxx

Settings and calibrations that are not described in these instructions for use must be carried out using the technical description of the device by PROTEC service department or a service company authorized by them.



NOTE

All instructions supplied with the X-ray cassette holder must be observed and the safety instructions contained therein must be carefully read and adhered to.



NOTE

After the initial installation, the commissioning must be recorded with the PROTEC acceptance protocol FB-04-07A4.3.



NOTE

The X-ray cassette holder may only be commissioned if all safety measures for operator protection have been met and checked. These protective measures can include door contact, designated area, dosimeter, protective clothing, etc.



CAUTION!

The instructions for use contain all the information relevant to safety in order to generally put the X-ray cassette holder into operation. The device may only be operated by appropriately trained and trained personnel. In this context, operation is ensured by clear symbols on the control elements. All further information and instructions can be found on the supplied data carrier (USB, CD or DVD). This information applies in its entirety as an appendix to these instructions for use and must be observed.



NOTE

All control elements are described again in detail in these operating instructions.

2.1 General Safety Instructions

2.1.1 Requirements for operation



WARNING!

The X-ray cassette holder is a protection class I device (according to EN 60601-1).

To avoid the risk of an electric shock, this device may only be connected to a supply network with a protective earthing conductor.

The power supply for the X-ray cassette holder of the X-ray system is exclusively made by direct connection to the X-ray generator or the Power Box and is permanently connected there. The X-ray generator or the Power Box must have at least 2 connections for 230V 50/60Hz.

The X-ray generator of the X-ray system is connected to the supply network (see technical description of the X-ray generator).

To reduce the risk of electric shock, the system must be connected to a supply network with protective earthing.

The system does not have an on/off switch. It is switched on or off directly by switching on the X-ray generator or by the switch on the Power Box. In order to separate any electrical voltage from the X-ray system, the connected X-ray generator or the Power Box must be switched off.

2.1.2 Device Operation

In case of a malfunction, do not use the X-ray cassette holder anymore and notify PROTEC service department or a service company authorized by them.

2.1.3 Operating Personnel



NOTE

Only trained and authorized personnel are allowed to work on the X-ray cassette holder.



NOTE

The operating personnel must be familiar with all warning signs attached to the X-ray cassette holder. They are used for your own safety and that of others and ensure proper operation.

2.1.4 Crushing and Collision Hazard



WARNING!

It must be ensured that when operating the moving parts of X-ray cassette holder, no persons or objects are in the obvious danger area of the device. If not observed, it can result in personal injury or damage to the X-ray cassette holder or other objects.

2.1.5 Explosion Protection

The X-ray cassette holder is not designated for use within areas with explosive hazards.

2.1.6 Interaction with Other Devices

Interactions with other devices are not known.

2.1.7 Electromagnetic Environment and Influencing of Devices



CAUTION!

The use of other accessories, other converters and other cables than those specified by PROTEC or provided in the documentation of the component manufacturer can result in increased electromagnetic interference or reduced electromagnetic immunity of the device and lead to defective operation.



CAUTION!

The use of the X-ray cassette holder immediately next to other devices or with other devices in a stacked form should be avoided, as this could result in defective operation. If use in the manner described above is nevertheless necessary, the X-ray cassette holder and the other devices should be observed to ensure that they are working properly.



NOTE

The properties of this device, determined by emissions, allow its use in industrial areas and in hospitals (CISPR 11, class A). When used in residential areas (for which class B is usually required by CISPR 11), this device may not provide adequate protection for radio services. The user may need to take remedial measures such as relocating or realigning the device.

The X-ray cassette holder is intended for use in an environment in professional health care facilities (e.g., clinics, surgery centres, physiology practices ...)

3 Control Elements and Displays

3.1 Main Switch of the X-ray cassette holder

The X-ray cassette holder does not have a separate main switch.

The Bucky and Bucky WR variants and all models with detector loading are switched on and off via the X-ray system.

The Grid Entity and Grid Entity WR variants are operated without power.

3.2 Control Elements and Displays of the X-ray cassette holder

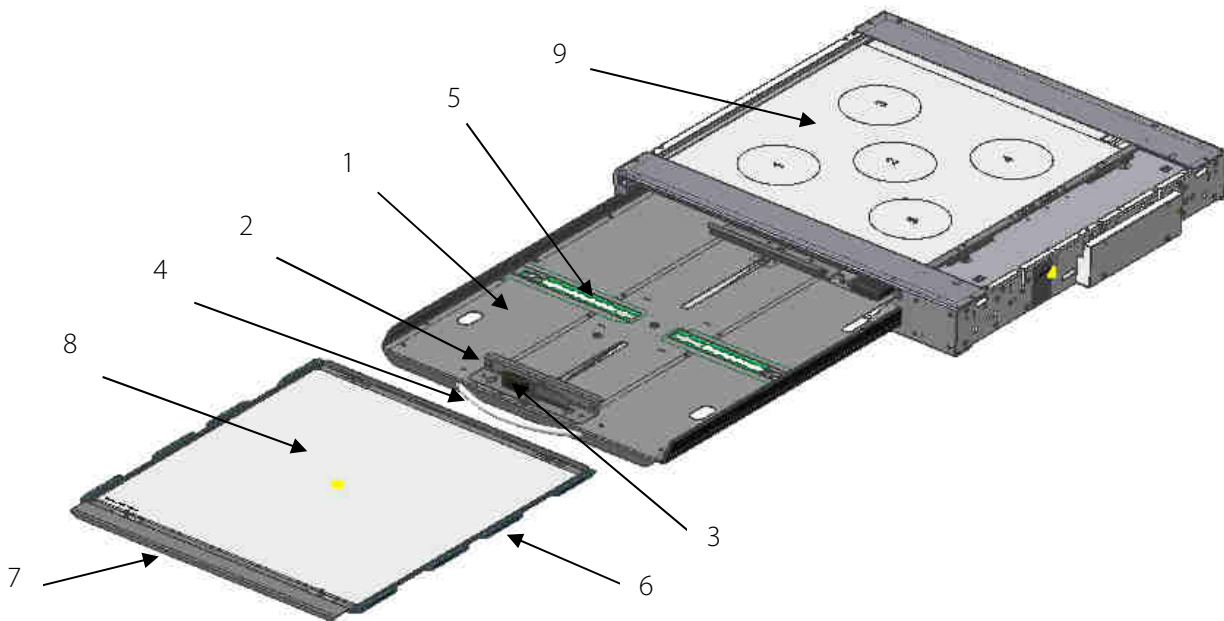

- 1) Cassette drawer, serves to hold the image receiver.
- 2) Clamping device, for automatic centering of the image receiver transverse to the table top.
- 3) Locking latch, for locking the clamping device.
- 4) Handle, after pulling out the cassette drawer to the limit stop, the image receiver can be inserted.
- 5) Positioning, along the table top the image receiver can be positioned manually by hand per alignment to the center markings or by setting to the appropriate image receiver size.
- 6) Exchangeable grid frame, only for Bucky WR and Grid Entity WR variants.
- 7) Handle strip, exchangeable grid frame.
- 8) *Anti-scatter grid.
- 9) *Ionization measuring chamber.

**Is not included in the scope of delivery of the X-ray cassette holder.*

Optional FSE (Fail Safe)

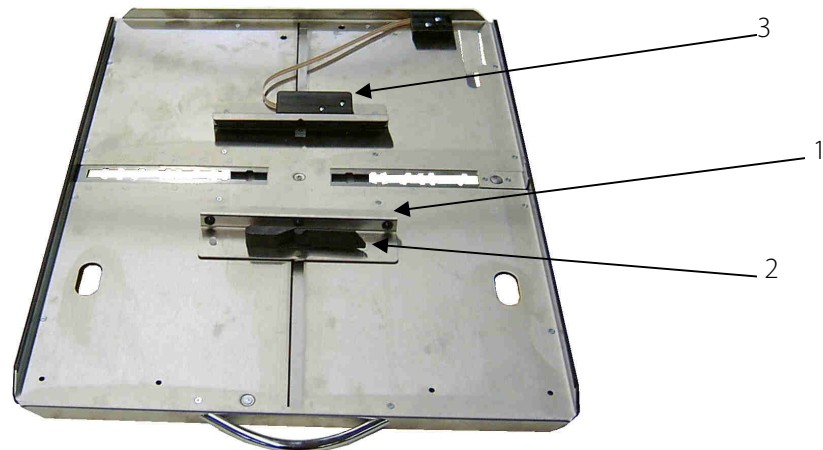

- 1) Clamping device, for automatic centering of the image receiver transverse to the table top.
- 2) Locking latch, for locking the clamping device.
- 3) Cassette scanning (FSE)

The cassette scanning is activated by inserting an image receiver into the cassette drawer and locking it by the clamping device.

4 Handling

4.1 Requirements before and during Operation

It must be ensured that the surfaces in contact with patients are disinfected before the X-ray examination of each patient (see chapter 5.3.2).

4.2 Operation of the X-ray cassette holder

4.2.1 Insertion and Removal of the Grid Frame

Only for version with exchangeable grid frame.

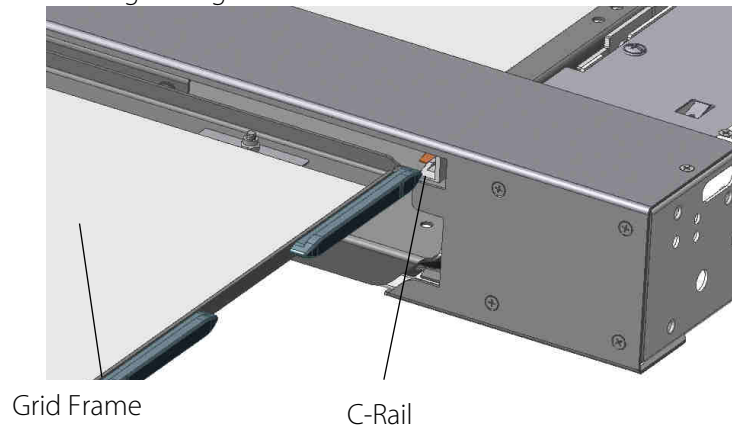

To insert the grid frame, position the grid frame right-aligned in the C-rail and push it in to the tab location. Afterwards, pull gently to check whether the grid frame is locked in place.



CAUTION!

Always handle the anti-scatter grid with two hands and do not drop it.



NOTE

If the grid frame is not correctly inserted and locked, an exposure release is blocked.

To remove the grid frame, pull the handle strip at the front of the grid frame outwards. After a short resistance, the grid frame is unengaged and can be pulled forward. Use both hands to pull the grid frame out of the side rails of the Bucky WR/Grid Entity WR. Store the grid frame safely until the next use.



4.2.2 Inserting an image receiver into the cassette drawer

- An image receiver is inserted into the cassette drawer of the X-ray cassette holder, when the X-ray tube assembly is positioned.



WARNING!

For inserting an image receptor in the cassette drawer with the option of the loading function, see chapter 4.2.3!

- Pull out the cassette drawer by its handle from the X-ray cassette holder until it hits the limit stop.
- Turn the latch for opening/closing the clamping device, for lateral fixation of the image receiver, counter clockwise.
- Open the clamps far enough to insert an image receiver of the desired size.
- Insert the image receiver, with its centreline aligned to the notch in the clamps or by engaging the cassette positioner in the size of the image receiver, push the image receiver to the cassette positioner.
- Push the cassette clamps against the image receiver and rotate the latch clockwise into the locked position.
 - Option FSE: Activation of the cassette scanning.
- Push the cassette drawer fully into the X-ray cassette holder.



NOTE

FSE Option (Fail Safe):

An X-ray exposure is only released if there is a correctly inserted image receiver in the cassette centering device and the cassette drawer has been fully inserted into the X-ray cassette holder.

4.2.3 Inserting an image receiver in a variant with loading functionality (DL)

The loading of the detector only works if the detector is placed in the correct position in the drawer. The charging connector must be on the rear left or right side (according to the detector model) so that contact can be made with the charging plug.

Only when the cassette drawer is closed and the system is switched on, the detector is automatically charged. The display of the battery status depends on the applied software.



CAUTION!

If the X-ray film cassette holder is installed in a table, the image receiver must be pushed all the way to the right after being inserted in the cassette drawer (see item A). Then fix the image receiver using the clamping device.

If the X-ray cassette holder is installed in a wall stand, the image receiver must be inserted flush with the cassette drawer. Before inserting the cassette drawer into the X-ray film cassette holder, press the image receiver in the middle of the cassette drawer (see item B).

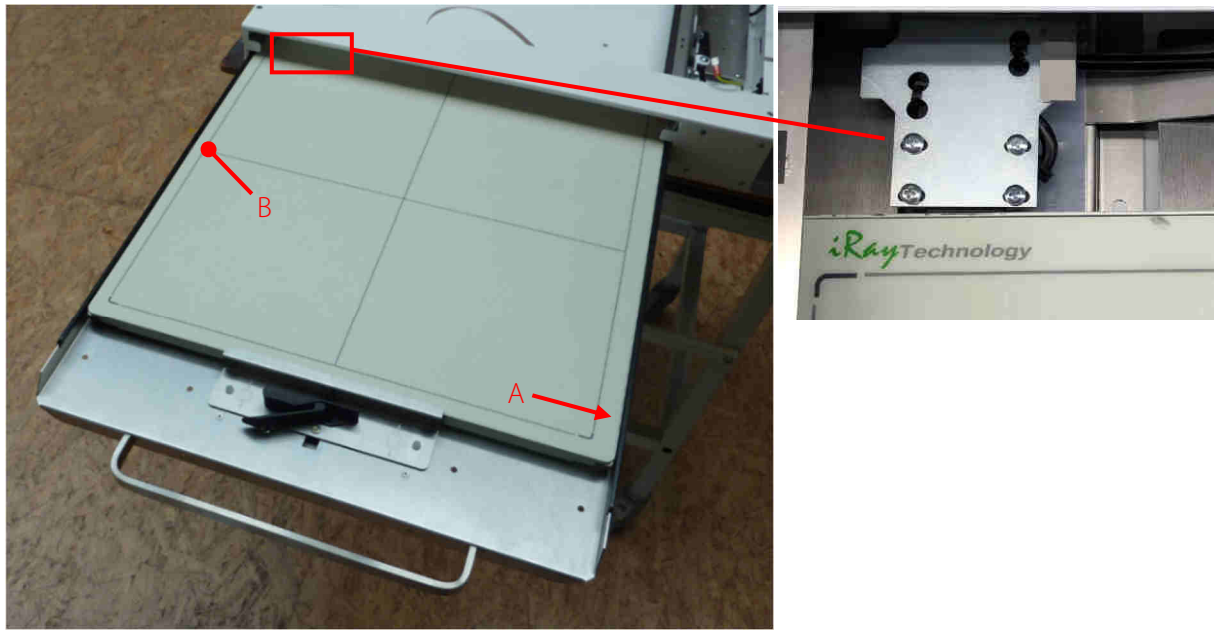

4.3 Function of the X-ray cassette holder

4.3.1 Switching the X-ray cassette holder on and off

The X-ray cassette holder (only Bucky and Bucky WR and variants with detector loading) is switched on via the console of the generator. All system components are supplied with voltage via the generator. If the system contains a Power Box, the power is supplied via the Power Box.

When the generator or Power Box is powered up using the switch-on button, a self-test runs on the generator and the control desk. After successful completion of the self-test, the parameters are displayed.

5 Safety and Maintenance



WARNING!

Caution, risk of electric shock!

Switch off the X-ray system before cleaning or disinfecting. This disconnects the X-ray cassette holder from the power source and avoids the risk of electric shock.

5.1 Introduction

In this chapter you will find information about safety and maintenance that are necessary to ensure the correct and reliable function of the device after installation.

5.2 Reusability

The X-ray cassette holder can be reused without any special preparation procedures.

However, it must be ensured that the surfaces in contact with patients are disinfected before the X-ray examination of each patient (see also chapter 4.1).

The X-ray cassette holder must no longer be used with patients if it shows signs of wear (e.g., metal abrasion, wear of insulations) or dangerous technical defects (e.g., bent parts) or if the resulting image quality (e.g., artifacts in the image) is insufficient.

In this case, please contact PROTEC service department or a service company authorized by them immediately.

5.3 Cleaning and Disinfection



NOTE

Caution!

Possible material changes!



WARNING!

Make sure that no liquid enters the interior of the housing during cleaning and disinfection in order to prevent electrical short circuits and/or corrosion.

5.3.1 Cleaning

The cleaning of the X-ray cassette holder is very easy due to the very good quality surface coating. This is usually only done with a dry cloth.

Do not use corrosive, dissolving or abrasive cleaning agents, which could damage the device surfaces or the coating.

Clean the device surfaces and painted parts with a damp cloth and a mild to slightly alkaline cleaning solution (e.g., RBS® Neutral T) and wipe dry.

Chrome parts may only be wiped with a dry woollen cloth.

5.3.2 Disinfection

The disinfection must be performed in accordance with the current applicable legal requirements and guidelines corresponding for disinfection and explosion protection.

All mechanical parts of the X-ray cassette holder, including accessories, may only be cleaned with a wipe disinfection with suitable surface disinfectants (e.g., Melsept® SF, 15 min. application time at 2% concentration). The information provided by the disinfectant manufacturer on concentrations and application times must be observed.

**WARNING!**

No highly flammable disinfectants may be used! For safety reasons, spray disinfection must not be carried out, as the spray mist could penetrate the device and cause short circuits or corrosion.

If disinfectants are used that can form explosive gas mixtures, the device may only be switched on again when the gas mixtures have evaporated!

5.4 Inspection and maintenance

**WARNING!**

No maintenance or repair work may be performed while the X-ray cassette holder is being used with a patient!

All maintenance and repair work may only be performed by personnel trained or authorized by PROTEC.

5.4.1 Daily Monitoring before and during the Examination Operation

Check the operating elements for proper function.

5.4.2 Regular Monitoring

**NOTE**

Quality assurance measures for X-ray equipment must be carried out at regular intervals in accordance with national regulations, e.g., by means of a monthly constancy test, in Germany.

5.4.3 Maintenance

The required maintenance must be carried out by PROTEC service department or a service company authorized by them in order to ensure the safe and reliable functionality of the device. The maintenance intervals depend on the frequency of use. The required specifications can be found in the corresponding Technical Description in chapter 3 *Maintenance and Safety Inspection*.

In the event that the planned maintenance is not carried out, PROTEC X-ray Systems GmbH assumes no liability whatsoever for damage to the user and third parties if damage results from inadequate or not carried out maintenance.

Prior to the examination operation, the user must satisfy himself that all appliances listed in the operating instructions and serving safety are in working order and that the product is ready for operation.

**NOTE**

Wear parts must be replaced with original components.

5.4.4 Warranty

**NOTE**

You will find the current warranty conditions in your order documents or in the price list valid at the time of purchase.

Repairs and spare parts in the event of improper use are also excluded.

Warranty work may only be carried out by trained specialists.

5.4.5 Product Service Life

The X-ray cassette holder is designed for a service life of 10 years when used in accordance with the specifications and regular maintenance by PROTEC service department or a service company authorized by them. After the product has reached the end of its service life, further use is at your own risk.

5.4.6 Further Information

Detailed information to the individual chapters and for a safe operation, transport or storage can be found in the Technical Description of the X-ray cassette holder.

5.4.7 Disposal Notes



The X-ray cassette holder contains various plastics and heavy metal. When disposing exchange and spare parts, or if necessary, the entire device, the valid rules and regulations must be observed. Please contact your contractual partner or service company or commission a company specialized in disposing the respective components.

6 Power Supply



NOTE

Depending on the model, the X-ray cassette holder requires the following power supply:

Bucky, Bucky WR without or with detector loading functionality Grid Entity, Grid Entity WR with detector loading functionality.

Line voltage	230 VAC
Line frequency	50-60 Hz
Input current	1,5A max.

The power supply for the detector is provided by a power supply unit. This supplies 24VDC, 3A.



WARNING!

To avoid the risk of an electric shock, this device may only be connected to a supply network with a protective earth conductor.

6.1 Electromagnetic Compatibility (EMC) according to EN 60601-1-2



CAUTION!

As a medical electrical device, the X-ray cassette holder is subject to special precautionary measures regarding EMC and must be installed and commissioned in accordance with the EMC information contained in the accompanying documents.



CAUTION!

Portable RF communication devices (radio devices) should not be used closer than 30 cm (12 in) to the marked parts and cables of the X-ray cassette holder. Failure to observe can lead to a reduction in the performance characteristics of the device.

6.1.1 Guidelines and Manufacturer's Declaration – Electromagnetic Interference

The X-ray cassette holder is intended for use in the electromagnetic environment specified below. The customer or the operator of the radiographic system should assure that it is used in such an environment.

Measurement interference	Compliance	Electromagnetic Environment
RF emissions CISPR 11	Group 1	The X-ray component uses RF energy exclusively for its internal function. As a result, its RF emissions are very low and it is unlikely that nearby electronic devices will be influenced.
RF emissions CISPR 11	Class A	The device is suitable for use in facilities other than residential areas and those that are directly connected to the public supply network, which also supplies
Harmonic emissions	Class A	

EN 61000-3-2		buildings that are used for residential purposes, provided the following warning is observed: Warning: This device is intended for use by medical professionals only. This is a class A device according to CISPR 11. This device can cause radio interference in residential areas, in which case it must be necessary to take appropriate remedial measures such as new alignment, rearrangement or shielding of the device or filtering of the connection to the location.
Voltage fluctuations/ flicker emissions EN 61000-3-3	compliant	

Immunity Test	EN 60601-1-2 Test Level	Compliance Level	Electromagnetic Environment - Guidance
Electrostatic discharge (ESD) EN 61000-4-2	± 8 kV contact discharge ± 2 kV, ± 4 kV, ± 8 kV, ± 15 kV air discharge	± 8 kV contact discharge ± 2 kV, ± 4 kV, ± 8 kV, ± 15 kV air discharge	Floors should be made of wood, concrete or ceramic tiles. If the floor is covered with synthetic material, the relative humidity must be at least 30%.
Fast transient electrical disturbance variables / burst EN 61000-4-4	± 2 kV for power supply lines ± 1 kV for input/output lines	± 2 kV for power supply lines ± 1 kV for input/output lines	The quality of the supply voltage should correspond to that of a typical business or hospital environment.
Surges EN 61000-4-5	± 0,5 kV ± 1 kV ± 2 kV	± 0,5 kV ± 1 kV ± 2 kV	The quality of the supply voltage should be that of a typical commercial or hospital environment.
Magnetic field at the supply frequency (50/60 Hz) EN 61000-4-8	30 A/m 50/60 Hz	30 A/m 50/60 Hz	Magnetic fields at the mains frequency should correspond to the typical values found in a business and hospital environment.
Voltage dips, short interruptions and fluctuations in the supply voltage EN 61000-4-11	<5 % UT (>95 % dip in UT) for ½ cycle <5 % UT (>95 % dip in UT) for 1 cycle 70 % UT (30 % dip in UT) for 25/30 cycles <5 % UT (>95 % dip in UT) for 5/6s	<5 % UT (>95 % dip in UT) for ½ cycle <5 % UT (>95 % dip in UT) for 1 cycle 70 % UT (30 % dip in UT) for 25/30 cycles <5 % UT (>95 % dip in UT) for 5/6s	The quality of the supply voltage should correspond to that of a typical business or hospital environment. If the user of the device demands continued operation even if there are interruptions in the energy supply, it is recommended that the device be fed from an uninterruptible power supply or battery.
Conducted disturbances induced by RF fields EN 61000-4-6	3 V/m 1 kHz 80% AM 150 kHz bis 80 MHz	3 V/m	

Radiated RF disturbances EN 61000-4-3	3 V/m 1kHz 80% AM 80 MHz to 2.7 GHz	3 V/m	See table below
NOTE: These guidelines may not apply in all situations. Electromagnetic propagation is affected by absorption and reflection from structure, objects and people.			

Test Frequency in MHz	Frequency Band in MHz	Service in MHz	Modulation	Immunity Testing Level in V/m
385	380 - 390	TETRA 400	Pulse modulation: 18 Hz	27
450	430 – 470	GMRS 460, FRS 480	FM ±5 kHz Deviation 1 kHz Sine	28
710 745 780	704 – 787	LTE Band 13, 17	Pulse modulation: 217 Hz	9
810 870 930	800 – 960	GSM 800/900, TETRA 800, iDEN 820, CDMA 850, LTE Band 5	Pulse modulation: 18 Hz	28
1720 1845 1970	1700 - 1990	GSM 1800, CDMA 1900, GSM 1900, DECT, LTE Band 1, 3, 4, 25, UMTS	Pulse modulation: 217 Hz	28
2450	2400 – 2570	Bluetooth, WLAN, 802.11 b/g/n, RFID 2450, LTE Band 7	Pulse modulation: 217 Hz	28
5240 5500 5785	5100 - 5800	WLAN, 802.11 a/n	Pulse modulation: 217 Hz	9

7 Technical Data

7.1 Dimensions

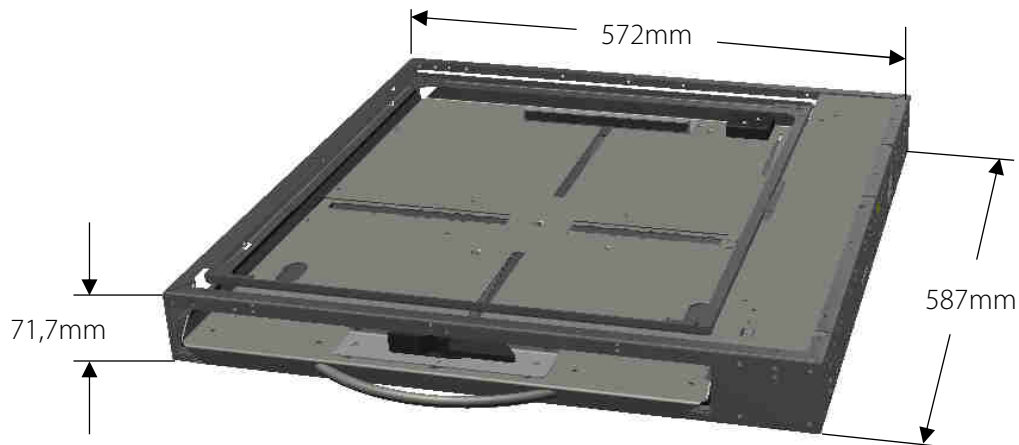

7.2 Attenuation Equivalent

The X-ray cassette holder does not have a device attenuation factor. Only the insertion of measuring chambers or anti-scatter grids results in further attenuation equivalences for the X-ray system.

7.2.1 Protection Type and Protection Class

The X-ray cassette holder corresponds to protection class 1 and contains no applied parts type B (according to EN 60601-1).

7.3 Environmental Conditions

7.3.1 Environmental Conditions during Operation















Ambient temperature	+ 10°C to + 40°C
Relative humidity	30% to 75% (non-condensing)
Atmospheric pressure	700 hPa to 1060 hPa





7.3.2 Environmental Conditions for Shipping and Storage

Ambient Temperature	- 10°C to + 70°C
Relative humidity	10% to 95% (non-condensing)
Atmospheric pressure	500 hPa to 1060 hPa

8 Description of Symbols, Labels and Abbreviations

8.1 Symbols

	Atmospheric pressure limit
	Temperature limit
	Humidity limit
	Keep dry
	Fragile, handle with care
	This way up
	Attention, observe accompanying documents
	Refer to Instructions for use
	CE-marking
	Manufacturer
	Medical Device
	Order reference
	Serial number
	Unique Device Identification
	Production date

	<p>Caution: pinch-/crushing hazard for hands and fingers</p>
 <p>www.protec-med.com/download</p>	<p>This symbol indicates the need to observe the instructions for use. This is provided in an electronic format (eIFU) on our website.</p>
	<p>Disposal instructions; WEEE (Waste of Electrical and Electronic Equipment)</p>
	<p>Protective earthing</p>
	<p>Slide the image receiver in the direction of the arrow until it is flush with the edge of the cassette drawer.</p>

8.2 Type Labels

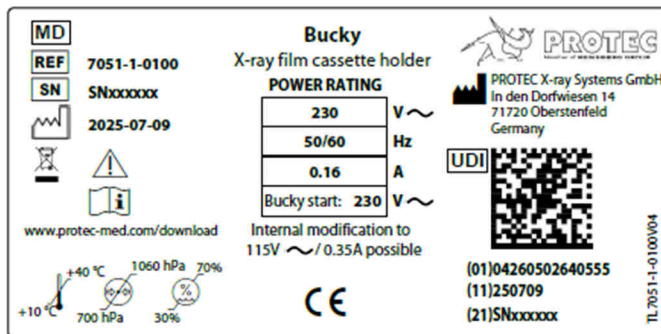

Example Bucky

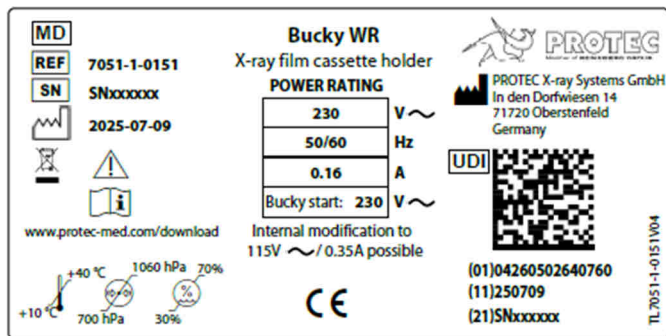

Example Bucky WR

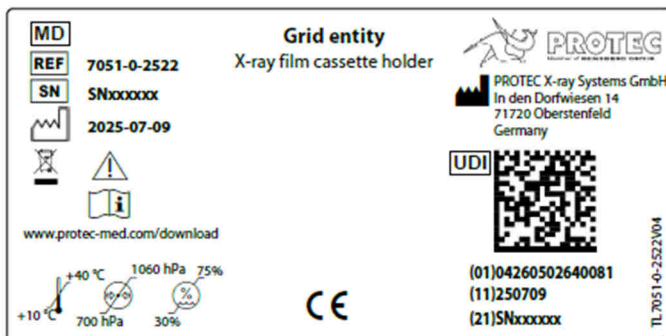

Example Grid Entity

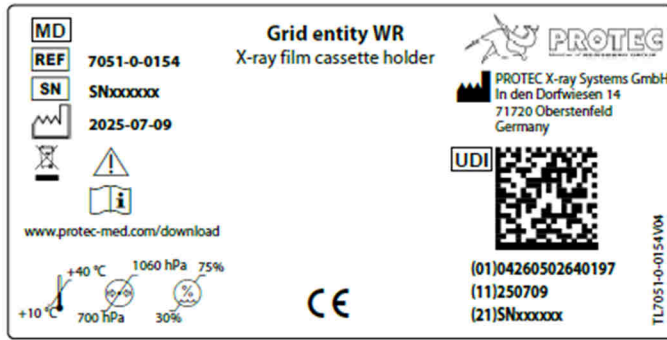

Example Grid Entity WR

8.3 Labels



Refer to Instructions for use



Slide the image receiver in the direction of the arrow until it is flush with the edge of the cassette drawer.

8.4 Positions of the signs and labels

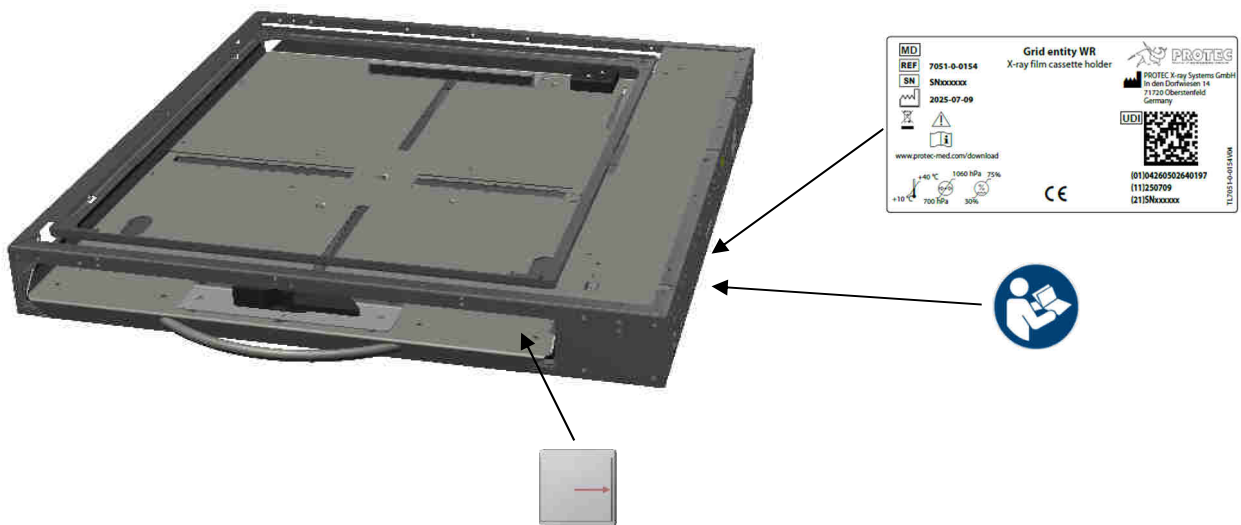

8.5 Abbreviations

Mm	Millimetres
cm	Centimetres
lb.	Pound
Kg	Kilogram
°C	Degree - Celsius
hPa	Hectopascal
DIN	German Industry Standard
EN	European Standard
CE	CE marking
Hz	Hertz
ED	Duty Cycle
A	Ampere
SN	Serial number