

# PRS 500 B

## Stationary basic diagnostic X-ray system

**Model/ID: 7014-9-0000\_Vxxx**

Basic-UDI-DI: 426050264X001ZB

### Instructions for use

Ident. Nr. 5014-0-0002



# CE 0297

**NOTE**

All sheets of this document contain proprietary and confidential information of PROTEC X-ray Systems GmbH and is intended for exclusive use by current PROTEC X-ray Systems GmbH customers. Copying, disclosure to other or other use is prohibited without the express written authorization of PROTEC's law department. Report any violations of this requirement to PROTEC X-ray Systems GmbH.

---

© 2025 PROTEC X-ray Systems GmbH, Oberstenfeld

Comments and questions about the documentation, please contact:

**PROTEC X-ray Systems GmbH**

In den Dorfwiesen 14 | 71720 Oberstenfeld

Germany

Phone: (+ 49) 7062 – 92 55 0

Fax: (+ 49) 7062 – 92 55 60

E-Mail: [protec@protec-med.com](mailto:protec@protec-med.com)

Internet: [www.protec-med.com](http://www.protec-med.com)

## Table of contents

	Page
<b>Table of contents</b> .....	<b>3</b>
<b>Document Effectivity</b> .....	<b>6</b>
<b>General Notes</b> .....	<b>7</b>
<b>Mechanical – Electric Warning</b> .....	<b>7</b>
<b>Radiation Warning</b> .....	<b>7</b>
<b>To the User</b> .....	<b>8</b>
<b>1 Product description</b> .....	<b>9</b>
1.1 Introduction.....	9
1.2 Description.....	9
1.2.1 Equipment components.....	9
1.2.2 Installation.....	10
1.2.2.1 Floor capacity.....	10
1.3 Product specific characteristics.....	10
1.3.1 Variable height radiographic table.....	10
1.3.2 Vertical Bucky Wall Stand.....	11
1.4 Intended use.....	11
1.5 Indication and Contraindication.....	11
1.5.1 Indications.....	11
1.5.2 Contra indications.....	12
1.6 Intended user group.....	12
1.7 Conformity.....	12
<b>2 Safety Instructions</b> .....	<b>13</b>
2.1 General safety notice.....	15
2.1.1 Requirements for operation.....	15
2.1.2 Operating of the radiographic system.....	15
2.1.2.1 Operating type.....	15
2.1.3 Operating personnel.....	15
2.1.4 Pinching and Collision Hazards.....	16
2.1.5 Explosion protection.....	16
2.1.6 Radiation protection.....	16
2.1.7 Ventilation.....	16
2.1.8 Interaction with external devices.....	16
2.1.9 Electromagnetic Environment and the influence of devices.....	17
<b>3 Control elements and device displays</b> .....	<b>18</b>
3.1 Control elements and device displays Basic X-ray system table.....	18
3.2 Control elements and device displays collimator.....	18
3.3 Control elements and device displays of X-ray tube.....	18
3.4 Control elements and device displays of X-ray generator.....	18
3.5 Control elements of Bucky, Grid entity.....	18
3.6 Control elements and device displays of vertical wall stand.....	18
3.7 Control elements and device displays of RAPIXX system.....	18
3.8 Control elements and device displays of CONAXX 2.....	18
3.8.1 CONAXX 2 status messages on the touch PC.....	19
<b>4 Handling / Operation</b> .....	<b>21</b>
4.1 Operation with the radiographic system.....	21
4.1.1 Operation at the X-ray table.....	21
4.1.1.1 Releasing the tabletop brake and positioning the tabletop.....	21
4.1.1.2 Position of patients on the tabletop.....	21
4.1.1.3 Setting the X-ray unit to the mid of movable Bucky, Grid entity.....	21
4.1.1.4 Inserting an image receptor into the cassette tray.....	22
4.1.1.5 Adjusting the source to image-detector distance (SID).....	22
4.1.1.6 Adjusting the light resp. X-ray field.....	22

4.1.1.7	Exposure preparation / exposure release .....	22
4.1.1.8	On table exposures.....	23
4.1.1.9	Exposures with the lateral detector holder (optional) .....	23
4.1.2	Operation at vertical wall stand.....	25
4.1.2.1	Anti-collision sensor .....	25
4.1.2.2	Adjustment of the X-ray unit to the mid of a cassette or Bucky/Grid entity of a X-ray table (horizontal center beam).....	25
4.1.2.3	Adjustment of the source to image-receptor distance (SID).....	25
4.1.2.4	Adjustment of the light-/ radiation field.....	25
4.1.2.5	Exposure preparation/ release .....	26
4.1.3	Operation collimator .....	26
4.1.4	Operation X-ray Tube .....	26
4.2	Operation X-ray generator .....	26
4.3	Operation Bucky, Grid entity.....	27
4.4	Operation RAPIXX system.....	27
4.5	Operation Software .....	27
4.6	Function of the PRS 500 B .....	28
4.6.1	Switching on the PRS 500 B.....	28
4.6.2	Switching off the PRS 500 B.....	29
4.7	Exposure automatic .....	30
<b>5</b>	<b>Safety and Maintenance.....</b>	<b>31</b>
5.1	Introduction .....	31
5.2	Cleaning and disinfection.....	31
5.2.1	Cleaning.....	31
5.2.2	Disinfection.....	31
5.3	Check-up and maintenance .....	32
5.3.1	Daily Controls (prior to or during the unit operation) .....	32
5.3.2	Regular controls .....	32
5.3.3	Maintenance .....	32
5.3.4	Warranty.....	32
5.3.5	Product life time.....	32
5.3.6	Further Information .....	32
5.3.7	Applied Parts and parts which get handled like an application part.....	33
5.3.8	Disposal .....	33
<b>6</b>	<b>Electrical data.....</b>	<b>34</b>
6.1	Electromagnetic Compatibility (EMC) after EN 60601-1-2 .....	35
6.1.1	Guidelines and Manufacturers declaration – electromagnetic interference (non-life supporting device).....	35
<b>7</b>	<b>Technical Data.....</b>	<b>39</b>
7.1	Dimensions.....	39
7.2	X-ray table .....	40
7.3	Bucky, Grid entity .....	40
7.4	X-ray column .....	40
7.5	Wall column stand .....	40
7.6	Attenuation Equivalent.....	41
7.6.1	Protection Art and Protection Class.....	41
7.7	Automatic cutoff dose.....	41
7.7.1	Analogue System .....	41
7.7.2	Digital System.....	41
7.8	Environmental .....	41
7.8.1	Environmental conditions during operation .....	41
7.8.2	Environmental Conditions for Shipping and Storage .....	41
<b>8</b>	<b>Description of symbols, labels and abbreviations.....</b>	<b>42</b>
8.1	Symbols .....	42
8.2	Type label .....	44
8.3	Labels .....	44
8.4	Position symbols and labels.....	46

8.5 Abbreviations.....46

**NOTE**

The information contained in this document conforms to the configuration of the equipment as of the date of manufacture. Revisions to the equipment subsequent to the date of manufacture will be addressed in service updates distributed to the PROTEC Technical Service Organization.

**Document Effectivity**

Revision	Date	Effective pages	Comments	Autor
1.0	14/02/2018	all	Original issue	
2.0	08/06/2018	6, 9, 10, 19, 20	Radiation warning, Detector size customized, switching on/off the system, displayed SID	
3.0	10/10/2018		New component, Venus 50R 1phase	
4.0	30/01/2020	20-22, 25	Anti-collision sensor, lateral detector holder, switching on and off PRS 500 B	
5.0	2020-11-12	Chap. 6	New Generators	
6.0	2022-04-26	34	Figure changed	MB
6.1	2023-02-28	Chap. 1.2.1	Optional accessories corrected	ML
6.2	2023-04-14	35	Technical Data updated	MB
6.3	2023-06-30	36, 37, 39	Value temperature & humidity updated, symbols updated, type label updated	MB
6.4	2023-10-27	Chap. 3.8.1; Chap. 8.1; Chap. 4.6.3; Chap. 2.1.4; Chap. 4.1; Chap. 4.1.1	Touch PC status message added; Symbols added; PROVARIO HF dosimetric calibration removed; Note collision added; Rotation warning added; Warnings about safety distance and motorisation added	DP
6.5	2024-04-18	Chap. 4.1.1.6, 4.1.2.4; Chap. 4.1.1; 4.1.2  Chap. 4.1.1.1; Chap. 4.6.1/4.6.2	Note system accuracy and focusing bucky centre added, "Cassette" replaced by "image receptor" "Releasing tabletop brake" added; Switching on and off optimised	TB DP
6.6	2025-07-18	all	First edition "PROTEC X-ray Systems GmbH"	DP

## General Notes

---



### **WARNING!**

**No changes of the ME device!**

---

## Mechanical – Electric Warning

---



### **WARNING!**

All of the movable assemblies and parts of this equipment should be operated with care and routinely inspected in accordance with the manufacturer's recommendations contained in the equipment Accompanying Documents.

Maintenance and service is only to be performed by Customers authorized by PROTEC X-ray Systems GmbH.

Live electrical terminals are deadly.

Do not remove flexible high-tension cables from X-ray tube housing or high-tension generator and/or access covers from X-ray generator.

For all components of the equipment protective earthing means must be provided in compliance with the national regulations.

Failure to comply with the foregoing may result in serious or fatal bodily injuries to the operator or those in the area.

---

## Radiation Warning

---



### **WARNING!**

The component of the equipment described within this Document is part of a system for the intended generation of X-rays for medical diagnosis.

X-rays generate a potential risk for both patients and operators.

For this reason, the application of X-rays for a given medical purpose must aim at the minimization of radiation exposition to any persons. Those persons responsible for the application must have the specific knowledge according to legal requirements and regulations and must establish safe exposure procedures for these kinds of systems. Those persons, responsible for the planning and installation of this equipment, must observe the national regulations.

The system causes different ionising radiation. The purpose is to create characteristic X-ray radiation. The intensity depends on the adjusted values of voltage, current and time. The radiation comes orthogonal out of the X-ray tube and is limited by the collimator.

---

---

## To the User

---



### NOTE

The user of this Document is directed to read and carefully review the instructions, warnings and cautions contained herein prior to beginning operation, installation or service activities.

While you may have previously operated equipment similar to that described in this Document, changes in design, manufacture or procedure may have occurred which significantly affect the present operation.

Although the product was subject to a risk analysis and the design corresponds to the current state of the art, residual risk will remain in clinical use. These are displayed in the following user manual by application limitations, contraindications, warnings and precautions.

The installation and service of equipment described herein is to be performed by authorized, qualified **PROTEC X-ray Systems GmbH** Customers.

Assemblers and other Customers not employed by nor directly affiliated with **PROTEC X-ray Systems GmbH** technical services are directed to contact the local **PROTEC X-ray Systems GmbH** office before attempting installation or service procedures.

For Installations and service procedures it is necessary to read the „technical description“ of the product and to observe any containing point in it.

---



### NOTE

The usage of the product in combination with accessories which aren't authorized by PROTEC is forbidden.

---

# 1 Product description

## 1.1 Introduction

This user manual describes the special features and operational aspects of the PRS 500 B, knowledge of which are required for efficient and effective use of the radiographic system.

Prior to working with the PRS 500 B, it is required that the user read the Safety Notes as well as the chapter regarding operation.

## 1.2 Description

The PRS 500 B radiography system is a motorized X-ray system with an autotracking function for versatile applications and a high workload. Due to the integrated sophisticated autotracking functions the system enables the user a comfortable, fast and efficient daily workflow. This complete system delivers excellent exposure quality supporting any kind of X-ray examinations in radiological centers, clinics and hospitals, regardless whether it is used for analog or digital imaging techniques.

### 1.2.1 Equipment components

The PRS 500 B can be equipped or customized with the following components:

- Horizontal, height adjustable patient positioning table with floating tabletop and integrated column stand with control arm,
- Bucky with cassette tray or detector- grid unit\*,
- 3-field measuring chamber\*,
- Vertical Bucky Wall stand\*,
- X-Ray Generator,
- X-Ray tube assembly with housing\*,
- Anti-scatter Grid\*
- Collimator\*

#### **Optional components**

- Dose area product meter system\* and
- Different direct X-Ray-systems (consisting of DR-detector\* (such as RAPIXX-Series), Interface Box, and Software)
- Software CONAXX 2

#### **Optional Accessories**

The PRS 500 B can be equipped or customized with the following accessories:

- Mattress\*
- Handgrip tabletop\*
- Patient extending handle\*/\*\*
- Ceiling bracket cabeling 4m
- Wall bracket cabeling 4m
- Ceiling bracket cabeling 2m
- Wall bracket cabeling 2m
- Detector holder incl. 2 handles\*/\*\*
- STITCHING TROLLEY/\*\*

\* These components can also be used in a patient area.

\*\*Accessories with medical purpose

#### **Accessories which may affect EMC**

- Network cable (consider max. length of cable noted in the documentation of components)
- Data cable for RAPIXX connection (consider max. length of cable noted in the documentation of components)
- WLAN-Router (Use only devices approved by PROTEC)
- ...

## 1.2.2 Installation

See separate "Installation manual" PRS 500 B.

Contact information of persons which are qualified to make installations are requestable at:

PROTEC X-ray Systems GmbH  
In den Dorfwiesen 14 | 71720 Oberstenfeld  
Phone: +49 (0) 7062 – 92 55 0  
Fax: +49 (0) 7062 – 92 55 60  
E-Mail: [protec@protec-med.com](mailto:protec@protec-med.com)  
Internet: [www.protec-med.com](http://www.protec-med.com)

### 1.2.2.1 Floor capacity



#### NOTE

The X-ray system is primarily made of metal pieces. This has a main role in the weight of the device.

The X-ray system PRS 500 B has a weight of 900kg (incl. UT Generator).

Every technician is obliged to check the ground load. Also double bottoms and hollow floors have to be taken into account.

## 1.3 Product specific characteristics

### 1.3.1 Variable height radiographic table

- Variable table height (57,5 cm – 87,5cm)
- Floating tabletop
- Tabletop colour – white
- Magnetic activated tabletop brake for effortless patient positioning
- A low (optimized) distance between the tabletop surface and the film (detector) surface
- Large adjustment range of the tabletop for position of the patient
- Reliable construction
- Lateral rails of the tabletop prepared to accept a number of table accessories
- Prepared for the installation of a Bucky with anti-scatter grid and 3-field measuring chamber intended for the use with automatic exposure control
- Useable for variable cassette/detector sizes. Formats from 13 cm x 18 cm (5" x 7") to 43 cm x 43 cm (17" x 17"), depending on analog or digital use
- Column stand intended for use within rooms with a ceiling height of at least 2.5 meters
- Control elements within the control panel well placed and easy to activate
- Reproducible positioning of the X-Ray tube assembly (positions resulting from rotation around the axis of the carrying arm) through angle indicator
- Vertical range of travel of the focus height from 35 cm up to 180 cm during horizontal beam projection
- Electromagnetic brakes for the longitudinal movement of the tube column stand, the vertical movements of the carrying arm, the rotational movements of the X-Ray tube assembly around the axis of the carrying arm with integrated latching every 90° as well as the vertical movements of the thorax Bucky.
- Integrated safety connector for automatically centering the X-Ray tube assembly and the Bucky in the longitudinal direction (under-table position) or in the vertical direction (thorax position).
- Prepared for digital Bucky's

### 1.3.2 Vertical Bucky Wall Stand

- Space saving with minimal footprint
- Floor mounted wall stand
- cassette loading from the right or left side (specified at installation)
- Useable for variable cassette/detector sizes. Formats from 13 cm x 18 cm (5" x 7") to 43 cm x 43 cm (17" x 17"), depending on analog or digital use
- Prepared for digital Bucky's

### 1.4 Intended use

The general-purpose diagnostic X-ray systems of the PRS 500-series are intended for various routine applications in planar X-ray imaging in human medicine.

They are stationary systems that can be used both for analogue and digital imaging.



#### NOTE

At the acceptance test a 25mm Aluminium / 99,5% purity can be used as a phantom for a patient equivalent.

The acceptance test has to be made in accordance to the local laws and directives. Only Special trained People are allowed to do this.

---

### 1.5 Indication and Contraindication

#### 1.5.1 Indications

##### Justification of medical exposures

According to §23 of the German Radiological Ordinance (RöV), an X-ray examination is only justified if the patients benefit from x-ray diagnostics outweighs the radiation risk. The examination method, means the conventional X-ray with the PRS 500 system, must be suitable to answer the diagnostic question and no other more suitable alternative method is available.

Accordingly, it is also described by the International Atomic Energy Agency (IAEA) in the document *Radiation Protection and Safety of Radiation Sources: International Basic Safety Standards* (Requirement 37: Justification of medical exposures). It also refers to the need to consider national or international guidelines for the justification of a medical exposure.

A complete list of indications is unrealisable for conventional radiography, because the spectrum of conventional X-rays is very diverse and can vary in the course of medical-technical progress.

Some examples of indications for an X-ray examination may be:

- For the diagnosis of a bone fracture or bony injuries of the skeletal system or pathological changes of hard tissues.
- To control the bone setting.
- For the diagnosis of luxations and ligament ruptures of the locomotor system.
- For the diagnosis of degenerative, inflammatory, traumatic and tumorous diseases and changes of the locomotor system.
- For diagnostic of malformations and malalignments of the skeletal system.
- For the diagnosis of thoracic and pulmonary symptoms (thorax exposures)
- For the diagnosis of sclerotherapy.
- For the diagnosis of inflammatory and expansive processes of the mucosa, cranial bones and paranasal extension.
- For the diagnosis of the abdomen (e.g. acute abdomen, plain abdominal radiography, urethrogram, cystogram).

### 1.5.2 Contra indications

There are no absolute contraindications for conventional X-rays.

But it is not allowed to make any exposures on humans when they are not medically indicated (see *Justification of medical exposures*, chapter 1.5.1 Indication).

For pregnant women and children it is important to consider if the exposure is really necessary. It should be avoided if possible.

### 1.6 Intended user group

The radiographic system PRS 500 B is exclusively designated for use by professional who are trained, in accordance with the corresponding national regulations, in the use of diagnostic X-Ray equipment and its proper (certified) use in connection with other medical products, objects and accessories.

Suitable users could include the following: Radiologist, radiology assistants, radiology technicians, doctors and other medically trained personnel.

### 1.7 Conformity

**CE 0297**

This product is in conformity with the requirements of the European Community Medical Device Directive 93/42/EEC from 06/14/1993 including all current revision standards.

The declaration of conformity is available directly from PROTEC:

PROTEC X-ray Systems GmbH  
In den Dorfwiesen 14 | 71720 Oberstenfeld  
Phone: +49 (0) 7062 – 92 55 0  
Fax: +49 (0) 7062 – 92 55 60  
E-Mail: [protec@protec-med.com](mailto:protec@protec-med.com)  
Internet: [www.protec-med.com](http://www.protec-med.com)

## 2 Safety Instructions

---

**NOTE**

Contains information that are relevant to the usage.

xxx

---

**CAUTION!**

Contains information that can cause damage to properties at non conformity.

xxx

---

**WARNING!**

Contains information that can cause personal injuries at nonconformity.

xxx

---

**WARNING!**

Warning of radioactive substances or ionising rays. Contains information that can cause personal injuries at non conformity.

xxx

---

Adjustments and calibrations that are described within the user manual must be made, with the aid of The technical description for the system, by the **PROTEC X-ray Systems GmbH** customer service department or a PROTEC X-ray Systems GmbH authorized service technician.

---

**NOTE**

Every delivered manual must be read and the safety notes have to be observed.

---

**NOTE**

After installation the commissioning must be recorded with the PROTEC acceptance protocol.

---

**NOTE**

For the digital system implementation, the manuals of CONAXX and RAPIXX must be read, and the containing safety note must be observed.

---

**NOTE**

The commissioning of the X-ray system can only be done if all safety notes and user securities have been met. The user securities can be: door contact, marked area, dosimeter, safety clothing ...

---

**CAUTION!**

**The manual contains every safety relevant information's for the commissioning of the system. Operating the device is exclusively for special trained staff. In this context there are on every operating element relevant safety symbols. Further information's are on the delivered document-CD. Those information's count as additional information's and have to be observed.**

---

**NOTE**

Every operating element is marked on the operating console and on the swivel arm or wall column, there are further descriptions for the symbols in the corresponding manual. The lawfully requirements for building regulations for X-ray systems have to be fulfilled. The X-ray system has to be checked according to the local law and also accepted by the responsible office.

---

**CAUTION!**

**If the wrong SID is in use for exposures, personal injuries for the patient can be the result. The inverse square law takes place here. Halving the distance will cause a 4 time higher radiation dose.**

---

**WARNING!**

**It's not allowed to make any medical not indicated exposures on people. At pregnancy or children the question is if the exposure is really necessary. If possible it's better to abandon it.**

---

## 2.1 General safety notice

### 2.1.1 Requirements for operation

---



#### **WARNING!**

##### **Class I ME device**

**To reduce the risk of electric shock, this unit is designated exclusively for connection to a supply network with protective earth.**

**The power for the components of radiographic system PRS 500 B is designated to be exclusively supplied through a direct connection to the available X-Ray generator. The X-Ray generator is required to offer a minimum of two connection ports with 230V 50/60Hz.**

**The X-ray Generator of the System is directly connected to the power supply (see technical description of the Generator)**

**The radiographic system PRS 500 B with stand is am ME Class I product.**

**This device contains no on/off switch. The PRS 500 B is directly connected to the X-Ray generator and is switched on/off through the switching on and off of the generator itself. In order to disconnect the PRS 500 B from the power the connected X-Ray generator must be shut off.**

---

### 2.1.2 Operating of the radiographic system

When having troubles with operating the X-ray system PRS 500 B, immediately call the Service of PROTEC or an authorized service and stop the using of the system.

#### 2.1.2.1 Operating type

The PRS 500 B is not designate for continuous use.

### 2.1.3 Operating personnel

The radiographic system PRS 500 B with stand should only be operated by personnel who are trained in accordance with the corresponding national regulations in the use and operation of diagnostic X-Ray systems.

---



#### **NOTE**

Only properly trained and authorized personnel are allowed to work with the radiographic system.

---

The user, as well as the service personnel, must pay attention to the warnings, notices and safety instructions located on the device and in the user manual. Failure to comply with the information provided can lead to injury.

---



#### **NOTE**

Operating personnel are required to acquaint themselves with all warnings (warning signs) located on the device. They serve to ensure the safety of the operator as well as others and set a basic for orderly operation.

---

## 2.1.4 Pinching and Collision Hazards

---



### CAUTION!

Ensure that while using any product that can be lowered, raised or moved in different directions, neither yourself (operator), the patient or any third party finds themselves in a hazardous position (area of movement). Remove all objects (e.g. chairs, pushcarts) from known collision areas.

Be aware that careless or improper adjustment of the radiographic system (movement of column, detector Bucky, Vertical Bucky wall stand and table top) can lead to damage of the X-Ray components, unusable X-Ray images and injury to the patient. Failure to pay attention can lead to damage of the radiographic system as well as external objects.

---



### NOTE

The PRS 500 B X-ray system has various safety functions that prevent collisions with objects, operators and patients.

---

## 2.1.5 Explosion protection

This radiographic system is not designated for use within areas with explosive hazards.

## 2.1.6 Radiation protection

X-Ray radiation can pose a hazard to patients and other people when the regulations regarding the operation of X-Ray systems are not followed.

For this reason, the basic principles of radiation protection are of the highest priority and must be followed without exception:

- **Distance from the radiation source**  
The dosage is reduced as a factor of the square of the distance from a (dot shaped) radiation source. Double the distance  $\frac{1}{4}$  dose, triple the distance  $\frac{1}{9}$  dose
- **Keep the exposure time as short as possible**  
The dosage is directly correlated with the exposure time. A half exposure time results in a radiation dose half that of a full exposure. (This is especially pertinent with fluoroscopy, as X-Ray images have predetermined mAs).
- **Utilize shielding and protective clothing**  
The protective value grows exponentially with the thickness of the shielding. Two half-value layer thickness (HVL) weaken (homogeneous) radiation to  $\frac{1}{4}$ , 3 HVL to  $\frac{1}{8}$ , and 10 HVL to less than  $\frac{1}{1000}$  of the original value.
- **Do not reach into the direct X-Ray beam**  
The dosage in a un-weakened-Ray beam is around 100 times larger than that in the scattered radiation.
- **Use personal dosage meters in working with radiation (X-Rays), the use of personal dosage monitors is suggested.**

The X-Ray images are principally triggered from behind a protective wall. For the creation of images near the reproductive organs use the maximum available protection (e.g. testicular shielding or lead covers)

People that must remain close to the patient are required to wear protective clothing (e.g. lead apron). This counts for maintenance and installation work as well.

## 2.1.7 Ventilation

It is important to ensure that the air exchange of the X-Ray generator within the system is not hindered. The ambient air temperature is not allowed to exceed 40°C.

## 2.1.8 Interaction with external devices

Unwanted interaction with external devices is not known.

---

## 2.1.9 Electromagnetic Environment and the influence of devices

---



### CAUTION!

**The usage of other accessories, converter and other cables besides the delivered ones or by PROTEC (or the component manufacturer) established ones can cause increased electromagnetic emissions or a decreased electromagnetic resistance, which will lead to an improper operating mode.**

---



### CAUTION!

**The usage of PRS 500 B straight next to other devices or stacked devices should be avoided, since it can cause an improper operating mode. If there is no other possibility than this the PRS 500 B and other devices should be studied to make sure they work proper.**

---



### NOTE

The characteristics of this device, as determined by emissions, allow its use in the industrial sector and in animal clinics (CISPR, Class A). When used in residential areas (for which Class B is usually required by CISPR 11), this unit may not provide adequate protection for radio services. The user must take remedial measures such as implementation or reorientation of the device.

---

The PRS 500 B is intended for the usage in a professional environment of the medical service (e.g. clinic, surgery centers, physiology offices ...)

### 3 Control elements and device displays

#### 3.1 Control elements and device displays Basic X-ray system table

Detailed information please find in the enclosed User Manual of the PROGNOST B.

#### 3.2 Control elements and device displays collimator

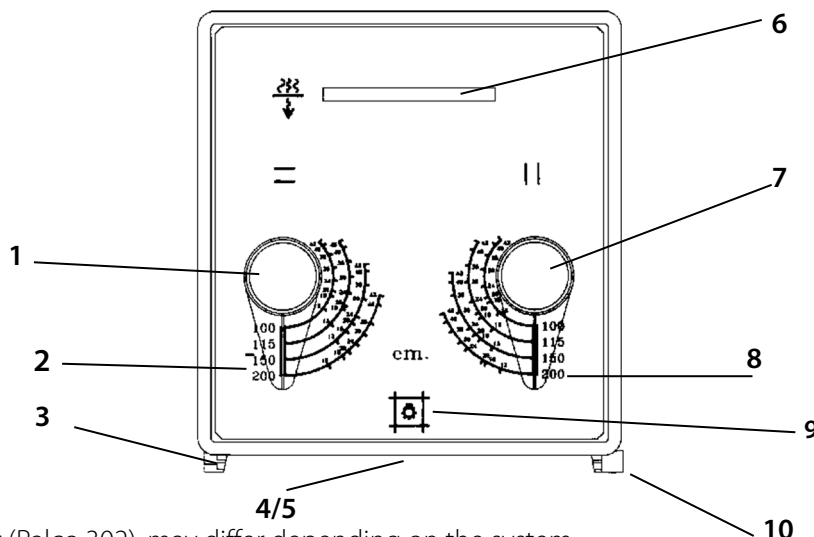

Figure collimator (Ralco 302), may differ depending on the system.

**Pos. 1** -> Collimator adjustment control; allows for manual opening and closing of collimator shutters (transversely to table top).

**Pos. 2** -> Scales; indicate the opening of collimator shutters (transversely to table top).

**Pos. 3** -> Accessory rails (can be used for measuring phantoms).

**Pos. 4** -> Light resp. X-ray field; corresponding to opening of collimator shutters.

**Pos. 5** -> Light centering device; allows centering of the X-ray tube assembly with the bucky unit.

**Pos. 6** -> Filter control for selection of additional filtration.

**Pos. 7** -> Collimator adjustment control; allows for manual opening and closing of collimator shutter (longitudinally to table top).

**Pos. 8** -> Scales; indicate the opening of collimator shutters (longitudinally to table top).

**Pos. 9** -> Collimator light switch; turns on collimator light.

**Pos. 10** -> Measuring tape.

Detailed information please find in the enclosed User Manual collimator.

#### 3.3 Control elements and device displays of X-ray tube

Detailed information please find in the enclosed User Manual of the X-ray tube.

#### 3.4 Control elements and device displays of X-ray generator

Detailed information please find in the enclosed User Manual of the X-ray generator.

#### 3.5 Control elements of Bucky, Grid entity

Detailed information please find in the enclosed User Manual.

#### 3.6 Control elements and device displays of vertical wall stand

Detailed information please find in the enclosed User Manual of the PROGNOST B.

#### 3.7 Control elements and device displays of RAPIXX system

Detailed information please find in the enclosed User Manual of the RAPIXX system.

#### 3.8 Control elements and device displays of CONAXX 2

Detailed information please find in the enclosed User Manual of the CONAXX 2.

### 3.8.1 CONAXX 2 status messages on the touch PC







= Error message















= Warning message



= Information message

CODE	MESSAGE	DESCRIPTION	SOLUTION
	E01: Abnormal Sensor for WS Bucky	The electrical signal value of the potentiometer does not change during the movement	Please contact the authorized service provider.
	E02: Abnormal Sensor for Table Bucky	The electrical signal value of the potentiometer does not change during the movement	Please contact the authorized service provider.
	E03: Abnormal Sensor for Lifting Table	The electrical signal value of the potentiometer does not change during the movement	Please contact the authorized service provider.
	E04: Abnormal Sensor for Tube Column	The electrical signal value of the potentiometer does not change during the movement	Please contact the authorized service provider.
	E05: The actual direction of the movement of the tube is reversed	The actual movement of the tube arm is in opposite direction as intended	Immediately press one of the emergency stop buttons and then unlock it again. Please contact the authorized service provider.
	E06: Out of SID tracking range	The SID distance between tube and table Bucky during autotracking is abnormal	Please check SID before exposure. Message is for informational purposes only. All functions still available.
	E11: No position calibration for WS Bucky	The wallstand Bucky position is not calibrated	Please contact the authorized service provider.
	E12: No position calibration for Table Bucky	The table Bucky position is not calibrated	Please contact the authorized service provider.
	E13: No height calibration for Table	The table height is not calibrated	Please contact the authorized service provider.
	E14: No position calibration for Rail Carriage	The rail carriage position is not calibrated	Please contact the authorized service provider.
	E15: No height calibration for Tube	The tube height is not calibrated	Please contact the authorized service provider.
	E16: No angle calibration for Tube	The tube angle is not calibrated	Please contact the authorized service provider.
	WS upper Limit	The wallstand Bucky reaches the upper software limit or hardware switch	Information only. Check whether the position is desired and the exposure can be carried out.

	WS lower Limit	The wallstand Bucky reaches the lower software limit or hardware switch	Information only. Check whether the position is desired and the exposure can be carried out.
	Left Limit for Table Bucky	The table Bucky reaches the left software limit or hardware switch	Information only. Check whether the position is desired and the exposure can be carried out.
	Right Limit for Table Bucky	The table Bucky reaches the right software limit or hardware switch	Information only. Check whether the position is desired and the exposure can be carried out.
	Upper Limit for Table	The table reaches the upper software limit or hardware switch	Information only. Check whether the position is desired and the exposure can be carried out.
	Lower Limit for Table	The table reaches the lower software limit or hardware switch	Information only. Check whether the position is desired and the exposure can be carried out.
	Tube Upper Limit	The tube reaches the upper software limit or hardware switch	Information only. Check whether the position is desired and the exposure can be carried out.
	Tube Lower Limit	The tube reaches the lower software limit or hardware switch	Information only. Check whether the position is desired and the exposure can be carried out.
	Bull collision protection	The anti-collision sensor on the back of the Touch PC detects an object in the immediate vicinity	Check whether an object or patient is in the immediate vicinity and correct the position of the tube arm or table accordingly.
	Out of the Tracking Range	The autotracking position of the tube is out of range for the wallstand Bucky or the table Bucky	The centring of the exposure position wallstand or table Bucky to the tube must be corrected.
	Reach Min Safety Distance	The minimum safety distance between tube and table top is reached	Note for users. Check whether the position of the tube or table is as desired.
	Connecting to CONAXX...	Establishing connection between CONAXX touch PC and CONAXX desktop PC	Wait. If unsuccessful after 5 minutes, restart the system according to the switch-on order.
	Connecting to PRS 500 B...	Establishing connection between CONAXX touch PC and system	Wait. If unsuccessful after 5 minutes, restart the system according to the switch-on order.
	Connection failed	Connection between the system and the CONAXX PC failed	Restart the system according to the switch-on order. If the error persists, contact the authorized service provider.

## 4 Handling / Operation

### 4.1 Operation with the radiographic system

---



#### WARNING!

**It must be ensured that when making exposures on the wallstand, the X-ray tube is always rotated towards the wall first.**

**When making exposures at the X-ray system table, the X-ray tube must always be rotated towards the table first.**

---

#### 4.1.1 Operation at the X-ray table

---



#### NOTE

The PRS 500 B system has a minimum safety distance between the X-ray tube assembly and the X-ray system table, which prevents body parts or objects from being pinched.

---



#### NOTE

The motorisation of the X-ray arm of the PRS 500 B is developed in such a way that if unexpected resistance occurs from objects, the motorised movement immediately switches to idle and only minimal forces are applied.

---

#### 4.1.1.1 Releasing the tabletop brake and positioning the tabletop

---



#### NOTE

Prior to patient positioning, the X-ray unit must be brought into the required exposure position.

---



#### WARNING!

**The tabletop may only be locked when the tabletop is in the rest position, not while it is being moved.**

---

1. Release the tabletop brakes by double-clicking on one of the two-foot switches.
2. Move the floating tabletop to the desired position by hand while keeping the foot switch pressed.
3. When the tabletop is in the rest position, release the foot switch and the tabletop will be locked again by the brakes.

#### 4.1.1.2 Position of patients on the tabletop

- Adjust the height of the tabletop so the patient can mount it easily
- Placing patient on table top and leaving table top
  - Center the tabletop as much as possible (back/front).
  - The patient should take place in the middle of the tabletop and also leave at this position.

#### 4.1.1.3 Setting the X-ray unit to the mid of movable Bucky, Grid entity

- Move the tube column to a position in between the limits of the traveling range of the table Bucky, Press the button for auto tracking on the touch display (see user manual for PROGNOST B)

- The tube moves to the defined height, the table moves to the defined height and the Bucky travels to the position where center beam is aligned to Bucky center. The SID is also set to the standard height and will not be changed.
- Now if you move the tube column the Bucky follows the tube position, as long both are in the limits of the Bucky travel, otherwise an error message appears on the TOUCH-PC: "Out of tracking range". If you move the tube back into the travel range the message disappears and the Bucky follows again.

#### 4.1.1.4 Inserting an image receptor into the cassette tray

- An image receptor may be placed into the cassette tray, when the X-ray tube assembly is positioned (see item 4.1.1.3).
- Pull out the cassette tray by its handle from the bucky unit until it hits the forward stop.
- The image receptor clamps centre the image receptor transversely within the cassette tray. Rotate its latch counter clockwise to unlock it.
- Open the image receptor clamps far enough to insert an image receptor of the desired size.
- At table bucky insert the image receptor, with its transverse centerline aligned with the notch in the image receptor clamps or by engaging the image receptor positioner in the size of the image receptor corresponding detent (13 cm, 18 cm, 24 cm, 30 cm, 35 cm, 40 cm or 43 cm), push the image receptor to the image receptor positioner.
- Push the image receptor clamps against the image receptor and rotate the latch into the locked position.
- Push the cassette tray fully into the bucky unit.

#### 4.1.1.5 Adjusting the source to image-detector distance (SID)

- Set the X-ray unit with a tape measure at the collimator or the display on the tube to the desired source to image-detector distance (SID).
- *Manual mode:* You can adjust the SID by moving the tube column up or down by pressing the corresponding button on the tube head (Detailed description, see user manual PROGNOST B).
- *Auto tracking mode:* The SID is fixed by the system. You can only move the table height. The tube height will follow and the movement stops at the pre-defined SID.

#### 4.1.1.6 Adjusting the light resp. X-ray field

- Press the collimator light switch (button 9, figure collimator) to turn on the collimator light, and view the opening of the collimator shutter in both axes relative to the image receptor size scales.
- Several SID scale (adjuster 1 and 7, figure collimator) are provided to indicate the correct settings of the collimator adjustment controls for the collimator shutters for several image receptor sizes so that the light beam and the X-ray field can be limited to the desired image receptor size in both axes. Adjust image receptor size as required using the collimator adjustment controls. Reduce shutter openings to objects size for better image quality.



#### NOTE

The system accuracy of the automatic, motorized centring can show minimal deviations to the centre of the image receptor. This effect increases with increasing SID.

---

#### 4.1.1.7 Exposure preparation / exposure release

- At the X-ray generator operator console control panel, select the desired X-ray equipment (bucky table with bucky unit) by selecting the corresponding X-ray equipment/exposure technique switch.
- Press the desired Anatomically Programmed Radiography (APR) switch or manually select the desired exposure factors. Start the exposure by pressing the switches for exposure preparation/exposure release.

#### 4.1.1.8 On table exposures

- Place an image receptor to the desired position on the table top.
- Move X-ray tube to the desired position and adjust SID.
- Press the collimator light switch (button 9, figure collimator) to turn on the collimator light, and view the opening of the collimator shutters in both axes relative to the image receptor size scale.
- Place object on image receptor.
- Adjust the light field with the adjuster 1 and 7 (figure Collimator) onto the size of the used image receptor. So the radiation field will be limited to the size of the image receptor.
- At the X-ray generator operator console control panel, select the desired X-ray equipment (bucky table without bucky unit) by selecting the corresponding X-ray equipment/exposure technique switch.
- Press the desired Anatomically Programmed Radiography (APR) witch or manually select the desired exposure factors. Start the exposure by pressing the switches for exposure preparation and exposure release.

#### 4.1.1.9 Exposures with the lateral detector holder (optional)

- **1. Step:** Move the tube down beside the table



- **2. Step:** Press the foot pedal on the tube column wagon to rotate the whole tube column to the left or right side

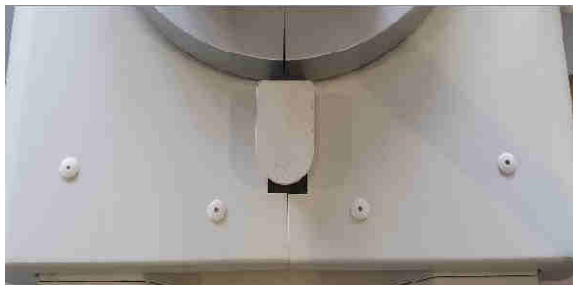

- **3. Step:** Turn the tube head in direction of the lateral detector holder



- **4. Step:** Push the tube column to the lateral detector holder



- **5. Step:** Adjust the height of the tube arm or of the table that the light field is aligned to the panel

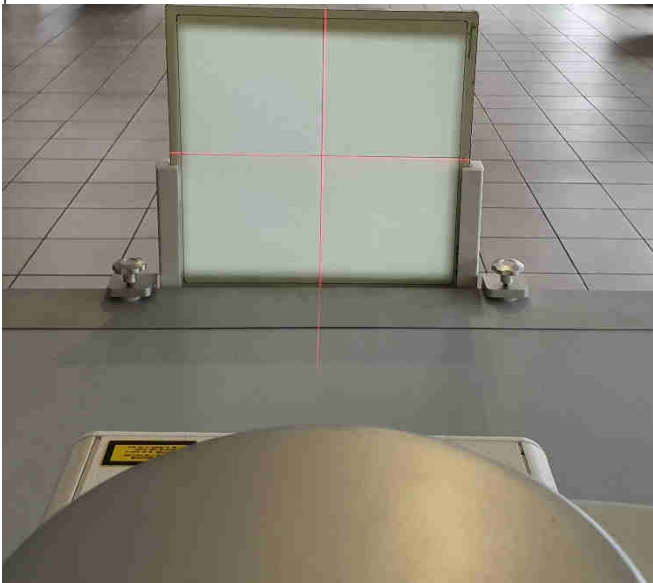

**NOTE**

Because of the protection functions of the PRS 500 B it is only possible to move the tube down **beside** the table to reach the panel height in the lateral detector holder. If the tube moves too high within the alignment it is **not** possible to move the tube back down.

In this case the whole tube column must be pushed beside the table and the tube must be moved down again.

**4.1.2 Operation at vertical wall stand****4.1.2.1 Anti-collision sensor**

The anti-collision sensor is an infrared sensor. It isn't sensitive to dark subjects, but very sensitive to bright surfaces. It is **only** suitable for detecting and anti-colliding with the table top. The distance between the sensor and the table top is measured internally by this sensor and a signal is released when the distance is shorter than the previous detecting distance adjustment.

**4.1.2.2 Adjustment of the X-ray unit to the mid of a cassette or Bucky/Grid entity of a X-ray table (horizontal center beam)**

- By pressing the button for rotation on the tube head, the brake for the rotation will be released.
- Turn the X-ray unit to the wall stand.
- Set the Bucky/Grid entity on the vertical stand to the desired height for the patient.

**4.1.2.3 Adjustment of the source to image-receptor distance (SID)****NOTE**

The display shows the correct SID only when making orthogonal exposures on table or on wall stand. If you make exposures beside the table top or oblique exposures the displayed value is not correct. You have to measure the SID with an analogue measuring device.

- Release the brake for the longitudinal movement of the column by pressing the button for horizontal brake. Adjust the necessary film focus distance (SID) which will be used for the exposure. The current SID distance you is shown on the display.

**4.1.2.4 Adjustment of the light-/ radiation field**

- By using button 4 (figure control handle) the button of the brake for adjusting the height will be released
- Set the collimator to the requested height and align it to the Bucky by using the light-beam localizer 4 (figure control handle).

- Release Button 4 (figure control handle) to activate the height-adjustable brake for the collimator.
- By using button 9 (figure collimator) the light-beam will be activated to control the vent of the collimator to the used cassette.
- With the adjuster 1 and 7 (figure collimator) set the lamellas of the collimator to the size of the used cassette. The settings will be done on the scale 2 and 8 (figure collimator) to the according cassette source to image-receptor distance (SID). So the light-/ radiation field is limited to the according cassette.

Detailed information please find in the enclosed User Manual of the PROGNOST B.

**NOTE**

The system accuracy of the automatic, motorized centring can show minimal deviations to the centre of the image receptor. This effect increases with increasing SID.

**NOTE**

The automatic, motorized centring of the system focuses on the centre of the image receptor and not on the surface of the bucky cover. For this reason, the centring of the collimator (e.g. laser) does not correspond to the centre of the image receptor for oblique exposures.

#### 4.1.2.5 Exposure preparation/ release

- Select the used device on the console of the generator (vertical-grid recording device).
- Select the requested organ program or the requested exposure details, and start the exposure by using the control element for exposure preparation/ release.

#### 4.1.3 Operation collimator

Detailed information please find in the enclosed User Manual of the collimator.

#### 4.1.4 Operation X-ray Tube

**NOTE**

The X-Ray tube needs to be warmed-up daily in order to extend the life of the tube and prevent tube arcs (Especially when the X-Ray tube was not used for a long period). The seasoning procedure shall be done upon turning on the generator for the first time.

Follow X-Ray tube manufacturer's recommended seasoning procedure.

If X-Ray tube manufacturer's seasoning is not available, then use the following procedure:

Set Generator: Large focal spot, 200mA, 40mAs

Take 8 exposures starting at 50 kV and increment the kV steps of 10 kV up to 120 kV (Exposure every 30 seconds, otherwise tube may arc).

See User Manual of the generator and CONAXX 2 User Manual 5.3.

---

Detailed information please find in the enclosed User Manual of the X-ray tube.

### 4.2 Operation X-ray generator

Detailed information please find in the enclosed User Manual of the generator.

### **4.3 Operation Bucky, Grid entity**

Detailed information please find in the enclosed User Manual.

### **4.4 Operation RAPIXX system**

Detailed information please find in the enclosed User Manual.

### **4.5 Operation Software**

Detailed information please find in the enclosed installation- and User Manual CONAXX 2.

## 4.6 Function of the PRS 500 B

### 4.6.1 Switching on the PRS 500 B

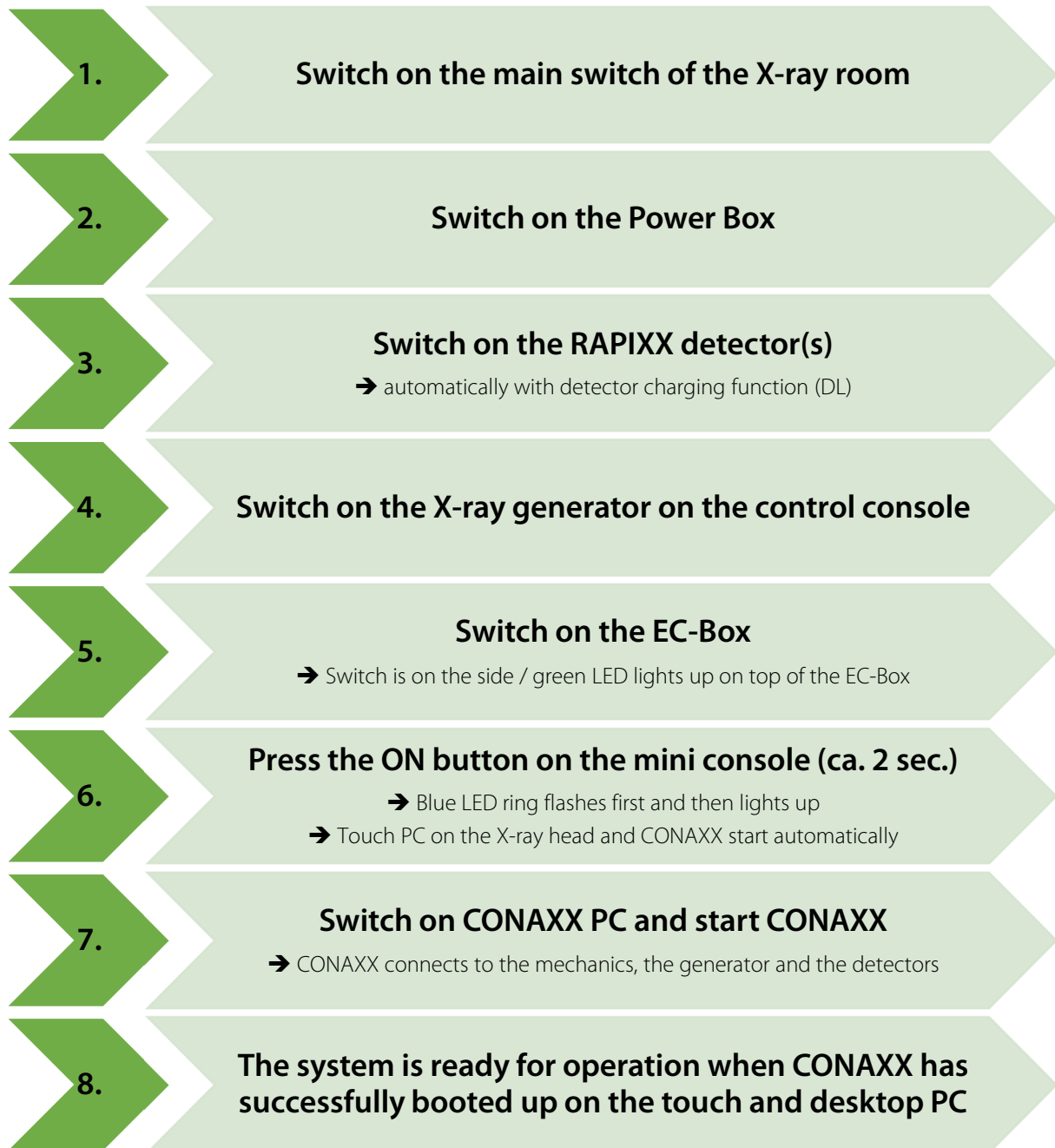

## 4.6.2 Switching off the PRS 500 B



### CAUTION!

Before switching off the PRS 500 B system ensure that the tube head is turned to 0° to avoid accidentally turning movements and damages of the tube head.

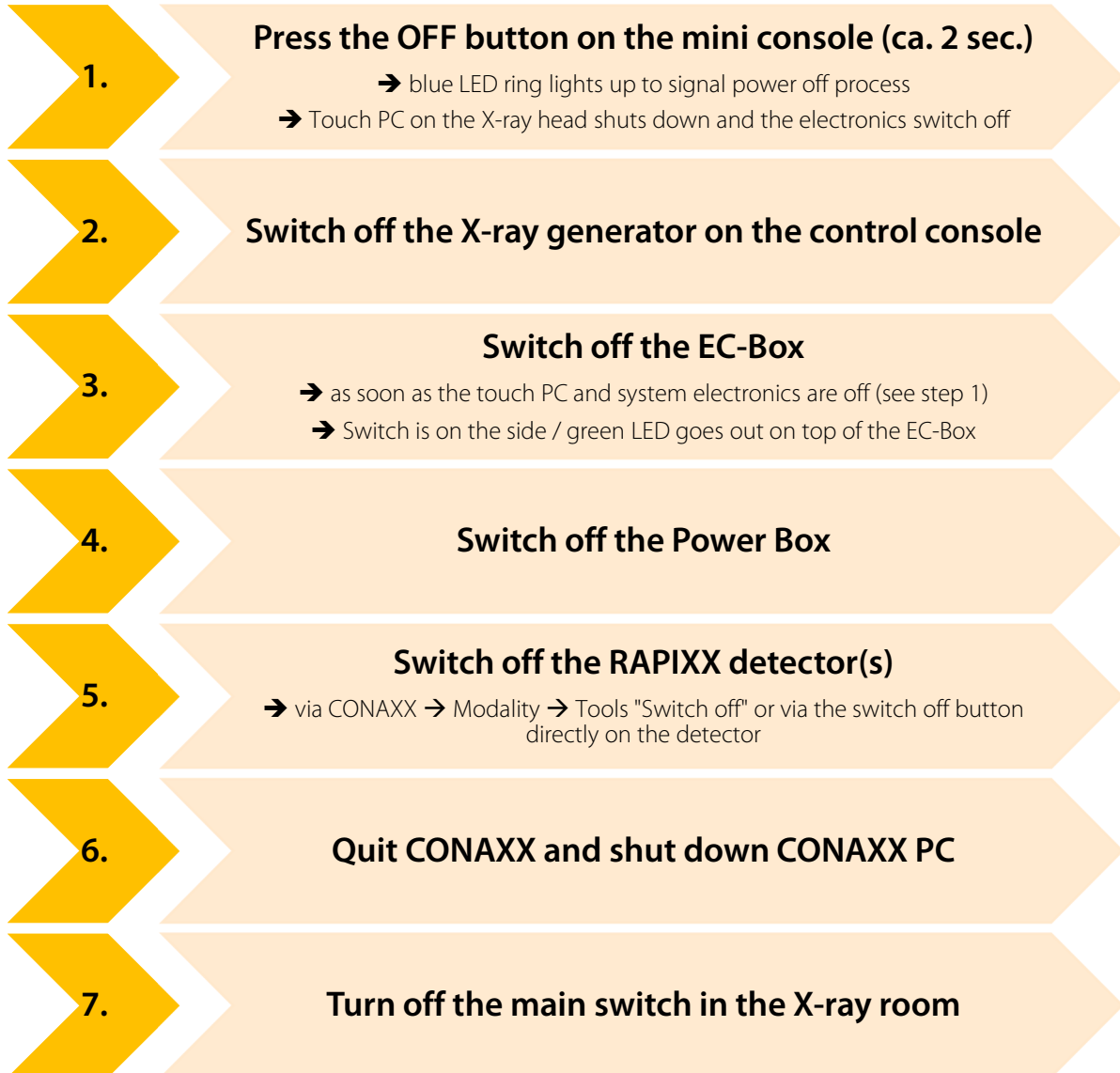

### NOTE

To perform a regular shutdown of the touch PC it is necessary that the CONAXX software is running on the desktop PC and on the touch PC at the same time while the OFF button on the mini console is pressed. If one component is not working, there is no communication between both parts and the system cannot shut down properly.

If CONAXX is closed on the touch PC or desktop PC before the system is turned off properly using the OFF button on the mini console, the system can be turned off using a "hard shutdown". To do this, press the OFF button on the mini console for at least 5 seconds to interrupt the power supply to the system.

#### **4.7 Exposure automatic**

If the PRS 500 B is operated with an exposure automatic the functionality can be checked like this: Place a Phantom or any other weakening object in the radiation way. Choose a measuring chamber and expose. If this happens properly the measured value will be displayed. If something is not running properly an Error message will be shown. Repeat this procedure for every measuring chamber.

## 5 Safety and Maintenance

---



### WARNING!

#### Caution Electrocutation hazard!

**Prior to cleaning or disinfection, switch of the X-Ray generator. As a result, the radiographic system will be disconnected from power and the danger of electric shock is eliminated.**

---

### 5.1 Introduction

In this chapter, you will find details regarding safety and maintenance, which is required to ensure the correct and reliable function of the radiographic system following initial installation.

### 5.2 Cleaning and disinfection

---



#### NOTE

Caution  
Changes to material are possible!

---

Pay attention that, during cleaning and/ or disinfection, no fluids find their way into the main housing of the radiographic table. This reduces the risk of short circuits and corrosion.

---



#### NOTE

At a X-ray system with RAPIXX implementation please see the attached RAPIXX manual, chapter 8.2 for detailed information's for cleaning and disinfections.

---

#### 5.2.1 Cleaning

The use of corrosive or abrasive cleaning agents as well as solvents is not allowed. These materials can cause damage to the outer surface of the unit or to the coating of the individual components.

Clean the outer surfaces of the unit and all painted components using a damp towel and a mild – light alkaline cleaning agent (e.g. RBS\* Neutral T). Dry the components off following cleaning.

Chrome components should be cleaned by being wiped down with a dry woolen cloth

#### 5.2.2 Disinfection

Disinfection must be performed in accordance with the applicable legal requirements and guidelines corresponding to disinfection and explosion protection.

For reasons related to safety, the use of spray disinfection is not allowed. The mist from such disinfection dispenser systems can find its way into the unit, resulting in short circuiting and/ or corrosive build up.

All components within the radiographic system, including unit accessories, should undergo a wipe down disinfection using appropriate surface disinfection agents (e.g. Melsept\* SF, 15 min. reaction time with a concentration of 2%). The information provided by the disinfectant manufacturer in regard to concentration and reaction time must be closely followed.

No disinfection agent, which is classified as flammable, can be utilized.

Should explosive gas and / or vapors be created through the use of the chosen disinfection agents, the unit can only be switched on when the gas/vapors have 100% disappeared.

---

### 5.3 Check-up and maintenance

---



#### **WARNING!**

It's forbidden to make any checkup or maintenance services while the **PRS 500 B** is in use with a patient! Any checkup or maintenance services can only be done by people who got trained or authorized by PROTEC.

---

#### **5.3.1 Daily Controls (prior to or during the unit operation)**

See User Manual off all integral components.

Only original spare parts are to be used in situations requiring component replacement.

#### **5.3.2 Regular controls**

See User Manual off all integral components.

#### **5.3.3 Maintenance**

---



#### **NOTE**

Only original spare parts are to be used in situations requiring component replacement Maintenance

---

Required maintenance must be performed at 12-month intervals by PROTEC Service or specific authorized service provider to ensure the reliable operation of the equipment.

In the event that scheduled maintenance is not performed, PROTEC X-ray Systems GmbH will not be responsible for damages incurred by the user or third parties if such damages are the result of improper or omitted maintenance.

Prior to operation (creation of X-Ray images), the operator must ensure that all Safety related mechanisms, indicators and/or switches described within the user manual are fully functional and that the unit is overall operationally ready.

See Technical Description off the system and off all integral components.

Only original spare parts are to be used in situations requiring component replacement.

#### **5.3.4 Warranty**

---



#### **NOTE**

The current conditions of guarantee are deposited in the order papers or in the valid pricelist to the time of purchase.

---

All repairs and replacement of components because of misuse and/or incorrect operation are excluded from the warranty.

PROTEC service department of PROTEC authorized technicians may only do service and maintenance work.

#### **5.3.5 Product life time**

The PRS 500 B has an expected product life of 10 years when used in accordance with the product specifications/ limitations and provided that maintenance through the PROTEC service department or a **PROTEC** authorized service provider has be completed. After reaching the life span the further usage of the device happens on own risk.

#### **5.3.6 Further Information**

Further information's to the chapters and for a safe usage, transport or storage are in the technical description of the system and of the individual components

### 5.3.7 Applied Parts and parts which get handled like an application part

Part	Definition (as applied part or parts which get handled like an applied part but not defined as applied part)
Table top	Applied part
Cover – vertical wall stand	Applied part
Detector	Applied part
Housing parts PROGNOST B	Part, get handled like an applied part
<b>Optional accessory</b>	
Patient extending handle ( <i>optional</i> , mounted at the vertical wall stand)	Part, get handled like an applied part
Mattress ( <b>optional</b> )	Part, get handled like an applied part

### 5.3.8 Disposal



The X-ray system PRS 500 B contains different plastics and oils. At disposal of exchange parts or the whole system the current regulations have to be observed. Please contact your contractual partner or the service company, or a company specialized for disposing the components.

## 6 Electrical data



### NOTE

The X-ray system is in need of the following power supply (see table „Power supply Generator).

Type generator	<b>PROVARIO HF 50</b>	<b>PROVARIO HF 60</b>	<b>PROVARIO HF 80</b>
Output Power	50kW	65kW	80kW
Power supply voltage	400V AC		
Phase	3PH-N-PE		
Power frequency	50/60 Hz		
Electrical resistance per phase	0,3Ω	0,2Ω	0,12Ω
Fuse	50A		

List (Power supply generator)

Type generator	<b>Venus 50R, 3 phase</b>	<b>Venus 50R, 1 phase</b>	<b>Venus 32R, 3 phase</b>	<b>Venus 32R, 1 phase</b>
Output Power	50kW	50kW	32kW	32kW
Power supply voltage	380V AC/400V AC	220V AC	380V AC / 400V AC	220V AC/230V AC
Phase	3PH-N-PE	1phase	3PH-N-PE	1phase
Power frequency	50/60Hz	50/60Hz	50/60 Hz	50/60 Hz
Electrical resistance per phase	0,15 Ω/0,17 Ω	0,5Ω	0,27 Ω/0,29 Ω	0,5Ω
Fuse	63A	16A	63A	16A

List (Power supply generator)

Type generator	<b>CMP 200 DR 50</b>	<b>CMP 200 DR 60</b>	<b>CMP 200 DR 80</b>
Output Power	50kW	65kW	80kW
Power supply voltage	400/480 V AC only		
Phase	3PH-N-PE		
Power frequency	50/60 Hz		
Electrical resistance per phase	0,17Ω/0,24Ω	0,13Ω/0,19Ω	0,10 Ω/0,15Ω
Fuse	60A/480V		

List (Power supply generator)

Type generator	<b>RFX 50</b>	<b>RFX 60</b>	<b>RFX 80</b>
Output Power	55kW	65kW	80kW
Power supply voltage	380V/400V/440V/480V		
Phase	3PH-PE (N not needed)		
Power frequency	50/60 Hz		
Electrical resistance per phase	0,15Ω 0,17Ω 0,20Ω 0,24Ω	0,15Ω 0,17Ω 0,20Ω 0,24Ω	0,10Ω 0,11Ω 0,14Ω 0,16Ω
Fuse	50A/480V		

List (Power supply generator)

**WARNING!**

To lower the risk of an electrical shock, the device can only be run on a power supply with a protective conductor.

## 6.1 Electromagnetic Compatibility (EMC) after EN 60601-1-2

**CAUTION!**

The radiographic system PRS 500 B is, as a medical electrical electric device, subject to particular precautionary measures in regard to EMC and is required to be installed and prepared for initial use as described within the accompanying documents.

**CAUTION!**

Mobile HF-Communication devices shouldn't be used closer than 30cm (12 Inch) to the marked parts and cables of the PRS 500 B. Disregarding this can cause a decrease in the performance features of the device.

**CAUTION!**

The X-Ray generator integrated into the radiographic system PRS 500 B sends out electromagnetic waves during operation, which could cause interference with other devices.

For EMC guidelines and manufacturers declaration for the generator according to EN 60601-1-2, see the separate User Manual for the corresponding generator.

### 6.1.1 Guidelines and Manufacturers declaration – electromagnetic interference (non-life supporting device)

The radiographic system PRS 500 B is intended for use in the electromagnetic environment specified below. The customer or the user of the radiographic system should assure that it is used in such an environment.

Emissions test	Compliance	Electromagnetic Environment
RF emissions CISPR 11	Group 1	This radiographic system uses RF energy only for its internal function. Therefore, the RF emission is very low and unlikely to cause any interference in nearby electronic equipment.
RF emissions CISPR 11	Class A	This radiographic system is suitable for use in all establishments other than domestic, and may be used in domestic establishments and those directly connected to the public low-voltage power supply network that supplies buildings used for domestic purposes, provided the following warning is heeded: <b>Warning:</b> This system is intended for use by healthcare professionals only. This equipment/system may cause radio interference or may disrupt the operation of nearby equipment. It may be necessary to take mitigation measures, such as re-orienting or relocating the radiographic system or shielding the location.
Harmonic emissions EN 61000-3-2	Class A	
Voltage fluctuation/ flicker Emission EN 61000-3-3	Complies	

The radiographic system PRS 500 B is intended for use in the electromagnetic environment specified below. The customer or the user of the radiographic system should assure that it is used in such an environment.

Immunity Test	EN 60601-1-2 Test level	Compliance level	Electromagnetic Environment - guidance
Electrostatic discharge (ESD) EN 61000-4-2	± 6 kV contact ± 8 kV air	EN 60601-1-2 Test level	Floors should be wood, concrete or ceramic tile. If floors are covered with synthetic material, the relative humidity should be at least 30%.
Electrical fast transient/burst EN 61000-4-4	± 2 kV for power supply lines  ± 1 kV for input/output	EN 60601-1-2 Test level	Mains power quality should be that of a typical commercial or hospital environment.
Surge EN 61000-4-5	± 1 kV differential mode  ± 2 kV common mode	EN 60601-1-2 Test level	Mains power quality should be that of a typical commercial or hospital environment.
Voltage dips, short interruptions and voltage variations on power supply input lines EN 61000-4-11	<5 % $U_T$ for 0,5 cycle (>95 % dip in $U_T$ ) 40 % $U_T$ for 5 cycles (60 % dip in $U_T$ ) 70 % $U_T$ for 25 cycles (30 % dip in $U_T$ ) <5 % $U_T$ for 5 s (>95 % dip in $U_T$ )	EN 60601-1-2 Test level	Mains power quality should be that of a typical commercial or hospital environment. If the user of the radiographic system requires continued operation during power mains interruptions, it is recommended that the radiographic system be powered from an uninterruptible power supply or a battery.
Power frequency (50/60 Hz) magnetic field EN 61000-4-8	3 A/m	EN 60601-1-2 Test level	Power frequency magnetic fields should be at levels characteristic of a  Typical location in a typical commercial or hospital environment.

NOTE:  $U_T$  is the alternating supply voltage prior to application of the test levels

Immunity Test	EN 60601-1-2 Test level	Compliance level	Electromagnetic Environment - guidance
Radiated RF EN 61000-4-3	3 V/m 80 MHz to 2.5 GHz	3 V/m	Portable and mobile RF communications equipment should be used no closer to any part of the <b>Equipment</b> , including cables, than the recommended separation distance calculated from the equation applicable to the frequency of the transmitter  <b>Recommended separation distance</b>  $d = 1.2 \times \sqrt{P}$ 80 MHz to 800MHz

			$d = 2.3 \times \sqrt{P}$ 800 MHz to 2.5GHz $d = 1.2 \times \sqrt{P}$ <p>Where <math>P</math> is the maximum output rating of the transmitter in watts (W) according to the transmitter manufacturer and <math>d</math> is the recommended separation distance in meters (m).</p> <p>Field strengths for fixed RF transmitter, as determined by an electromagnetic site survey, should be less than the compliance level in each frequency range</p> <p>Interference may occur in the vicinity of equipment marked with the following symbol:</p> 
--	--	--	---

NOTE 1 At 80 MHz and 800 MHz, the higher frequency range applies.

NOTE 2 These guidelines may not apply in all situations. Electromagnetic propagation is affected by absorption and reflection from structure, objects and people.

<sup>a</sup> Fields strengths from fixed transmitters, such as base stations for radio telephones and land mobile radios, amateur radio, AM and FM radio broadcast and TV broadcast cannot be predicted theoretically with accuracy. To assess the electromagnetic environment due to fixed RF transmitters, an electromagnetic site survey should be considered. If the measured field strength outside the shielded location in which the radiographic system is used exceeds [field strength] V/m, observe the radiographic system to verify normal operation. If abnormal performance is observed, additional measures may be necessary, such as relocating the radiographic system or using a shielded location with a higher RF shielding effectiveness and filter attenuation

<sup>b</sup> Over the frequency range 150 kHz to 80 MHz, field strengths should be less than 3 V/m.

The radiographic system PRS 500 B is intended for use in an electromagnetic environment in which radiated RF disturbances are controlled. The customer or the user of the radiographic system can help prevent electromagnetic interference by maintaining a minimum distance between portable and mobile RF communications equipment (transmitter) and the radiographic system as recommended below, according to the maximum output power of the communications equipment.

Rated maximum output power of the transmitter (W)	Separation distance according to frequency of transmitter (m)		
	150kHz to 80MHz $d = 1.2 \times \sqrt{P}$	80MHz to 800MHz $d = 1.2 \times \sqrt{P}$	800MHz to 2.5GHz $d = 2.3 \times \sqrt{P}$
0.01	0.12	0.12	0.23
0.1	0.38	0.38	0.73
1	1.2	1.2	2.3
10	3.8	3.8	7.3
100	12	12	23

For transmitters rated at the maximum output power not listed above, the recommended separation distance  $d$  in meters (m) can be estimated the equation applicable to the frequency of the transmitter, where  $P$  is the maximum output power rating of the transmitter in watts (W) according to the transmitter manufacturer.

**Note:**

- (1) at 80MHz and 800MHz, the separation distance for the higher frequency range applies
- (2) These guidelines may not apply in all situations. Electromagnetic propagation is affected by absorption and reflection from structures, objects and people.

## 7 Technical Data

### 7.1 Dimensions

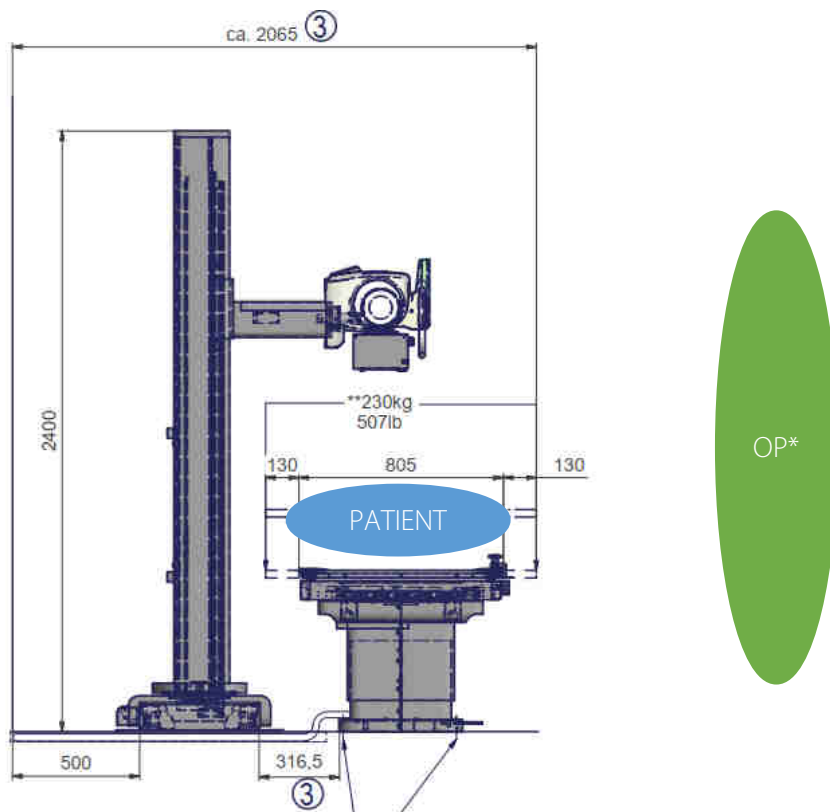
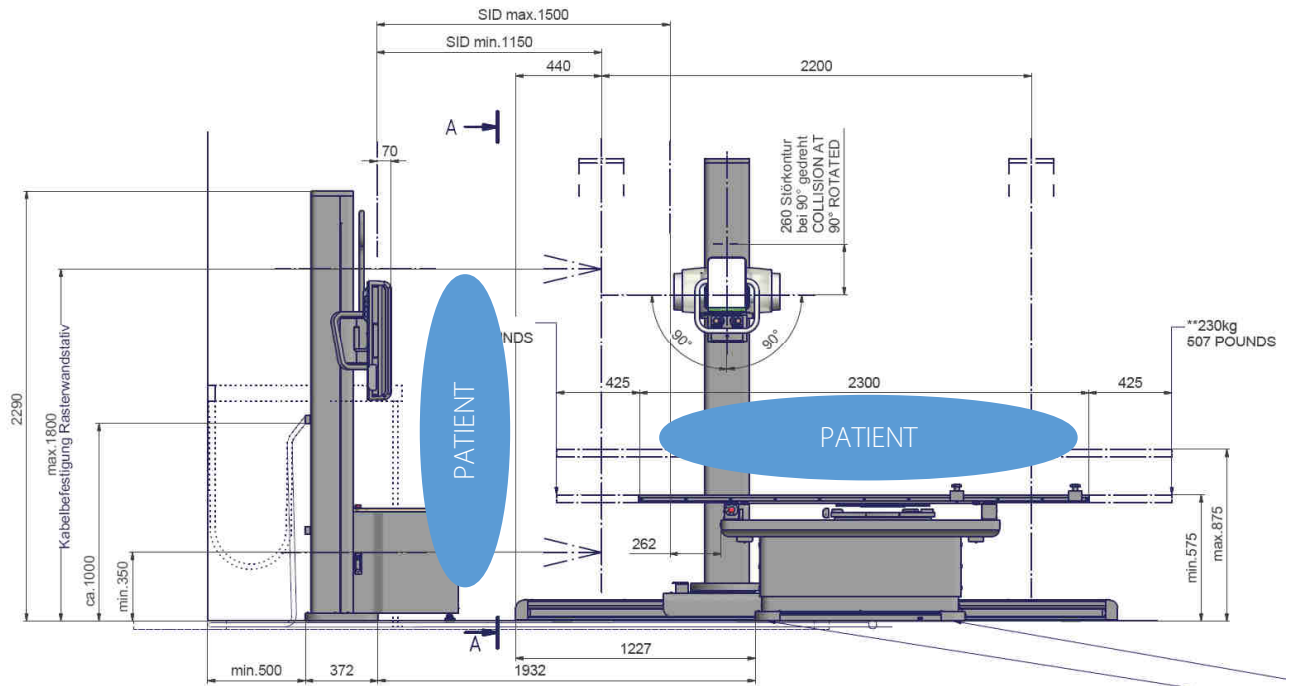

\*OP -Operator

## 7.2 X-ray table

Tabletop dimension (L x B):	2300mm x 805mm
Patient load, max	320kg
Tabletop height:	575 – 875 mm
Tabletop movement, transvers (from the mid-position):	± 130 mm
Tabletop movement longitudinal (from the mid-position):	± 425 mm

The brakes of the tabletop are used electro-4-pedal foot switch.

Detailed information please find in the enclosed User Manual, Technical Description of the PROGNOST B.

## 7.3 Bucky, Grid entity

Longitudinal travel:	430 mm
Min. distance Bucky center to table head end:	400 mm
Min. distance Bucky center to table foot end:	380 mm
Tabletop - film-distance:	70 mm

The Bucky, Grid entity and the measure chambers are connected to the generator.

Detailed information please find in the enclosed User Manual, Technical Description of the Bucky, Grid entity.

## 7.4 X-ray column

Focal spot vertical travel - horizontal X-ray beam:	350 - 1800 mm
Focal spot vertical – film distance:	max. 1295 mm
Focal spot vertical – table top distance:	max. 1225 mm

Angulation X-ray tube assembly	
Around horizontal support arm:	± 180°
Around tube column:	± 180°
Detents at:	- 90°, 0°, + 90°

Vertical travel supporting arm:	1450 mm
Tube stand longitudinal travel:	2200 mm

Detailed information please find in the enclosed User Manual, Technical Description of the PROGNOST B.

## 7.5 Wall column stand

Thorax Bucky Vertical travel – range of travel:	350 – 1800 mm
Longitudinal focus – Tube distance (Standard):	min. 110 mm

Detailed information please find in the enclosed User Manual, Technical Description of the PROGNOST B.

## 7.6 Attenuation Equivalent



### WARNING!

The X-ray system PRS 500 B can be delivered with different options on the Grid Entity/Bucky.

The attenuation factor must be determined at the final inspection at the customer. The variables like X-ray tube, Collimator etc. have influence to the factor. The attenuation value of the components can be read out of the accompanying documents of the component. The attenuation value has to be determined at the technical specifications. If the limits can't be kept please inform PROTEC immediately. If additional accessories are use it has a negative influence to the quality of the X-ray image.

The table top is defined as application part.

The aluminium attenuation equivalent of the tabletop is typically  $1,25 < 1,3$  Al mm for composite fibre, according to EN 60601-1-3. Tested at 100 kV with a first half-value layer thickness (HVL) of 3,7 mm Al and typically 0,6 mm Al und  $< 0,8$ mm Al according 21CFR § 1020-30 (n) with 100 kV and a first half-value layer thickness (HVL) of 2,7mm Al.

The cover vertical wall stand is defined as application part.

The aluminium attenuation equivalent of the cover vertical wall stand is typically 0,95 and  $< 1$  Al mm according to EN 60601-1-3. Tested at 100 kV with a first half-value layer thickness (HVL) of 3,7 mm Al.

### 7.6.1 Protection Art and Protection Class

The PRS 500 B is consistent with a protection class 1 device and contains applicable parts Type B (according to EN 60601-1).

## 7.7 Automatic cutoff dose

### 7.7.1 Analogue System

The automatic cutoff dose is 2,5 $\mu$ Gy.

### 7.7.2 Digital System

The automatic cutoff dose depends on the detector.

For RAPIXX systems, see Installation- & User manual of the corresponding RAPIXX system (Chapter 3.2; 3.3)

## 7.8 Environmental

### 7.8.1 Environmental conditions during operation

















Ambient Temperature	+ 10°C to + 40°C
Relative humidity	30% to 75% (non-condensing)
Atmospheric pressure	700 hPa to 1060hPa















### 7.8.2 Environmental Conditions for Shipping and Storage

Ambient Temperature	- 10°C to + 70°C
Relative humidity	10% to 95% (non-condensing)
Atmospheric pressure	500 hPa to 1060hPa

## 8 Description of symbols, labels and abbreviations

### 8.1 Symbols

	Limitation atmospheric pressure
	Limitation temperature
	Limitation humidity
	Keep dry
	Fragile, Handle with care
	Do not stack
	Do not tilt
	This way up
	Caution, note warning notice and safety instructions
	Refer to user manual
<b>CE 0297</b>	CE-Mark
	Classification according to EN 60601-1 (Type B)
	Caution: Collision hazard for head (standing people prohibited)
	Caution: pinch-/crushing hazard for hands and fingers
	Caution
	Warning high voltage
	Warning X-rays
	Do not exceed the maximum indicated weight

	Do not walk
	Do not stand on it
	Emergency OFF Switch label
	Table height adjustment – table up
	Table height adjustment – table down
	Release tabletop brakes
	Manufacturer
	Date of manufacture
	Serial number
	Order number
	Disposal Instructions; WEEE, Waste of Electrical and Electronic Equipment
 <a href="http://www.protoc-med.com/download">www.protoc-med.com/download</a>	This symbol indicates the need to consult the operating instructions. This is provided in an electronic format (eIFU) on our website.
	Error symbol, display on the touchscreen in CONAXX 2
	Warning symbol, display on the touchscreen in CONAXX 2
	Information symbol, display on the touchscreen in CONAXX 2

### 8.2 Type label

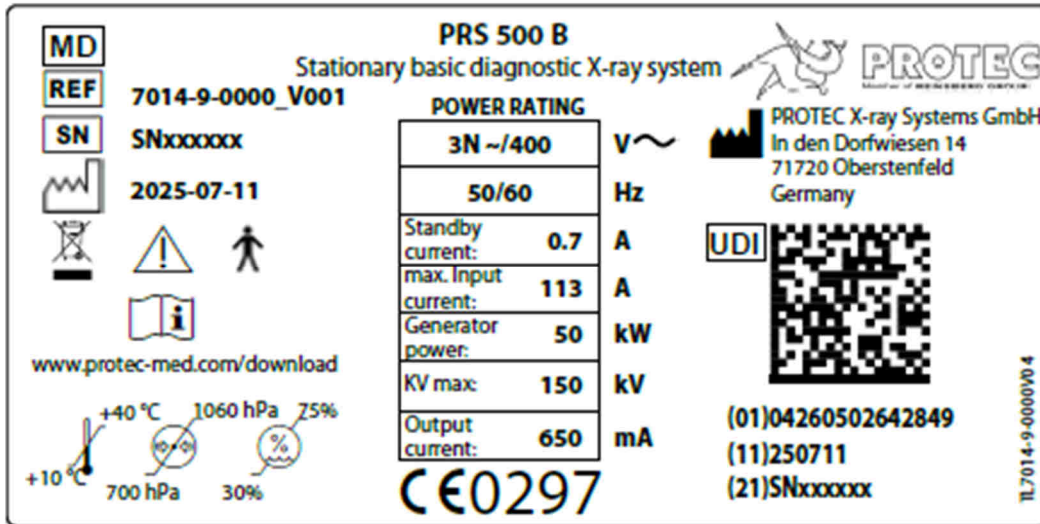

### 8.3 Labels

Labels on the side of the tabletop Labels on sides of the Tube column stand and Wall column stand



Caution: Possible pinch-/crushing hazard for the hands and fingers while moving the tabletop, table and or X-Ray tube assembly unit.

Label on the X-ray tube cover, left and right side



Caution: Possible collision hazard for head and other body part while moving the Tube assembly or tube column stand.

Labels on the front of Thorax Bucky housing



Maximum allowable weight

Labels on the table top



Maximum allowable patient weight on the table top

Labels on the floor rails



Don't step over the floor rails

Labels on the floor rails



Don't step on the floor rails

Labels on the tabletop



No putting your hand or fingers under the tabletop as the tabletop is moving

Label on the EC-Box



High voltage to be opened by authorized personnel only.

Label on the EC-Box and the cover X-ray column/floor rails

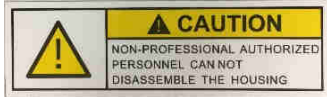

Non-professional authorized personnel can not disassemble the housing

Label on the X-ray tube cover



Warning X-rays

Label on the front plate x-ray system table



Manufacturer label

Labels on the X-ray column, column wall stand and EC-Box



Product label

### 8.4 Position symbols and labels

The identification label can be found on the side of the table near the bottom rear. Abbreviations

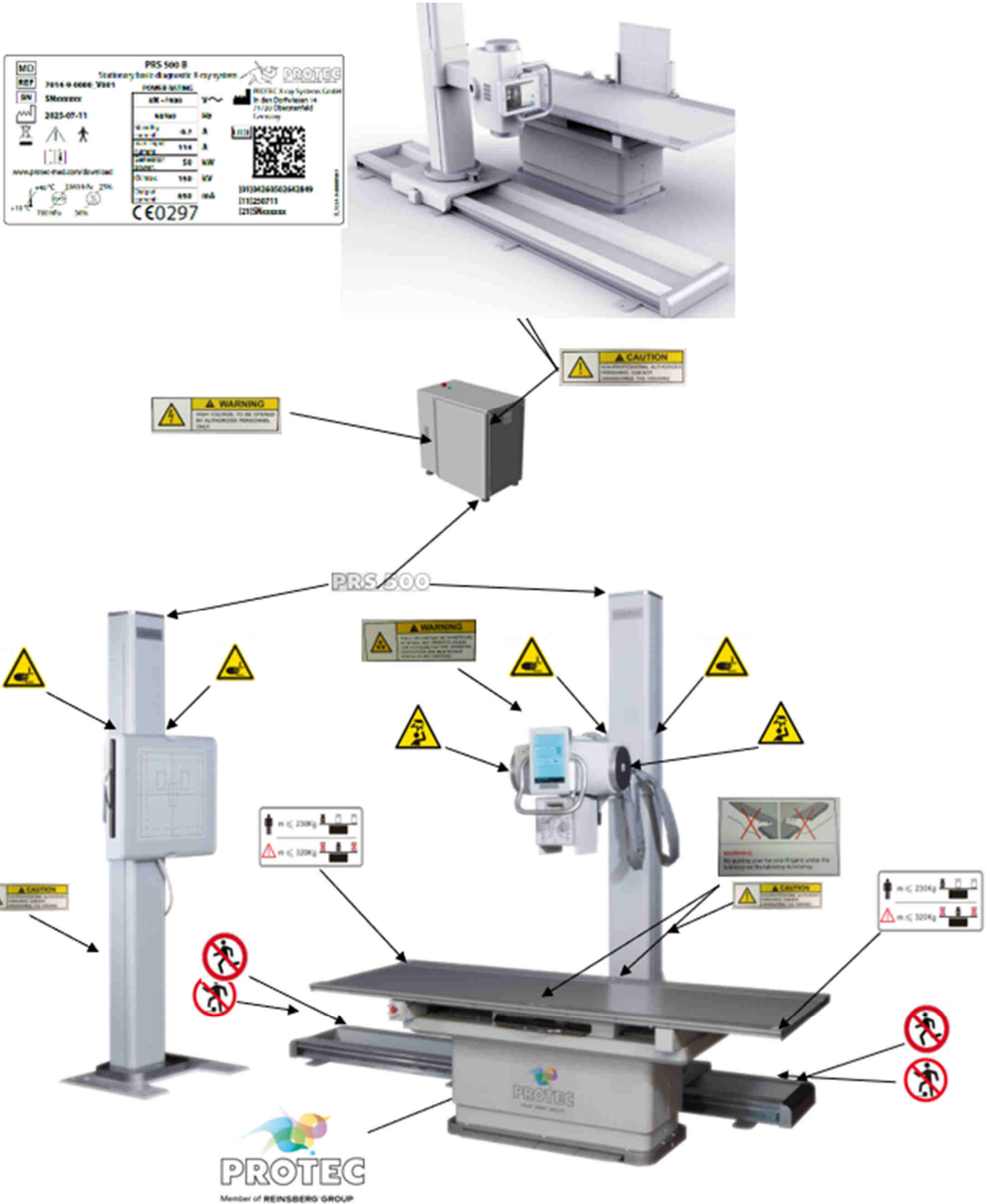

---

mm	Millimeter
cm	Centimeter
lb.	Pound
kg	Kilogram
°C	Degree -Celsius
hPa	Hectopascal
DIN	German Industry Standard
EN	European Standard
CE	CE-Mark
Hz	Hertz
ED	Duty cycle
A	Ampere
SN	Serial number