

PROSLIDE 32 B System

Mobile radiographic unit with DR-System

Model/ID: 7017-9-0000
Basis UDI-DI: 426050264X020ZF

System instructions for use shortform

Ident. Nr. 5017-0-0002



(Example configuration without RAPIXX-DR System)

Responsible for putting devices together
to this system acc. to Article 22 of
Regulation (EU) 2017/745:

PROTEC X-ray Systems GmbH
In den Dorfwiesen 14, 71720 Oberstenfeld, Germany
Telefon: +49 (0) 7062/92 55-0 E-Mail: protec@protec-med.com

Version: 6.0
Issue: 2025-07-01
Subject to change

**NOTE**

This document contains proprietary and confidential information of PROTEC X-ray Systems GmbH and is intended for exclusive use by current PROTEC X-ray Systems GmbH customers. Copying, disclosure to others or other use is prohibited without the express written authorization of PROTEC X-ray Systems GmbH's law department. Report any violations of this to PROTEC X-ray Systems GmbH.

© 2025 PROTEC X-ray Systems GmbH, Oberstenfeld

Send inquiries regarding this document to the following address:

PROTEC X-ray Systems GmbH

In den Dorfwiesen 14 | 71720 Oberstenfeld
Germany

Tel: (+ 49) 7062 – 92 55 0

Fax: (+ 49) 7062 – 92 55 60

E-Mail: protec@protec-med.com

Internet: www.protec-med.com

Table of content

	Page
Table of content	3
Revision Status	4
Radiation warning.....	5
1 Product description	6
1.1 Introduction	6
1.2 Intended use.....	6
1.3 Clinical Benefit	6
1.4 Patient target group	6
1.5 Medical conditions to be diagnosed.....	6
1.6 Indications and Contra Indications.....	6
1.6.1 Indications	6
1.6.2 Contra Indications.....	7
1.7 Intended user group.....	7
1.8 Declaration according to Article 22.....	7
2 Operating Elements and Displays	8
2.1 Overview of the components.....	8
2.1.1 Operating Elements and Displays PROSLIDE 32 B.....	8
2.1.2 Operating Elements and Displays of the CONAXX 2 Software.....	8
2.1.3 Operating Elements and Displays of the RAPIXX System	8
2.1.4 Operating Elements and Displays of the Panel-PC*	8
3 Handling	9
3.1 X-ray tube warm-up before start of operation	9
3.2 Operation.....	9
3.2.1 Operation of PROSLIDE 32 B.....	12
3.2.2 Operation of CONAXX 2.....	12
3.2.3 Operation of the RAPIXX-DR System.....	12
3.2.4 Operation of Panel-PC*	12
3.3 Functions of the PROSLIDE 32 B SYSTEM.....	12
3.3.1 Switching the PROSLIDE 32 B system OFF and ON.....	12

**NOTE**

The information contained in this short system instructions for use to the system configuration as of the date of delivery. Changes made after delivery will be incorporated into a new version of this document.

Current versions of this document can be accessed at any time via the PROTEC website.

Revision Status

Revision	Date	List of updated pages	Comment	Author
1.0	2017-03-13	all	Original issue	ML
2.0	2019-11-29	3, 4, 8	NOTE changed; Cap. 1 new; Cap. 3.1 WARNING new	ML
3.0	2020-11-03	Title page, 5	Model/ID, Intended use	ML
4.0	2021-07-20	Title page, 5, 6	change to article 22	ML
5.0	2022-03-11	9	X-ray tube warm-up new	MB
6.0	2025-07-01	all	First edition "PROTEC X-ray Systems GmbH"	DP

Radiation warning



WARNING!

The system described in this document is intended for the generation of X-rays in medical diagnostics.

X-rays generate a potential risk for both patients and operators.

For this reason the application of X-rays for a given medical purpose must aim at the minimization of radiation exposition to any person.

Those persons responsible for the application must have the specific knowledge according to legal requirements and regulations and must establish safe exposure procedure for these kind of systems. The responsible persons for planning and installation of this equipment must observe the national regulations.

1 Product description

1.1 Introduction

This System Quick Guide summarizes the most important information for efficient and effective operation of the PROSLIDE 32 B system.



NOTE

Before you work with the PROSLIDE 32 B System, it is imperative that you read the applicable instructions for the two system components PROSLIDE 32 B and RAPIXX DR System with detailed safety and handling instructions. These documents are in charge and valid in their current version.

1.2 Intended use

The PROSLIDE 32 B Systems as mobile general-purpose diagnostic X-ray systems with DR-System are intended in a variety of routine planar x-ray imaging applications in human medicine. They are used in hospitals and enable the acquisition, image processing and transmission of digital, conventional X-ray images at various locations within the hospital.

1.3 Clinical Benefit

The clinical benefit of using diagnostic X-ray systems in human medicine is the generation of conventional two-dimensional X-ray images for creation or specification of findings as a basis for treatment decisions.

1.4 Patient target group

The intended patient group includes all people for whom a justifying indication for a medical X-ray has been given by a physician with the necessary expertise in radiation protection.

There are no general or fundamental restrictions on the patient group regarding age, gender, origin and patient condition.

1.5 Medical conditions to be diagnosed

A complete list of indications is unrealisable for conventional radiography, because the spectrum of conventional X-rays is very diverse and can vary in the course of medical-technical progress.

Some examples of indications for an X-ray examination may be:

Some examples of indications for an X-ray examination may be:

- For the diagnosis of a bone fracture or bony injuries of the skeletal system or pathological changes of hard tissues.
- To control the bone setting.
- For the diagnosis of luxations and ligament ruptures of the locomotor system.
- For the diagnosis of degenerative, inflammatory, traumatic and tumorous diseases and changes of the locomotor system.
- For diagnostic of malformations and malalignments of the skeletal system.
- For the diagnosis of thoracic and pulmonary symptoms (thorax exposures)
- For the diagnosis of sclerotherapy.
- For the diagnosis of inflammatory and expansive processes of the mucosa, cranial bones and paranasal extension.
- For the diagnosis of the abdomen (e.g. acute abdomen, plain abdominal radiography, urethrogram, cystogram).

1.6 Indications and Contra Indications

1.6.1 Indications

According to §83 of the German radiation protection law (StrlSchG), an X-ray examination is only justified if the patients benefit from x-ray diagnostics outweighs the radiation risk. The examination method, means the conventional X-ray with the PROSLIDE 32 B System, must be suitable to answer the diagnostic question and no other more suitable alternative method is available.

Accordingly, it is also described by the International Atomic Energy Agency (IAEA) in the document Radiation Protection and Safety of Radiation Sources: International Basic Safety Standards (Requirement 37: Justification of medical exposures). It also refers to the need to consider national or international guidelines for the justification of a medical exposure.

**NOTE**

Even if, according to the justifying indication, the benefit predominates the radiation risk, it must not be disregarded that there are residual risks due to ionising radiation and that undesirable side effects may occur. Ionising radiation (X-radiation) can damage the genome and, in the long term, lead to cancer and mutations and thus damage the human body.

1.6.2 Contra Indications

There are no absolute contraindications for conventional X-rays. But it is not allowed to make any exposures on humans when they are not medically indicated (see Justification of medical exposures,). For pregnant women and children it is important to consider if the exposure is really necessary. It should be avoided if possible.

1.7 Intended user group

The mobile radiographic system PROSLIDE 32 B is exclusively designated for use by professional who are trained, in accordance with the corresponding national regulations, in the use of diagnostic X-Ray equipment and its proper intended use in connection with other medical devices, objects and accessories.

Suitable users could include the following: Radiologist, radiology assistants, radiology technicians, doctors and other medically trained personnel.

1.8 Declaration according to Article 22

The Declaration according to Article 22 of Regulation (EU) 2017/745 is available on request from PROTEC:

PROTEC X-ray Systems GmbH
In den Dorfwiesen 14 | 71720 Oberstenfeld
Phone: +49 (0) 7062 – 92 55 0
Fax: +49 (0) 7062 – 92 55 60
E-mail: protec@protec-med.com
Internet: www.protec-med.com

2 Operating Elements and Displays

2.1 Overview of the components

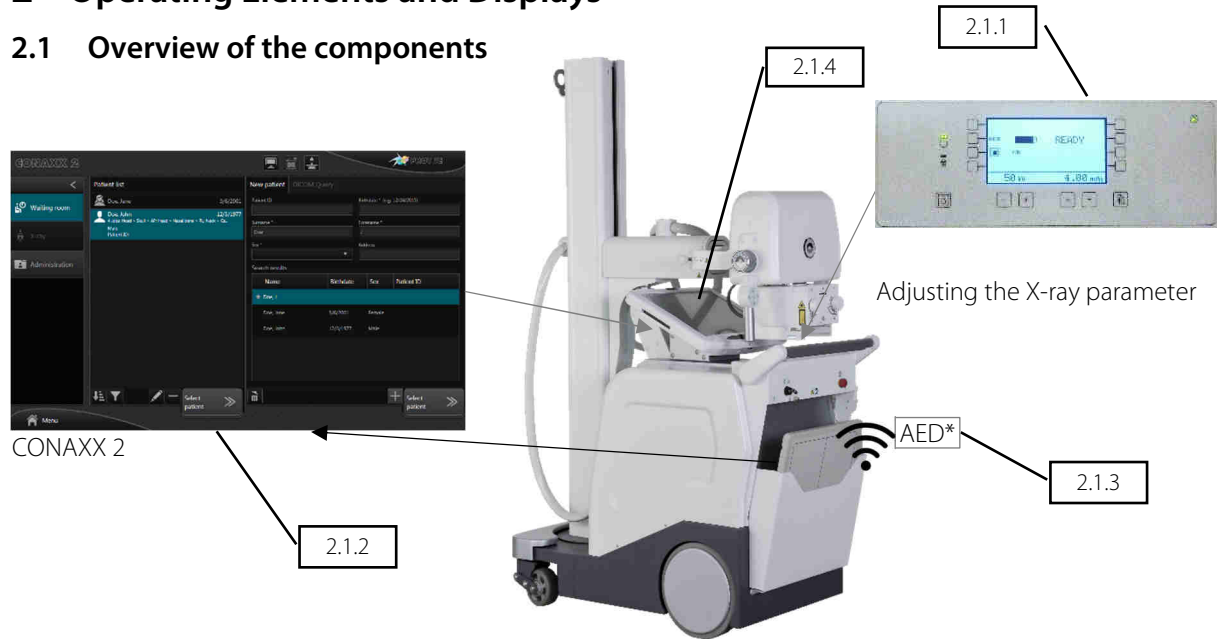

* AED – Automatic Exposure Detection

2.1.1 Operating Elements and Displays PROSLIDE 32 B

You can find further information of the mobile X-ray unit in the user manual for this component.

2.1.2 Operating Elements and Displays of the CONAXX 2 Software

You can find further information of the CONAXX 2 in the user manual for this component.

2.1.3 Operating Elements and Displays of the RAPIXX System

You can find further information of the RAPIXX-systems in the user manual for this component.

2.1.4 Operating Elements and Displays of the Panel-PC*

You can find further information of the Panel-PC in the user manual for this component.

* Not included in delivery. Please order separately.

3 Handling

3.1 X-ray tube warm-up before start of operation



NOTE

With a warm-up process of the X-ray tube early defects of the X-ray tube unit and the generator are minimized and thus the service life of the components is increased.



CAUTION!

The X-ray tube warm-up process is performed without the detector. The detector must not be irradiated during these exposures.

1. Close the collimator shutters.
2. The CONAXX 2 software is not required. The required parameters are set via the keyboard and the display of the PROSLIDE.
3. Select the large focus first.
4. Perform the exposures using the following table.
5. The break between the exposures must be at least 10 seconds.

Large focus	60 kV	5 mAs
Large focus	70 kV	5 mAs
Large focus	80 kV	5 mAs
Large focus	90 kV	5 mAs
Large focus	100 kV	5 mAs
Small focus	60 kV	5 mAs
Small focus	70 kV	5 mAs
Small focus	80 kV	5 mAs
Small focus	90 kV	5 mAs
Small focus	100 kV	5 mAs

3.2 Operation

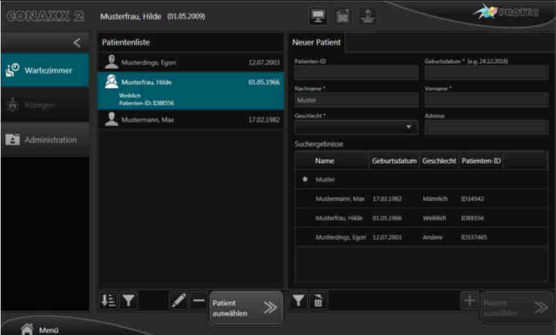
Description	Picture
Switch on the PROSLIDE 32 system	Switch-on sequence: <ul style="list-style-type: none"> - Generator - RAPIXX DR-System - Panel-PC*
Start CONAXX 2 Chose patient and region of interest in CONAXX 2 Prepare exposure in CONAXX 2	 <p>The screenshot shows the CONAXX 2 software interface. On the left, there is a 'Patientenliste' (Patient List) with columns for name, date of birth, and patient ID. Three patients are listed: 'Mutterfrau, Egon' (12.07.2003), 'Mutterfrau, Hilde' (01.05.1966), and 'Muttermann, Max' (17.02.1962). The 'Mutterfrau, Hilde' entry is selected. On the right, there is a 'Neuer Patient' (New Patient) form with fields for name, date of birth, gender, and address. Below the form is a search results table with columns for Name, Geburtdatum, Geschlecht, and Patienten ID. The search results table contains three entries: 'Muttermann, Max' (17.02.1962, Männlich, E01542), 'Mutterfrau, Hilde' (01.05.1966, Weiblich, E08938), and 'Mutterfrau, Egon' (12.07.2003, Anders, E017465).</p>

Set up generator values

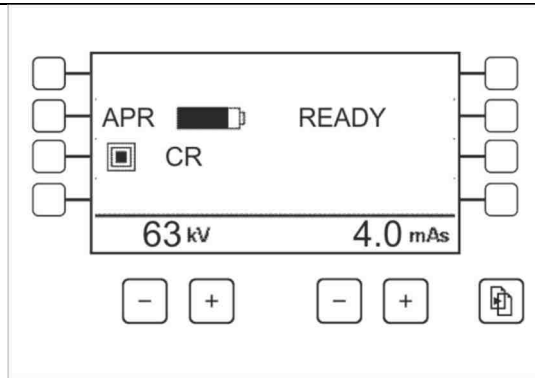

Position detector, x-ray tube and patient

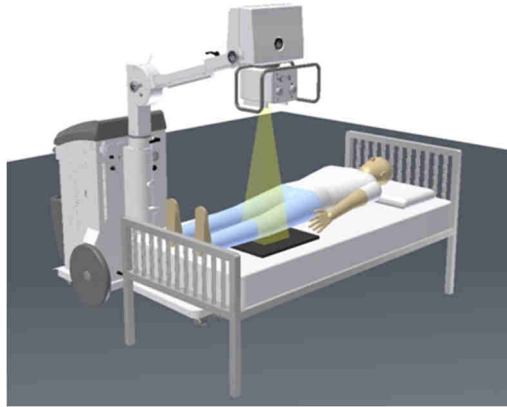
**WARNING!**

The central beam and the detector surface (or CR or film) should always be positioned orthogonally to each other and centrally in the beam field for optimum imaging. The active surface of the detector (or CR or film) must always point towards the radiation field.

Prepare CONAXX for exposure

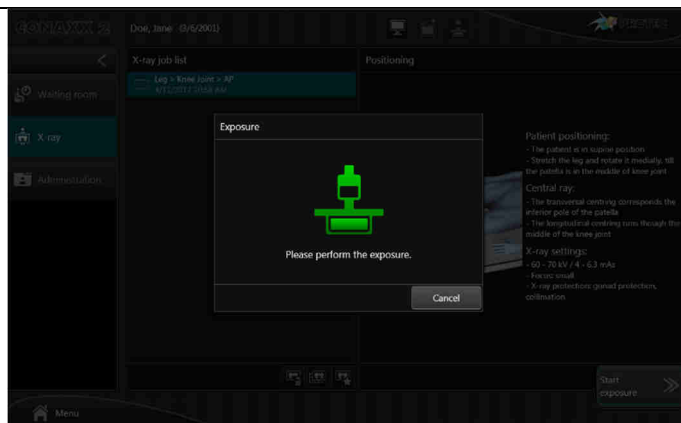

Make the exposure

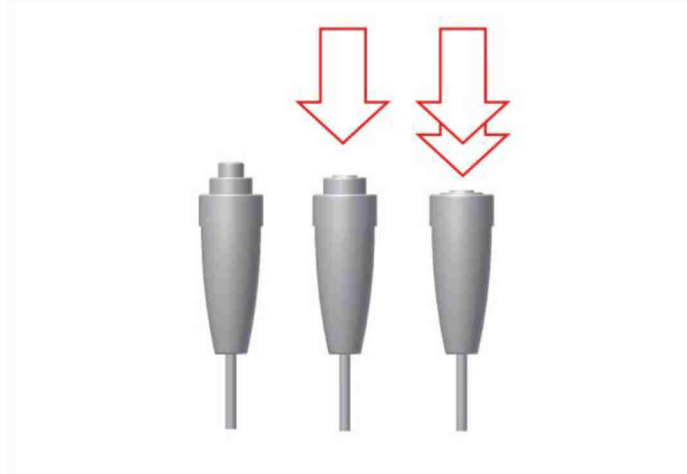

View the image



Prepare X-ray tube and detector for next exposure or bring them into transport position

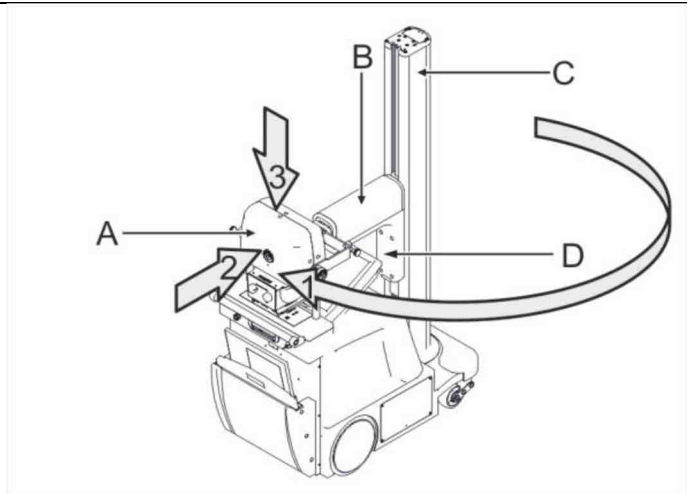

Copy exposures to the clinical system

Detailed information of using the components can be found in the respective user manual.

3.2.1 Operation of PROSLIDE 32 B

Detailed information of using the PROSLIDE 32 B can be found in the user manual.

3.2.2 Operation of CONAXX 2

Detailed information of using the CONAXX 2 can be found in the user manual.

3.2.3 Operation of the RAPIXX-DR System

Detailed information of using the RAPIXX-DR system can be found in the user manual.

3.2.4 Operation of Panel-PC*

Detailed information of using the PANELPC can be found in the user manual.

3.3 Functions of the PROSLIDE 32 B SYSTEM**3.3.1 Switching the PROSLIDE 32 B system OFF and ON**

To switch on the complete PROSLIDE 32 B system it has to be switched on 3 components. We recommend the following sequence of switching on:

1. Generator (PROSLIDE 32 B)
2. RAPIXX DR-System
3. Panel-PC*

Detailed information about switching on the component can be found in the respective user manual.

* Not included in delivery. Please order separately.