

RAPIXX DR-System

4336M1F ES CC Set

4336M2F ES CC Set

4343M1F ES CC Set

4343M2F ES CC Set

Digital X-ray detector system

Model/ID: 4999-9-0000_Vxxx
Basic UDI-DI: 426050264D001UX

Instructions for use & Installation Manual

ID no. 5507-0-9004

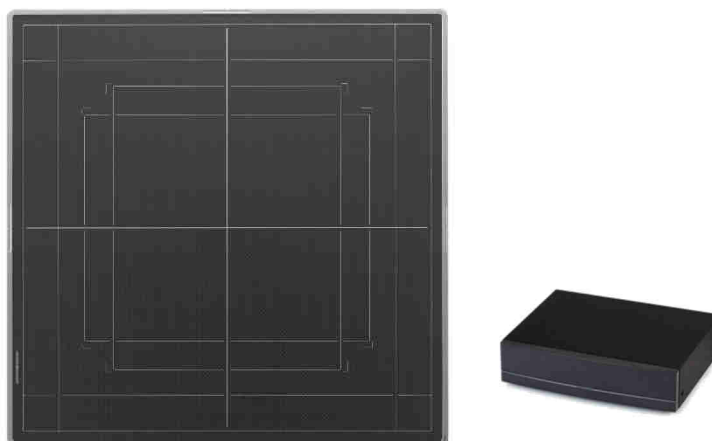

Figure RAPIXX 4343M1F/M2F

Responsible for assembling
of products to this system
according to Article 22 of Regulation (EU) 2017/745:

PROTEC X-ray Systems GmbH
In den Dorfwiesen 14, 71720 Oberstenfeld, Germany
Telephone: +49 (0) 7062/92 55-0 E-Mail: protec@protec-med.com

Version: 3.0
Issued: 2025-07-18
Subject to alterations



NOTE

All sheets of this document contain proprietary and confidential information of PROTEC X-ray Systems GmbH and is intended for exclusive use by current PROTEC X-ray Systems GmbH customers. Copying, disclosure to others or other use is prohibited without the express written consent of PROTEC's law department. Knowledge of violations of these regulations must be reported immediately to PROTEC X-ray Systems GmbH.

© 2025 PROTEC X-ray Systems GmbH, Oberstenfeld

Comments and questions about the documentation, please contact:

PROTEC X-ray Systems GmbH

In den Dorfwiesen 14 | 71720 Oberstenfeld
Germany

Phone: (+ 49) 7062 – 92 55 0

Fax: (+ 49) 7062 – 92 55 60

E-Mail: protec@protec-med.com

Internet: www.protec-med.com

Table of contents

	Page
Table of contents	3
Revision Status	5
Radiation Warning	6
To the User	6
1 Device Description	7
1.1 Introduction	7
1.2 Description.....	7
1.2.1 System Components	7
1.2.2 Hardware and Network System Requirements	8
1.3 Performance Characteristics	8
1.4 Intended Use	8
1.5 Clinical Benefit	8
1.6 Patient Target Group(s).....	8
1.7 Medical Conditions to be diagnosed.....	8
1.8 Indications and Contraindications	8
1.9 Intended User Group.....	9
1.10 Declaration according to Article 22.....	9
2 Safety Instructions	10
2.1 General Safety Instructions	10
2.1.1 Device Operation	10
2.1.1.1 Operating Type	10
2.1.2 Operating Personnel	10
2.1.3 Explosion Protection	11
2.1.4 Interaction with Other Devices.....	11
2.1.5 Electromagnetic Environment and Influencing of Devices	11
3 Installation	12
3.1 Checklist	13
3.2 Connection of the components.....	13
3.3 Connection of the anti-scatter grid detection.....	13
3.4 Installation of the supplied network card.....	14
3.5 Installation of CONAXX 2	14
3.6 Set-up the network.....	14
3.7 Change Windows Settings.....	15
3.7.1 User Account Control Deactivation	15
3.7.2 Activate Windows features.....	16
3.7.3 Windows Firewall Customization.....	16
3.8 Installation of the Detector DVD	16
3.9 User Group Customization	17
3.10 Configuration of the detector.....	17
3.10.1 Synchronization	18
3.10.2 Hardware	18
3.10.3 Wifi.....	18
3.10.4 Register the Detector.....	18
3.11 First start of CONAXX 2.....	18
3.11.1 Necessary settings in CONAXX 2	18
3.11.2 Licensing of CONAXX 2	18
3.11.3 Activation of CONAXX 2 Modules.....	20
3.12 Dose indicator settings for detector	20
4 Calibration of the DR-System	21
5 Control Elements and Displays	23
5.1 Control Elements and Displays of the Detector	23
5.2 Control Elements and Displays of the CONAXX 2 Acquisition Software.....	23

6	Handling	24
6.1	Requirements before and during Operation.....	24
6.2	Operation.....	24
6.2.1	Start-up order for daily use.....	24
6.2.2	Operation of the CONAXX 2 acquisition software.....	24
6.2.3	Operation of the detector with accessories	24
6.3	Function of the digital X-ray detector system	25
6.3.1	Switching the RAPIXX DR-System on	25
6.3.2	Switching the RAPIXX DR-System off	25
6.3.3	X-ray generator errors during operation	25
6.3.4	Modality errors during operation.....	25
7	Safety and Maintenance.....	26
7.1	Introduction	26
7.2	Reusability	26
7.3	Cleaning and Disinfection	26
7.3.1	Cleaning.....	26
7.3.2	Disinfection.....	27
7.4	Inspection and Maintenance.....	27
7.4.1	Daily Monitoring before and during the Examination Operation.....	27
7.4.2	Regular Monitoring.....	27
7.4.3	Maintenance	27
7.4.4	Warranty.....	28
7.4.5	Product Service Life	28
7.4.6	Further Information	28
7.4.7	Applied Parts and Parts Considered as Applied Parts.....	28
7.4.8	Disposal Notes	28
8	Power Supply	29
8.1	Electromagnetic Compatibility (EMC) according to EN 60601-1-2	29
9	Technical Data.....	30
9.1	Dimensions Detector	30
9.2	Technical Data Detector.....	30
9.3	Protection Type and Protection Class.....	30
9.4	Automatic Cut-off dose	30
9.5	Environmental Conditions	31
9.5.1	Environmental Conditions during Operation.....	31
9.5.2	Environmental Conditions for Shipping and Storage	31
10	Description of Symbols, Labels and Abbreviations.....	32
10.1	Symbols	32
10.2	Type Label	34
10.2.1	RAPIXX DR-System.....	34
10.2.2	Detector.....	34
10.2.3	Power Box of the Detector.....	34
10.2.4	INTERFACE BOX	34
10.2.5	CONAXX 2.....	35
10.3	Positions of the Signs and Labels.....	35
10.3.1	Detector.....	35
10.3.2	INTERFACE BOX	35
10.4	Abbreviations.....	36

**NOTE**

The information contained in these instructions for use conforms to the configuration of the system equipment as of the date of manufacture. Revisions made after the delivery are incorporated in a new version of this document. Current versions of the document can be accessed at any time via the PROTEC website.

Revision Status

Revision	Date	Updated pages	Comments	Author
1.0	2022-01-31	all	Original issue Article 22 system	MB
2.0	2023-05-08	17, 18	Hint and screenshot for configuration added	FR
3.0	2025-07-18	All	First edition PROTEC X-ray Systems GmbH	ML

Radiation Warning



WARNING!

In these accompanying documents, a system or a component for such a system is documented, which is used for the intended generation of X-rays in medical diagnostics.

X-rays are ionizing radiation which can cause damage to living organisms (e.g., cancer or mutations).

X-rays pose a potential risk to patients and employees.

Therefore, the aim of any radiation application and given medical issue is to minimize the radiation exposure for both groups of persons.

The persons responsible for the application must have the necessary expertise in accordance with the regulations and guidelines and apply the procedures for the safe operation of such systems.

National regulations must also be observed during planning and installation.

X-rays are generated in the X-ray tube by strong deceleration of previously accelerated electrons, which emits energy in the form of electromagnetic waves. The intensity depends on the set parameters of voltage (kV), current (mA) and time (s) at the X-ray generator. The X-rays are emitted only at a beam exit window of the tube and are limited by the collimator placed directly below it.

To the User



NOTE

The user of these accompanying documents is required to carefully read through and carefully consider the instructions, warnings and cautions contained therein before starting operation.

Even if you have already operated similar systems, changes in the design, production and functional routine of the system described here may have been made, which have a significant influence on the operation.

Even if the product was the subject of a hazard analysis and the design corresponds to the current state of the art, residual risks remain during clinical use. These are represented in the following instructions for use by limits of use, contraindications, warnings and precautions.

Assembly and service works on the system described here must be carried out by authorised and qualified personnel from PROTEC X-ray Systems GmbH. Assembly personnel and other persons who are not employees of the technical service department of PROTEC X-ray Systems GmbH are requested to contact the local branch of PROTEC X-ray Systems GmbH before assembly or service work is started. For assembly and service works, it is necessary to use the "Technical Description" of the product and to observe the points it contains.

1 Device Description

1.1 Introduction

The instructions for use summarize the most important information for efficient and effective operation of the RAPIXX DR-system.



NOTE

Before working with the RAPIXX DR-system, it is mandatory to read the applicable original manuals for the system components with detailed safety and handling instructions. These documents are leading and valid in their current version.

1.2 Description

The digital X-ray detector systems of the RAPIXX-series are intended for conventional radiography. The detectors of the RAPIXX-set serve as an image receiver that displays X-ray images in digital form on a monitor or display. The CONAXX 2 acquisition software included in the set is responsible for image reception, image processing and image subsequent processing.

The digital X-ray detector systems of the RAPIXX-series are assembled from individual components that are stand-alone medical devices, but which must be interconnected to fulfil their intended purpose.

1.2.1 System Components

The RAPIXX DR-system consists of the following system components:

- Detector, e.g., RAPIXX 4336M1F ES CC
 - Detector cable
 - Power box incl. power cable
 - Detector DVD
- CONAXX 2 acquisition system software (on data carrier)
- Network cable 15m
- Network card
- Documentation RAPIXX DR-system (on data carrier)

Optional system components

- INTERFACE BOX (for anti-scatter grid detection)
- CONAXX 2 Module
 - CONAXX 2 X-Ray Journal
 - CONAXX 2 Gridline Suppression
 - CONAXX 2 DICOM Print
 - CONAXX 2 Generator Connection
 - CONAXX 2 Patient CD
 - CONAXX 2 Stitching
 - CONAXX 2 DICOM Query
 - CONAXX 2 DICOM Worklist
 - CONAXX 2 Diagnostic Viewer
 - CONAXX 2 Dual Panel

Optional accessories

- Detector protective housing
- PC or Notebook

Accessories that can influence the EMC conditions

- Network cable (take note of the max. cable length in the component documents)
- RAPIXX data connection cable (take note of the max. cable length in the component documents)

1.2.2 Hardware and Network System Requirements

When using the digital X-ray detector system, it should be ensured that the country-specific requirements for data protection and IT security are met.

The system requirements for the optional system components (RAPIXX-series) can be found in the current document supplied, "EN_5330-0-0026_CONAXX2_System_Requirements".

1.3 Performance Characteristics

See instructions for use of the individual components.

1.4 Intended Use

The RAPIXX-series of digital X-ray detector systems are intended as system components of diagnostic X-ray systems for the acquisition, image processing and data transmission of conventional X-ray images for various routine applications in planar X-ray imaging in human medicine.

RAPIXX DR-systems are not intended for mammography or dental applications.

1.5 Clinical Benefit

The clinical benefit of digital X-ray detector systems in human medicine, in combination with a diagnostic X-ray system, is the generation of conventional two-dimensional X-ray images for creation or specification of findings as a basis for treatment decisions.

In addition, compared to analogue X-ray technology, digital X-ray detector systems have a wider tolerance range of the X-ray dose required for a conventional X-ray image. This wider tolerance range reduces the dose exposure of patients, as equivalent X-ray images can be produced with lower doses and repeat exposures can be avoided.

1.6 Patient Target Group(s)

The intended patient group includes all people for whom a justifying indication for a medical X-ray has been given by a physician with the necessary expertise in radiation protection.

There are no general or fundamental restrictions on the patient group regarding age, gender, origin and patient condition.

1.7 Medical Conditions to be diagnosed

A complete list of medical conditions to be diagnosed is not feasible, as the range of conventional radiographs is very diverse and may also vary in the course of medical-technical progress.

Examples for medical conditions to be diagnosed are:

- Bone fracture or bony injuries of the skeletal system or pathological changes of the bony tissue.
- Control of the correct set-up of the fracture.
- Luxation and bony ligament tears of the musculoskeletal system.
- Degenerative, inflammatory, traumatic and tumorous diseases and changes of the musculoskeletal system.
- Deformities and defective positions of the skeletal system.
- Thoracic and pulmonary symptomatology (thorax exposures).
- Sclerosis.
- Inflammatory and expansive processes of the mucous membrane, craniofacial bones and the expansion of the paranasal sinuses.
- Disease of the abdominal cavity (e.g., acute abdomen, abdominal overview radiograph, urethrogram, cystogram).

1.8 Indications and Contraindications

As standalone products, X-ray detector systems have no intended main effect in or at the human body. Therefore, considered in isolation, no indications or contraindications can be shown for them.

1.9 Intended User Group

RAPIXX DR-systems are intended exclusively for use by professional users who are trained in the operation of diagnostic X-ray systems, in combination with a digital X-ray detector system, in accordance with the respective national regulations and who are familiar with the proper handling, use and operation and also have been instructed in the permitted conjunction with other medical products, objects and accessories.

Appropriate users can be, for example: X-ray technicians, X-ray assistants, medical technical X-ray assistants, surgeons, casualty surgeons, orthopedists and other trained medical personnel.

1.10 Declaration according to Article 22

The declaration according to article 22 of regulation (EU) 2017/745 is available upon request from:

PROTEC X-ray Systems GmbH

In den Dorfwiesen 14 | 71720 Oberstenfeld

Germany

Phone: (+ 49) 7062 – 92 55 0

Fax: (+ 49) 7062 – 92 55 60

E-Mail: protec@protec-med.com

Internet: www.protec-med.com

2 Safety Instructions



NOTE

Contains information that must be observed during operation.

xxx



CAUTION!

Contains information which, if not observed, can cause property damage.

xxx



WARNING!

Contains information which, if not followed, can cause personal injury.

xxx



WARNING!

Warning of radioactive substances or ionizing radiation. Contains information which, if not observed, can cause personal injury.

xxx

Settings and calibrations that are not described in these instructions for use must be carried out using the technical description of the individual components by PROTEC service department or a service company authorized by them.



NOTE

All supplied instructions must be observed and the safety instructions contained therein must be carefully read and adhered to.



CAUTION!

The instructions for use contain all the information relevant to safety in order to generally put the digital X-ray detector system into operation. The device may only be operated by appropriately trained and trained personnel. In this context, operation is ensured by clear symbols on the control elements. All further information and instructions can be found on the supplied data carrier (USB, CD or DVD). This information applies in its entirety as an appendix to these instructions for use and must be observed.

2.1 General Safety Instructions

2.1.1 Device Operation

In case of a malfunction, do not use the digital X-ray detector system anymore and notify PROTEC service department or a service company authorized by them.

2.1.1.1 Operating Type

The digital X-ray detector system is intended for continuous operation.

2.1.2 Operating Personnel



NOTE

Only trained and authorized personnel are allowed to work on the digital X-ray detector system.

**NOTE**

The operating personnel must be familiar with all warning signs attached to the digital X-ray detector system. They are used for your own safety and that of others and ensure proper operation.

2.1.3 Explosion Protection

The digital X-ray detector system is not designated for use within areas with explosive hazards.

2.1.4 Interaction with Other Devices

Interactions with other devices are not known.

2.1.5 Electromagnetic Environment and Influencing of Devices

**CAUTION!**

The use of other accessories, other converters and other cables than those specified by PROTEC or provided in the documentation of the component manufacturer can result in increased electromagnetic interference or reduced electromagnetic immunity of the device and lead to defective operation.

**CAUTION!**

The use of the digital X-ray detector system immediately next to other devices or with other devices in a stacked form should be avoided, as this could result in defective operation. If use in the manner described above is nevertheless necessary, the digital X-ray detector system and the other devices should be observed to ensure that they are working properly.

**NOTE**

The properties of this device, determined by emissions, allow its use in industrial areas and in hospitals (CISPR 11, class A). When used in residential areas (for which class B is usually required by CISPR 11), this device may not provide adequate protection for radio services. The user may need to take remedial measures such as relocating or realigning the device.

The digital X-ray detector system is intended for use in an environment in professional health care facilities (e.g., clinics, surgery centers, physiology practices ...).

3 Installation



NOTE

The installation of the digital X-ray detector system must be performed by PROTEC customer service or a service authorized by it.



CAUTION!

The digital X-ray detector system must not be installed in the following locations to avoid malfunction, damage, fire or injury:

- **Where there are large temperature fluctuations.**
 - **Near heat sources e.g., a heater.**
 - **In an environment containing salt or sulfur.**
 - **In the vicinity where water can escape.**
 - **Where corrosive gas may be generated.**
 - **In a dusty environment.**
 - **Where the device is exposed to frequent or excessive vibrations or shocks.**
 - **Where the device is exposed to direct sunlight.**
 - **Where the ambient conditions for temperature, humidity and air pressure cannot be maintained.**
-

For detailed information, please refer to the installation manuals of the individual components.



NOTE

Use only supplied network cables or well-shielded cables of category CAT6 or higher.



NOTE

The anti-scatter grid recommended for this type of detector depends on factors such as grid motorization. Therefore, the grid to be used should be coordinated with PROTEC X-ray Systems GmbH in advance.



WARNING!

PROTEC X-ray Systems GmbH assumes no liability for the selection of the anti-scatter grid.



WARNING!

If the detector of the RAPIXX DR-system is operated via data cable and with direct patient contact, it must be ensured that the data cable is equipped with a network isolator in accordance with EN 60601-1.

3.1 Checklist

If the installation has already been prepared by PROTEC, only the following subchapters of this chapter need to be observed:

- Fehler! Verweisquelle konnte nicht gefunden werden.2 Connection of the components
- 3.3 Connection of the anti-scatter grid detection

Afterwards continue with the chapter "4. Calibration of the DR-System".

3.2 Connection of the components

Connect the components as described in the following schematic diagram.

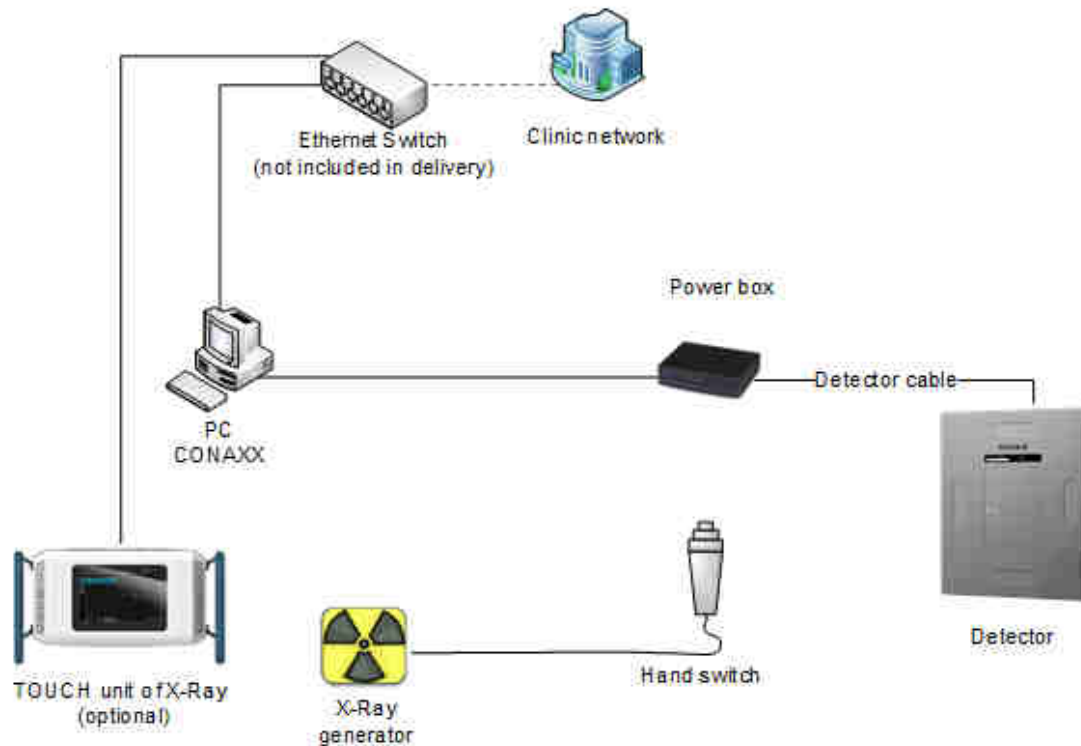

3.3 Connection of the anti-scatter grid detection

When using a PROTEC X-ray system (PRS 500 or PEDS 600) with built-in anti-scatter grid detection, this must be connected to the INTERFACE BOX.

The following connections are provided for anti-scatter grid detection of the Bucky or Grid Entity:

Connector	Cable color	Function
17	Yellow	Grid switch 2
16/18/20	White	COM
19	Green	Grid switch 1



NOTE

The connections in the table and on the wall stand are identical.

The following connections are available on the INTERFACE BOX side:

Connector	Cable color	Function
X7-1	Green	Wall grid switch 1
X7-2	Yellow	Wall grid switch 2
X7-6	White	Wall COM

X8-1	Green	Table grid switch 1
X8-2	Yellow	Table grid switch 2
X8-6	White	Table COM

3.4 Installation of the supplied network card

Switch off the PC and open the housing. Install the supplied network card into a free PCI-Express-slot of the PC and close the housing. Make sure that you are grounded, and no electrostatic discharge can occur.

3.5 Installation of CONAXX 2

Install the supplied CONAXX 2 software. Make sure that the item "RAPIXX 4336M1F/-M2F ES CC" or „RAPIXX 4343M1F/-M2F ES CC" is selected in the drivers.

Detailed information about the CONAXX 2 installation can be taken from the document "CONAXX 2 Installation Manual".

3.6 Set-up the network

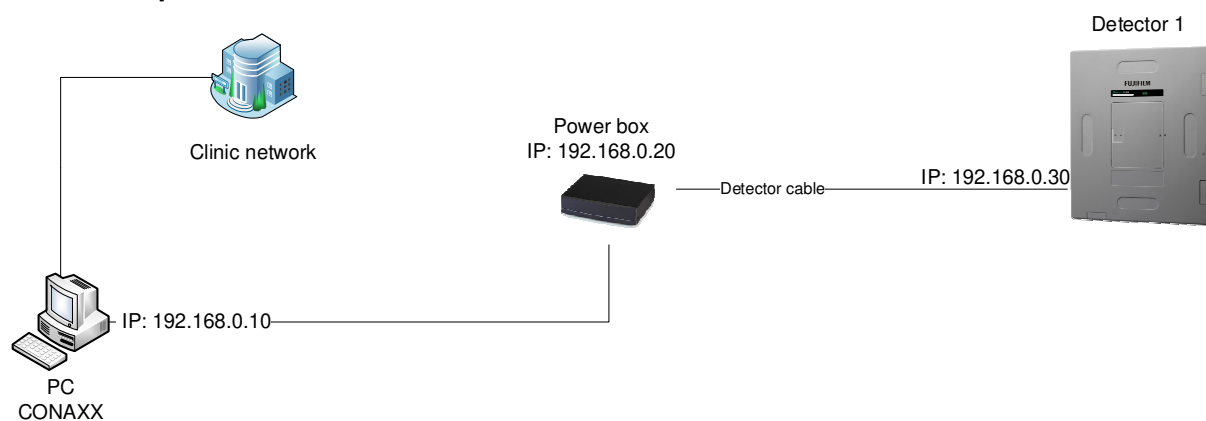

Using dual panel:

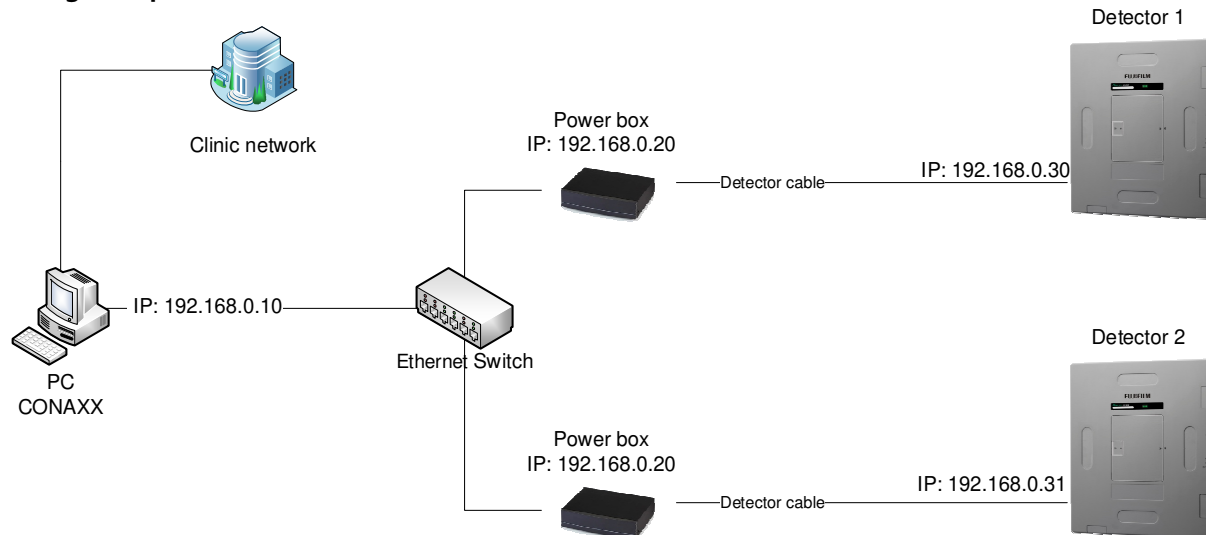

Open the "WINDOWS CONTROL PANEL", open "NETWORK AND SHARING CENTER" and afterwards "CHANGE ADAPTER SETTINGS". Rename the adapter for the clinic network to "eth0". Rename the adapter which is connected to the power box or switch to "eth1".

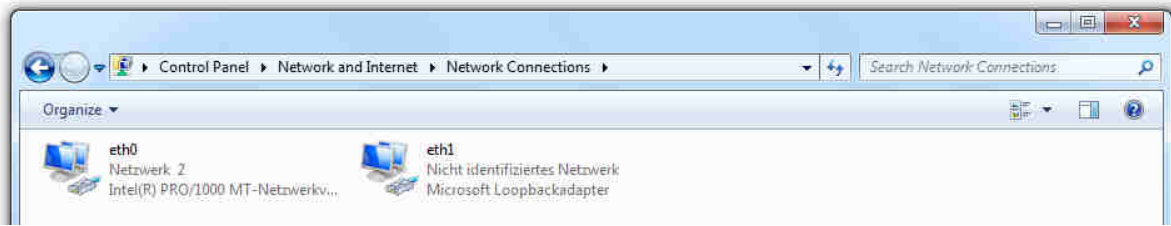

Adjust the network configuration of the computer that you can access the detector. Select the network adapter "eth1" with the right mouse button and open "PROPERTIES". Select the list entry "INTERNET PROTOCOL VERSION 4 (TCP/IPV4)" and open "PROPERTIES". Set up the IP address 192 . 168 . 0 . 10. Change the subnet mask to 255 . 255 . 255 . 0.

The setup of the network adapter is now complete.

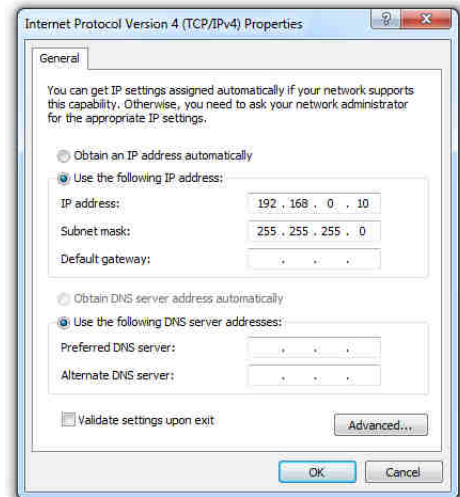

NOTE

Please make sure that the clinic network is not in the IP-address range 192 . 168 . 0 . *.

3.7 Change Windows Settings

3.7.1 User Account Control Deactivation

Go to the "CONTROL PANEL", open "USER ACCOUNTS" and select "CHANGE USER ACCOUNT CONTROL SETTINGS".

Deactivate the User Account Control by moving the slider to the bottom. Confirm the change via "OK".

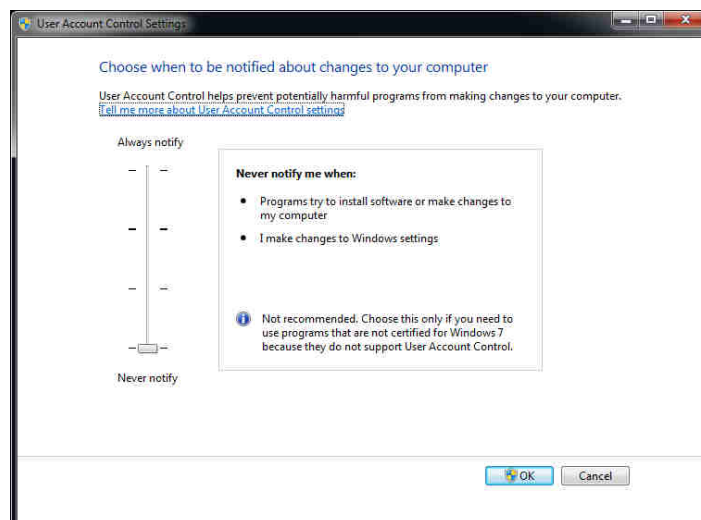

3.7.2 Activate Windows features

Go to the "CONTROL PANEL", open "PROGRAMS AND FEATURES" and select "TURN WINDOWS FEATURES ON OR OFF".

Select in the section "INTERNET INFORMATION SERVICES" all sub-items of "FTP Server" and "WEB MANAGEMENT TOOLS". Confirm the change via "OK".

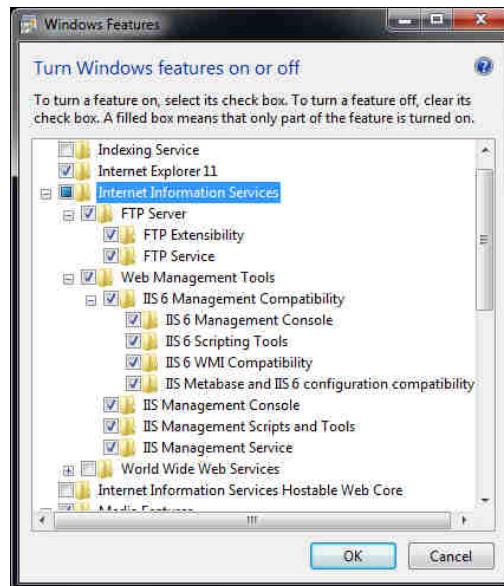

3.7.3 Windows Firewall Customization

In case of using the Windows Firewall, you have to activate a firewall rule. Go to the "CONTROL PANEL", open "WINDOWS FIREWALL" and select "ADVANCED SETTINGS".

Activate the rule "FTP SERVER PASSIVE (FTP PASSIVE TRAFFIC-IN)" in the section "INBOUND RULES" by using the context menu.

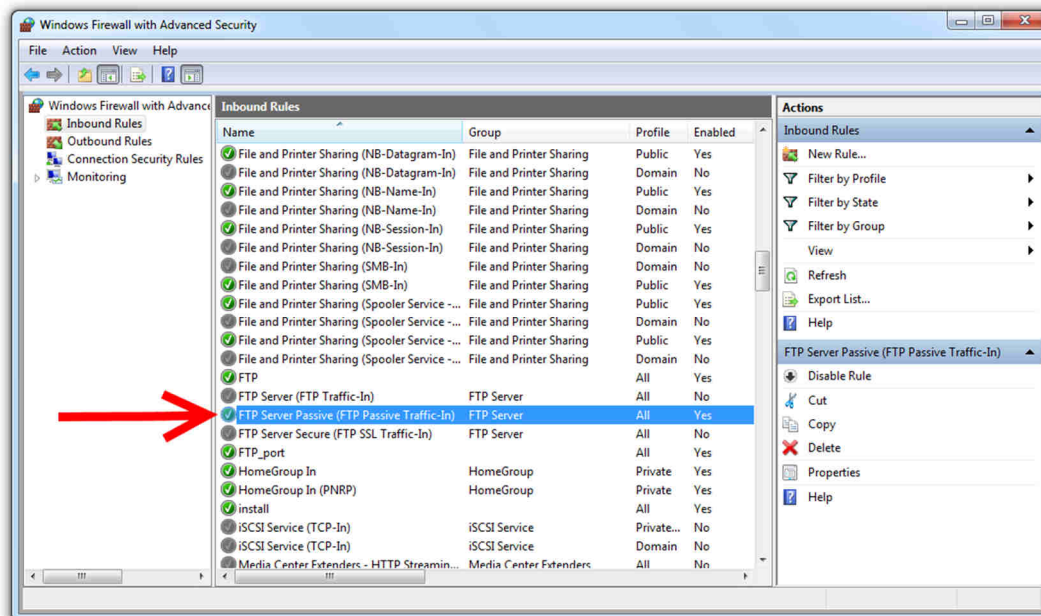

3.8 Installation of the Detector DVD

Insert the Detector DVD into the disc drive (e.g., D:) and start the setup process:

For Windows 32bit: `D:\Installer\x86\setup.exe`

For Windows 64bit: `D:\Installer\x64\setup.exe`

Please follow the screen instruction and restart the computer afterwards.

3.9 User Group Customization

The installation of the detector DVD creates a new Windows user with the designation „DR-ID1200“. This user must be assigned to the „ADMINISTRATION“ user group afterwards.

Go to the “CONTROL PANEL”, open “ADMINISTRATION” and open “COMPUTER ADMINISTRATION”. In the “COMPUTER ADMINISTRATION (LOCAL)” section, select “SYSTEM > LOCAL USER AND GROUPS > USERS”. Double-click on “DR-ID1200” to open the “PROPERTIES” window. In the “MEMBER OF” tab, the “ADMINISTRATORS” group must be removed. The user group “ADMINISTRATORS” can be added afterwards via “ADD...”. Confirm the property change via “OK” and close the “COMPUTER ADMINISTRATION”.

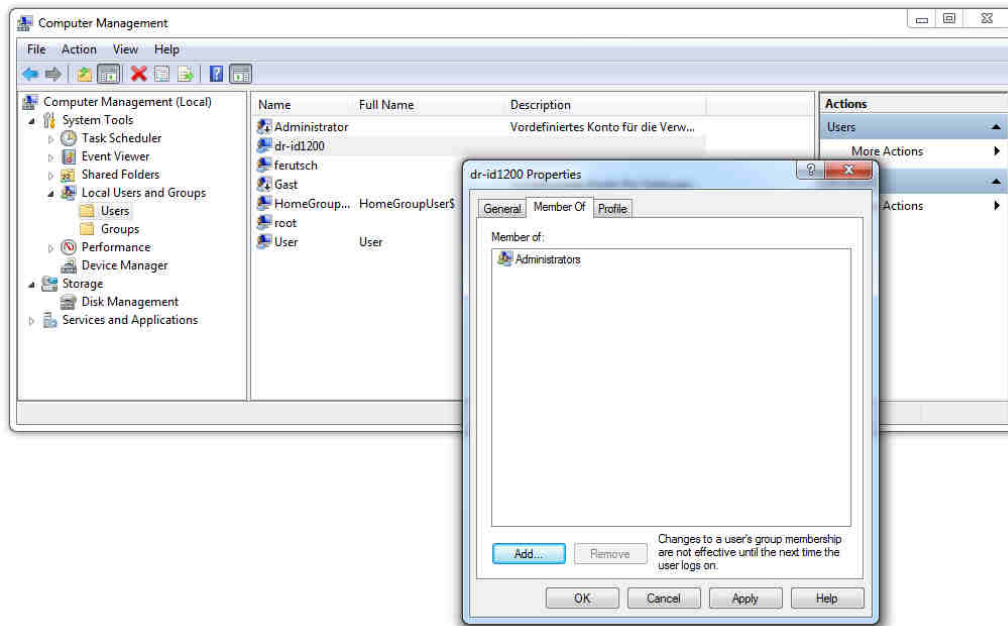

3.10 Configuration of the detector

To configure the detector, the detector must be connected via the detector cable (Starter Kit).

Start the “RAPIXX CONFIGURATION” from the start menu folder “CONAXX2\DR-PANEL”. Click “INITIALIZE” to initialize the configuration.

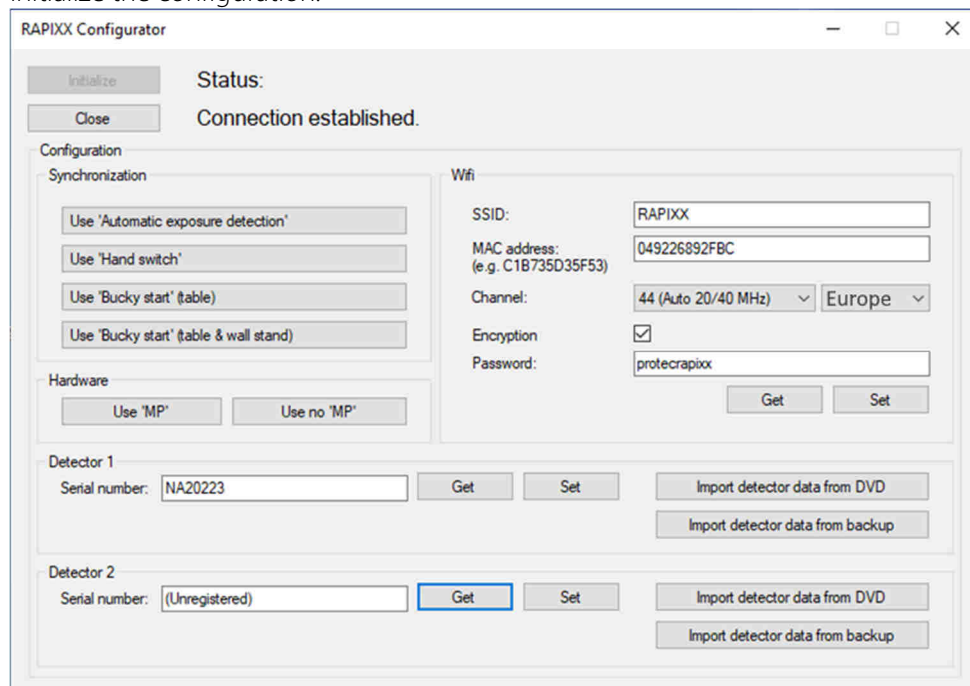

3.10.1 Synchronization

Subsequently, the type of synchronization (automatic exposure detection, hand switch or Bucky Start signal) between detector and X-ray generator must be selected in the "SYNCHRONIZATION" section.

3.10.2 Hardware

Select "USE NO 'MP'" in the section "HARDWARE".

3.10.3 Wifi

Hint:

The country code must also be set correctly in the "Channel" field for wired detectors.

3.10.4 Register the Detector

To register the detector, the serial number (e.g., G221038) must be entered in the "DETECTOR 1" section and confirmed with "SET". The serial number can be found on the detector DVD label. The serial number can be checked via "GET". When using two detectors, the second detector must be registered in the "DETECTOR 2" section.

Afterwards the detector-specific data must be imported from the detector DVD. This is done via "IMPORT DETECTOR DATA FROM DVD". In the following window, the drive in which the detector DVD was inserted must be selected. Using the "IMPORT DETECTOR DATA FROM BACKUP" function, a previously created backup of the calibration data can be imported.

The configuration of the detector is now completed and the program "RAPIXX CONFIGURATION" can be closed.

3.11 First start of CONAXX 2

Start CONAXX 2 with a double click on the desktop icon. Check the document "CONAXX 2 User Manual" for more details.

3.11.1 Necessary settings in CONAXX 2

After the first start of CONAXX 2 open the configuration by clicking the button "Configuration" in the start menu of CONAXX 2 and change into the section "System > Modality".

Select in the area "Selected Modality" the detector that you would like to use, e.g., "RAPIXX 4336 M1F ES CC".

Depending on how the detector is built-in it might be necessary to rotate the acquired images in CONAXX 2. This can be changed in "Rotations" settings.

Afterwards restart CONAXX 2.

3.11.2 Licensing of CONAXX 2

After the restart of CONAXX 2 you will be informed that the license does not fit to your system.

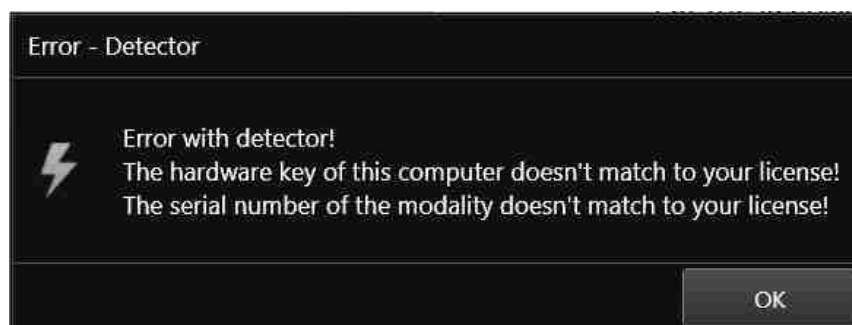

Confirm this message.

**NOTE**

For the licensing procedure it is necessary that CONAXX 2 can communicate with the connected detector. Please do not change the system configuration (network card, connected detectors, ...) otherwise the license may become invalid. In case of using more than one detector please connect all detectors to the computer.

Open the configuration of CONAXX and navigate to the "SYSTEM > REGISTRATION" section to create the license request. In the section "GENERATE HARDWARE KEY" select the function "SAVE KEY AS..." to create a license request. In the next step please choose the type of licensing.

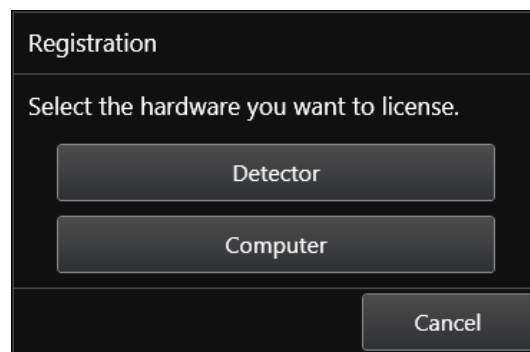

Two different types of licensing are supported:

Type of licensing	Properties
Detector-based	This type links the license with the detector.
Computer-based	This type links the license with the computer.

If no selection option appears, the detector only supports computer-based licensing.

**NOTE**

The module "Advanced image processing (AIP)" is generally linked to the computer. It is not possible to use it on other computers, even if the detector-based licensing is used.

There are two ways to send the hardware key:

1. Online with the licensing page of the dealer backroom or
2. by E-mail

For the online licensing, please login to the backroom and navigate to the page "LICENSING". Select the desired license and upload the hardware key with the function "SET". Download the license afterwards with "GET".

For the licensing by E-mail, send the hardware key to mis@protec-med.com. You will then get the valid license key by E-mail.

This license file must be imported in the section "SYSTEM > REGISTRATION" of the CONAXX 2 configuration.

Afterwards restart CONAXX 2. CONAXX 2 is now operational. The process with the DR-system is described in the document "CONAXX 2 User Manual".

**NOTE**

For detailed information on CONAXX 2 licensing please refer to the document "CONAXX 2 User Manual".

3.11.3 Activation of CONAXX 2 Modules

After licensing, make sure that the CONAXX 2 modules you purchased are activated.

For example:

- Advanced image processing (AIP)
- Grid suppression (optional)
- Diagnostic Viewer (optional)
- DICOM Worklist (optional)
- ...

For detailed descriptions of the modules, please refer to the CONAXX 2 User Manual.

3.12 Dose indicator settings for detector

For each detector the document "RAPIXX calibration values" is included. Follow the instructions in the document to setup the dose indicator.

4 Calibration of the DR-System



NOTE

For the calibration make sure that the detector runs at least 2 hours.

General notes for calibration:

- Set the required SID of the detector manufacturer to 180 cm.
- Make sure that the exposure duration is smaller than 200ms.
- Make sure that the detector is completely irradiated (no collimation).
- Ensure that there are no objects or dirt in the beam path.
- Calibrate on the table.
- Perform a gain calibration every 6 months.

Go to "START MENU" and open in the folder "CONAXX2\DR-PANEL" the program "RAPIXX CALIBRATION". Make sure that you configured and established the detector connection in CONAXX 2 successfully.

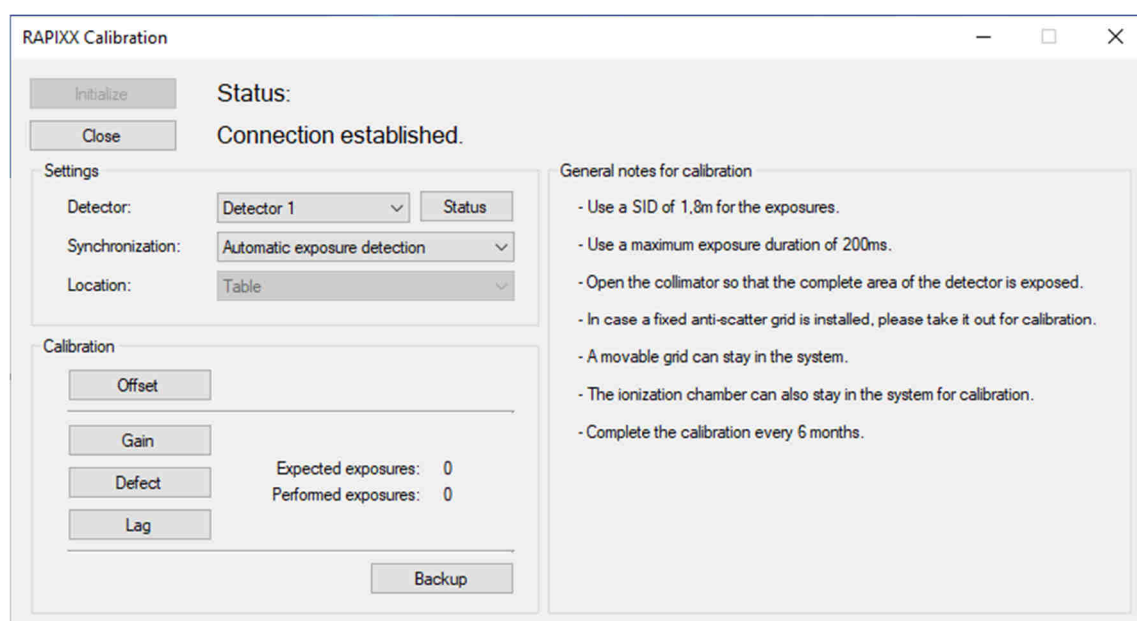



Click "INITIALIZE" to establish the connection to the detector. Subsequently, the desired „DETECTOR“ and the type of synchronization and the exposure location ("SYNCHRONIZATION" and "LOCATION") must be selected in the "SETTINGS" section.

The four different calibrations are started in the "CALIBRATION" section and must be performed according to the dose specifications below. provides four different calibration types. Perform all types according to following exposure specifications.



NOTE

The X-ray parameter mAs is only a suggestion and can differ at each X-ray system. Important is the received dose (μGy), which should be checked with a measuring device before calibration if necessary.

Calibration	Exposures	X-ray parameters			Received dose (μGy)
		kV	mAs	Focus	
„OFFSET“	0	-	-	-	-
„GAIN“	16	75	6.4		89
„DEFECT“	5	75	3.2		44
„LAG“	1	80	50		810

To save calibration, the “BACKUP” function can be used.

The “RAPIXX CALIBRATION” software can now be closed via “CLOSE”.





NOTE

If problems occur during the calibration of the detector, please calibrate according to the supplied instructions of the detector manufacturer.

5 Control Elements and Displays

5.1 Control Elements and Displays of the Detector

LED	Status	Description
POWER (blue) 	On	Detector on
	Flashing	-
	Off	Detector off
READY (green) 	On	Exposure possible
	Flashing	Exposure in progress
	Off	Standby
ERROR (orange) 	On	Communication error
	Flashing	Hardware error
	Off	No error

5.2 Control Elements and Displays of the CONAXX 2 Acquisition Software

This area provides status information and tools for various components in the CONAXX 2 main window:



- **System:**
This function shows status information of the system.
This includes, for example, information about hard disk capacities.



- **Modality:**
This function opens the toolbox for the connected modality.
It provides functions to recover or close the connection to the modality or calibration functions.



- **X-ray generator:**
This function opens the x-ray generator control.
X-ray exposures can be made without taking images via the modality.

For detailed information of the CONAXX 2 acquisition software, please refer to the CONAXX 2 User Manual.

6 Handling

6.1 Requirements before and during Operation

It must be ensured that the surfaces in contact with patients are disinfected before the X-ray examination of each patient (see chapter 7.3.2).



WARNING!

In the event of a technically incorrect image acquisition (e.g., missing image content, strip structures), the entire X-ray system must be restarted and a test exposure must be taken without patient. Only if the exposure is correct, the system can be used again properly. If the test exposure is still defective, please contact PROTEC customer service or a service authorized by them.

6.2 Operation

6.2.1 Start-up order for daily use

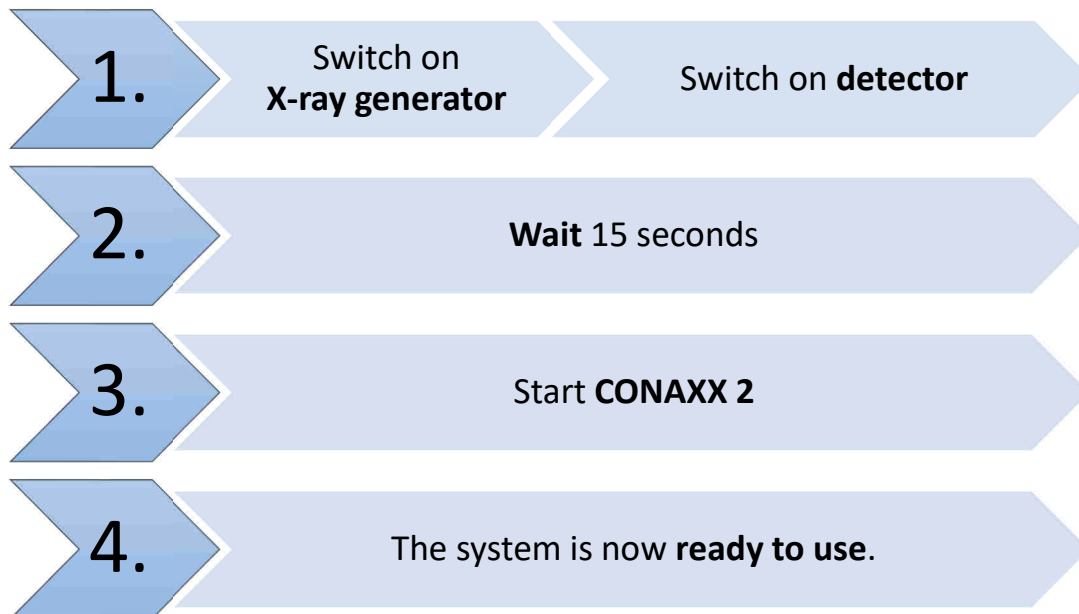

If CONAXX 2 cannot connect to the modality or generator after launching the program, there will appear an error message. In this case, CONAXX 2 must be restarted to initiate a new connection attempt.

More detailed information can be taken from the error message displayed by CONAXX 2.

If no error message appears after starting the program, the connection was established successfully and the system can be used.

6.2.2 Operation of the CONAXX 2 acquisition software

For detailed information of the CONAXX 2 acquisition software, please refer to the CONAXX 2 User Manual.

6.2.3 Operation of the detector with accessories

For detailed information of the detector, please refer to the enclosed original instructions of the detector manufacturer

6.3 Function of the digital X-ray detector system

6.3.1 Switching the RAPIXX DR-System on

The digital X-ray detector system is first switched on by switching on the detector. This is done by plugging the power cable to the power box, which is connected to the detector and switches on automatically. After waiting 15 seconds, the CONAXX 2 acquisition software can be started by double-clicking on the desktop icon.

6.3.2 Switching the RAPIXX DR-System off

To shut down the system, the following components must be switched off one after another.

1. Detector

The detector can be switched off by plugging out the power cable from the power box, which is connected to the detector.

2. CONAXX 2 software

The software can be shut down via the "Exit" menu item in the main menu.

6.3.3 X-ray generator errors during operation

If an error occurs with the X-ray generator during daily operation, the error message provides information on how to solve the problem.

If the connection to the X-ray generator is interrupted during operation with CONAXX 2, it must be restarted. A new connection attempt is not initiated until the restart. If no error message appears during the restart, the connection was established correctly and the generator can be used.

6.3.4 Modality errors during operation

If an error occurs with the modality during daily operation (e.g., communication error, power blackout), the error message provides information on how to solve the problem.

If the connection to the modality is interrupted during the runtime of CONAXX 2, CONAXX 2 must be restarted. A new connection attempt is not initiated until the restart. If no error message appears after the restart, the connection has been established successfully and the modality can be used.

7 Safety and Maintenance



WARNING!

Caution, risk of electric shock!

Switch off the RAPIXX DR-system before cleaning or disinfecting. This disconnects the digital X-ray detector system from the power source and avoids the risk of electric shock.

7.1 Introduction

In this chapter you will find information about safety and maintenance that are necessary to ensure the correct and reliable function of the device after installation.

7.2 Reusability

The RAPIXX DR-system can be reused without any special preparation procedures.

However, it must be ensured that the surfaces in contact with patients are disinfected before the X-ray examination of each patient (see also chapter 6.1).

The RAPIXX DR-system must no longer be used with patients if it shows signs of wear (e.g., metal abrasion, wear of insulations) or dangerous technical defects (e.g., missing, defective or bent parts) or if the resulting image quality (e.g., artifacts in the image) is insufficient.

In this case, please contact PROTEC service department or a service company authorized by them immediately.

7.3 Cleaning and Disinfection



WARNING!

Make sure that no liquid enters the interior of the housing during cleaning and disinfection in order to prevent electrical short circuits and/or corrosion.



CAUTION!

Possible material changes!

Do not use any corrosive, solvent or abrasive cleaning agents that may damage the surface of the device or the coating.

Do not use an excessive amount of ethanol (or neutral cleaner), to prevent liquids from the surface from entering the inside of the detector or its accessories. This will prevent damage and peeling of labels on the detector or its accessories.

Do not use a solvent such as thinners or benzine, as it reacts with the surface of the detector.

Never immerse or flood any parts during cleaning.

7.3.1 Cleaning

The cleaning of the digital X-ray system is very easy due to the very good quality surface coating. This is usually only done with a soft dry cloth.

Do not use corrosive, dissolving or abrasive cleaning agents, which could damage the device surfaces or the coating.

To clean the detector and its accessories, we recommend using cleaning agents that evaporate quickly and therefore prevent liquids from entering inside of the housing.

Commercially available medical rapid disinfection wipes (e.g., Dr. Schumacher Descosept Sensitive Wipes) can be used.

If ready-to-use cloths are not used, cloths lightly soaked with neutral cleaner can be used. These must be carefully wrung out that no liquids from the surface can enter the interior of the detector or its accessories.

Detailed instructions can be found in the enclosed original instructions for the system components.

7.3.2 Disinfection

The disinfection must be performed in accordance with the current applicable legal requirements and guidelines corresponding for disinfection and explosion protection.

For disinfection of surfaces in contact with patients, we recommend commercially available medical rapid disinfection wipes (e.g., Dr. Schumacher Descosept Sensitive Wipes).



WARNING!

No highly flammable disinfectants may be used! For safety reasons, spray disinfection must not be carried out, as the spray mist could penetrate the device and cause short circuits or corrosion.

If disinfectants are used that can form explosive gas mixtures, the device may only be switched on again when the gas mixtures have evaporated!

Detailed instructions can be found in the enclosed original instructions for the system components.

7.4 Inspection and Maintenance



WARNING!

No maintenance or repair work may be performed while the digital X-ray detector system is being used with a patient!

All maintenance and repair work may only be performed by personnel trained or authorized by PROTEC.

7.4.1 Daily Monitoring before and during the Examination Operation

The detector surface must be daily checked before operating start if there are any visible damages. In case of visible damages, a technical homogeneity X-ray (without any patient) should be taken to check if they are visible inside the image.

For detailed instructions, refer to the enclosed original manuals for the system components.

7.4.2 Regular Monitoring

In the interest of the safety of the patient, operator and external third parties, checks that maintain the operational safety and functionality of the device are required to be undertaken in regular 12 months intervals by the PROTEC service department or a PROTEC authorized service technician. This includes the control of the image quality as well.

It is recommended to calibrate the digital X-ray detector system every 6 months at least.

Detailed instructions can be found in the enclosed original manuals of the system components.

7.4.3 Maintenance

The required maintenance must be carried out by PROTEC service department or a service company authorized by them in order to ensure the safe and reliable functionality of the device. The maintenance intervals depend on the frequency of use. Prior to the examination operation, the user must satisfy himself that all appliances listed in the operating instructions and serving safety are in working order and that the RAPIXX DR-system is ready for operation.

Detailed instructions can be found in the enclosed original manuals of the system components.

**WARNING**

Wear parts must be replaced with original parts.

**NOTE**

In the case that the required maintenance is not completed as intended, PROTEC X-ray Systems GmbH is no longer responsible for injuries to the operator and third parties, provided that the damage is the result of improper or missing maintenance.

7.4.4 Warranty**NOTE**

The current warranty conditions can be found in your order documents.

Repairs and spare parts in the event of improper use are also excluded.
Warranty work may only be carried out by trained specialists.

7.4.5 Product Service Life

Detailed information on the product service life can be found in the enclosed original instructions for the system components. After the product has reached the end of its service life, further use is at your own risk.

7.4.6 Further Information

Detailed information and further descriptions for "Safety and Maintenance" of the detector can be found in the enclosed original manual of the detector manufacturer.

7.4.7 Applied Parts and Parts Considered as Applied Parts

Part	Definition (Applied part or part that is treated like an applied part but is not defined as an applied part)
Detector	Applied part type B

7.4.8 Disposal Notes

The digital X-ray detector system contains various plastics, chemical elements and heavy metal. When disposing exchange and spare parts, or if necessary, the entire device, the valid rules and regulations must be observed. Please contact your contractual partner or service company or commission a company specialized in disposing the respective components.

8 Power Supply



WARNING!

To avoid the risk of an electric shock, this device may only be connected to a supply network with a protective earth conductor.

8.1 Electromagnetic Compatibility (EMC) according to EN 60601-1-2



CAUTION!

As a medical electrical device, the components of the RAPIXX DR-system are subject to special precautionary measures regarding EMC and must be installed and commissioned in accordance with the EMC information contained in the accompanying documents.



CAUTION!

Portable RF communication devices (radio devices) should not be used closer than 30 cm (12 in) to the marked parts and cables of the digital X-ray detector system. Failure to observe can lead to a reduction in the performance characteristics of the device.

For information on the electromagnetic compatibility of the detector and its accessories, refer to the enclosed original instructions of the detector manufacturer.

9 Technical Data

9.1 Dimensions Detector

Dimension (L x W x H):

4336M1F ES CC / 4336M2F ES CC: 460 mm x 384 mm x 15 mm

4343M1F ES CC / 4343M2F ES CC: 460 mm x 460 mm x 15 mm

Effective area:

4336M1F ES CC / 4336M2F ES CC: 425,4 mm x 350,4 mm

4343M1F ES CC / 4343M2F ES CC: 425,4 mm x 424,8 mm

Front side (active side)

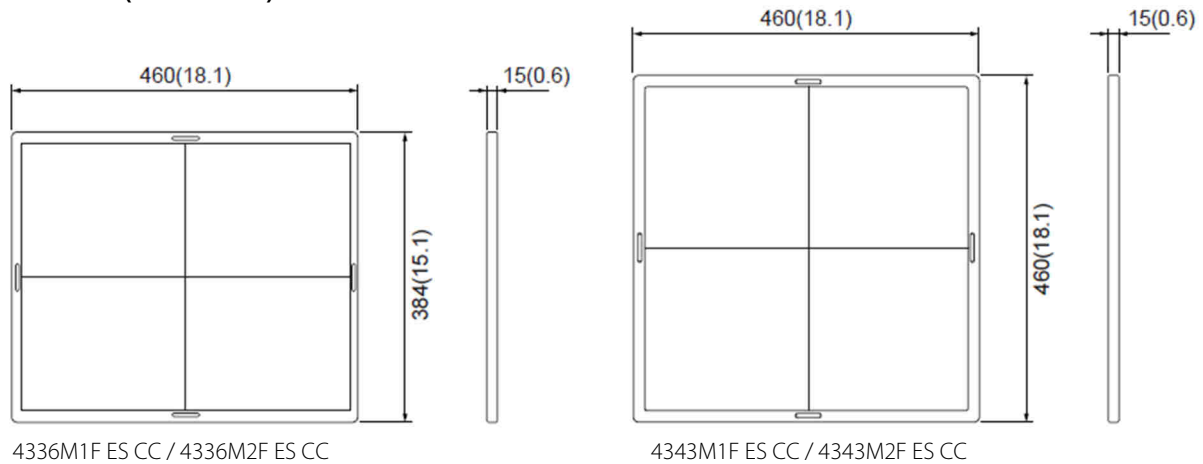

9.2 Technical Data Detector

	4336	4343
Resolution	150 μm	
Scintillator	CsI (M1F) / GOS (M2F)	
Effective area	425,4 mm x 350,4 mm	425,4 mm x 424,8 mm
Uniform load	300 kg	
Protection class	IPX3	
Punctual load	120 kg on an area with 4 cm diameter	
Weight	ca. 2.65 kg	ca. 3.35 kg

For information of the detector and its accessories, refer to the enclosed original instructions of the detector manufacturer.

9.3 Protection Type and Protection Class

For detailed instructions on the protection type and protection class, refer to the enclosed original instructions for the system components.

9.4 Automatic Cut-off dose

The recommended automatic cut-off dose on the X-ray system with the digital X-ray detector system is 2.5 μGy for CsI-scintillators and 2.9 μGy for GOS-scintillators.

9.5 Environmental Conditions

9.5.1 Environmental Conditions during Operation

Ambient temperature	+15°C to +35°C
Relative humidity	15% to 80%
Atmospheric pressure	700 hPa to 1060 hPa

9.5.2 Environmental Conditions for Shipping and Storage

Ambient Temperature	-30°C to +50°C
Relative humidity	10% to 90%
Atmospheric pressure	700 hPa to 1060 hPa































CAUTION!

If the detector is used under high temperature conditions for a long period of time, this could lead to image artifacts or failure of the device.

10 Description of Symbols, Labels and Abbreviations

10.1 Symbols

	Atmospheric pressure limit
	Temperature limit
	Humidity limit
	Keep dry
	Protect from sunlight
	Fragile, handle with care
	Handle with care
	Full load
	Caution with local load / Do not drop the detector on the user/patient
IPxx	Protection type
	This way up
	Attention, observe accompanying documents
	Refer to Instructions for use
CE	CE-certification, with number of notified body if applicable
	Manufacturer

	Medical Device
	Order reference
	Serial number
	Unique Device Identification
	Production date
	Classification according to EN 60601-1 (type B applied part)
 www.protec-med.com/download	This symbol indicates the need to observe the instructions for use. This is provided in an electronic format (eIFU) on our website.
	Disposal instructions; WEEE (Waste of Electrical and Electronic Equipment)
	Protective earthing
	Power supply (detector)
	Ready (detector)
	Error (detector)
	System (CONAXX 2)
	Modality (CONAXX 2)
	X-ray generator (CONAXX 2)

10.2 Type Label

10.2.1 RAPIXX DR-System

REF 4999-9-0000_V008
SN SNxxxxxx
 2025-07-11
RAPIXX DR-System
4336M1F ES CC Set
 Diagnostic X-ray digital imaging conversion system
 Person responsible for combining devices to this system according to Regulation (EU) 2017/745, Article 22
 www.protec-med.com/download
 PROTEC X-ray Systems GmbH
 In den Dorfriesen 14
 71720 Oberstenfeld
 Germany
 UDI (01)04260502643587
 (11)250711
 (21)SNxxxxxx
 TL4999-9-0000V03
 Please note the original manufacturer information!
 Bitte original Herstellerangaben beachten!

Example Type Label RAPIXX DR-System

combined by:
 PROTEC X-ray Systems GmbH
 In den Dorfriesen 14
 71720 Oberstenfeld
 Germany
Component of
REF 4999-9-0000_V008
 RAPIXX DR-System
 4336M1F ES CC Set
 AL4999-9-0000V03

Example component RAPIXX DR-System

10.2.2 Detector

Manufacturer **FUJIFILM Corporation** 26-30, NISHIAZABU 2-CHOME, MINATO-KU, TOKYO 106-8620 JAPAN
 MADE IN TAIWAN
DIGITAL RADIOGRAPHY DR-ID1270
FLAT PANEL SENSOR DR-ID1273SE
 6-12V === 2.73A
 MAX 300kg / 660lb
 CLASSIFIED C UL US
 MEDICAL - GENERAL MEDICAL EQUIPMENT AS TO ELECTRICAL SHOCK, FIRE AND MECHANICAL HAZARDS ONLY. ACCORDING TO IEC60601-1:2012 TYPE B. CANADA: CUL-13886. CHINA: N1, 13886.

Example type label FUJIFILM DR-ID 1273SE detector

10.2.3 Power Box of the Detector

Manufacturer **FUJIFILM Corporation** 26-30, NISHIAZABU 2-CHOME, MINATO-KU, TOKYO 106-8620, JAPAN
DR-ID 1200PB
 MADE IN JAPAN 405N200057
DR-ID 1200PB
 CLASSIFIED C UL US
 MEDICAL - GENERAL MEDICAL EQUIPMENT AS TO ELECTRICAL SHOCK, FIRE AND MECHANICAL HAZARDS ONLY. ACCORDING TO IEC60601-1:2012 TYPE B. CANADA: CUL-13886. CHINA: N1, 13886.
 50-60Hz
 100-240 V ~
 2-0.84 A
SN
 MADE IN JAPAN 405N120962

Example Type Label FUJIFILM Power Box

10.2.4 INTERFACE BOX

MD
REF 4499-9-5001
SN SNxxxxxx
 2025-07-09
INTERFACE BOX
 PROTEC X-ray Systems GmbH
 In den Dorfriesen 14
 71720 Oberstenfeld
 Germany
 UDI (01)04260502642429
 (11)250709
 (21)SNxxxxxx
 TL4499-9-5001V05
 POWER RATING
 24 V ===
 10 W
 CE
 +40°C 1060 hPa 75%
 +10°C 700 hPa 35%

Example type label INTERFACE BOX

10.2.5 CONAXX 2



Example type label CONAXX 2

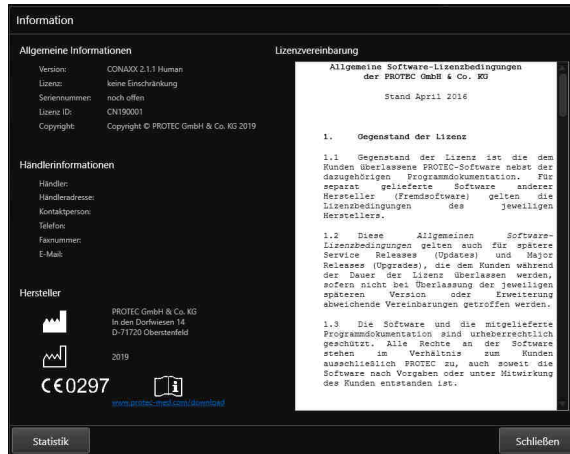

Example specification in the CONAXX 2 interface

10.3 Positions of the Signs and Labels

10.3.1 Detector

Flat panel sensor (DR-ID1273SE)

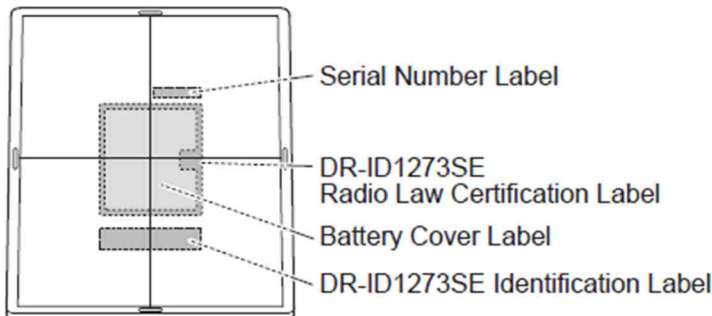

The type labels are located on the underside of the detector.

10.3.2 INTERFACE BOX



The type labels are located on the underside of the INTERFACE BOX.

10.4 Abbreviations

mm	Millimeter
cm	Centimeter
m	Meter
µm	Micrometer
µGy	Microgray
kg	Kilogram
°C	Degree - Celsius
hPa	Hectopascal
DIN	German Industry Standard
EN	European Standard
CE	CE-Mark
Hz	Hertz
A	Ampere
SN	Serial number
EMC	Electromagnetic compatibility
HF	High frequency
LP/mm	Line pairs per millimeter
CsI	Cesium iodide
IP	International Protection