

RAPIXX DR-System 12043M1i WiFi Set

Digital X-ray detector system

Model/ID: 4999-9-0000_Vxxx
Basis UDI-DI: 426050264D001UX

Instructions for Use & Installation Manual

ID no. 5526-0-9004

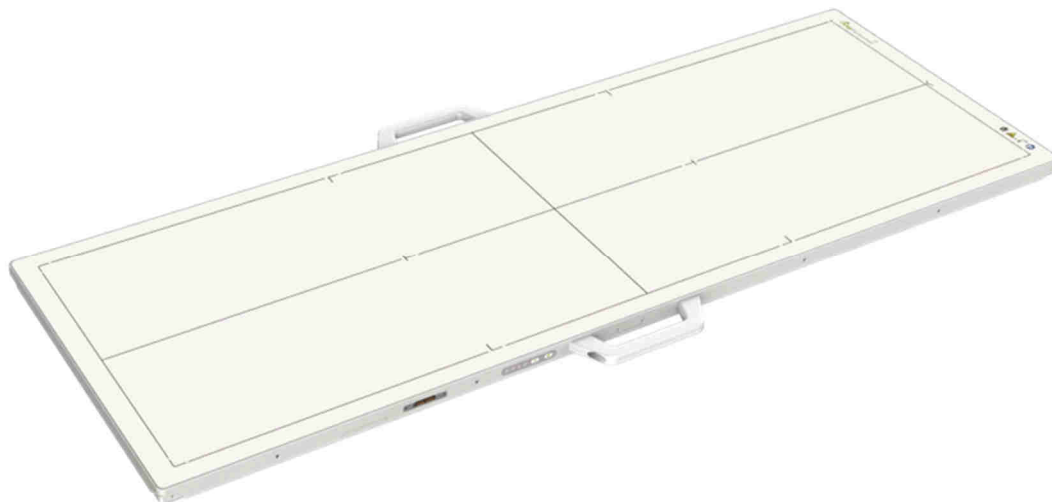

Responsible for assembling
of products to this system
according to Article 22 of Regulation (EU) 2017/745:

PROTEC X-ray Systems GmbH
In den Dorfwiesen 14, 71720 Oberstenfeld, Germany
Phone: +49 (0) 7062/92 55-0 E-mail: protec@protec-med.com

Version: 2.0
Issued: 2025-07-18
Subject to alterations



NOTE

All sheets of this document contain proprietary and confidential information of PROTEC X-ray Systems GmbH and is intended for exclusive use by current PROTEC X-ray Systems GmbH customers. Copying, disclosure to others or other use is prohibited without the express written consent of PROTEC's law department. Knowledge of violations of these regulations must be reported immediately to PROTEC X-ray Systems GmbH.

© 2025 PROTEC X-ray Systems GmbH, Oberstenfeld

Comments and questions about the documentation, please contact:

PROTEC X-ray Systems GmbH

In den Dorfwiesen 14 | 71720 Oberstenfeld
Germany

Phone: (+ 49) 7062 – 92 55 0

Fax: (+ 49) 7062 – 92 55 60

E-Mail: protec@protec-med.com

Internet: www.protec-med.com

Table of contents

	Page
Table of contents	3
Revision Status	5
Radiation Warning	6
To the User	6
1 Device Description	7
1.1 Introduction	7
1.2 Description.....	7
1.2.1 System Components	7
1.2.2 Hardware and Network System Requirements	8
1.3 Performance Characteristics	8
1.4 Intended Use	8
1.5 Clinical Benefit	8
1.6 Patient Target Group(s).....	8
1.7 Medical Conditions to be diagnosed.....	8
1.8 Indications and Contraindications	8
1.9 Intended User Group.....	9
1.10 Declaration according to Article 22.....	9
2 Safety Instructions	10
2.1 General Safety Instructions	10
2.1.1 Device Operation	10
2.1.1.1 Operating Type	10
2.1.2 Operating Personnel	10
2.1.3 Explosion Protection	11
2.1.4 Interaction with Other Devices.....	11
2.1.5 Electromagnetic Environment and Influencing of Devices	11
3 Installation	12
3.1 Checklist	13
3.2 Installation of CONAXX 2	13
3.3 Set-up of the network connections	13
3.4 Modification of the X-ray system (trigger mechanism).....	14
3.4.1 Installation with hand switch.....	14
3.5 Connection of the components.....	15
3.5.1 Operation with automatic exposure detection (AED)	15
3.5.2 Operation with INTERFACE BOX	15
3.6 WLAN connection establishment with the detector	16
3.7 First start of CONAXX 2.....	16
3.7.1 Necessary settings in CONAXX 2	16
3.7.2 Licensing of CONAXX 2	17
3.7.3 Activation of CONAXX 2 Modules.....	18
3.8 Dose indicator settings for detector	18
4 Calibration of the DR-System	19
5 Control Elements and Displays	20
5.1 Control Elements and Displays of the Detector	20
5.2 Display Detector Indicators	20
5.2.1 Display Power Supply (A)	20
5.2.2 Display Connection (B)	20
5.2.3 Display Status (C).....	21
5.2.4 Display Mode (D).....	21
5.3 Displays Battery Charging Station.....	21
5.4 Control Elements and Displays of the CONAXX 2 Acquisition Software.....	22
6 Handling	23
6.1 Requirements before and during Operation.....	23

6.2	Operation.....	23
6.2.1	Start-up order for daily use.....	23
6.2.2	Operation of the CONAXX 2 acquisition software.....	23
6.2.3	Operation of the detector with accessories	24
6.2.3.1	Battery handling and battery changing.....	24
6.3	Function of the digital X-ray detector system	24
6.3.1	Switching on the RAPIXX DR system	24
6.3.2	Switching off the RAPIXX DR system	24
6.3.3	Switch-on order for battery changing	25
6.3.4	Troubleshooting while connection establishment.....	25
6.3.5	X-ray generator errors during operation	25
6.3.6	Modality errors during operation	26
6.3.7	Positioning the organ when using automatic exposure detection (AED).....	27
7	Safety and Maintenance.....	28
7.1	Introduction	28
7.2	Reusability	28
7.3	Cleaning and Disinfection	28
7.3.1	Cleaning.....	28
7.3.2	Disinfection.....	29
7.4	Inspection and Maintenance.....	29
7.4.1	Daily Monitoring before and during the Examination Operation.....	29
7.4.2	Regular Monitoring.....	29
7.4.3	Maintenance	29
7.4.4	Warranty.....	30
7.4.5	Product Service Life	30
7.4.6	Further Information	30
7.4.7	Applied Parts and Parts Considered as Applied Parts.....	30
7.4.8	Disposal Notes	30
8	Power Supply	31
8.1	Electromagnetic Compatibility (EMC) according to EN 60601-1-2	31
9	Technical Data.....	32
9.1	Dimensions Detector	32
9.2	Technical Data Detector.....	32
9.3	Protection Type and Protection Class.....	33
9.4	Automatic Cut-off dose	33
9.5	Environmental Conditions	33
9.5.1	Environmental Conditions during Operation.....	33
9.5.2	Environmental Conditions for Shipping and Storage	33
10	Description of Symbols, Labels and Abbreviations.....	34
10.1	Symbols	34
10.2	Type Labels.....	35
10.2.1	RAPIXX DR-System.....	35
10.2.2	Detector.....	36
10.2.3	Battery charging station (charger) and detector battery.....	36
10.2.4	INTERFACE BOX	37
10.2.5	CONAXX 2.....	37
10.3	Labels	37
10.3.1	Detector.....	37
10.4	Positions of the Signs and Labels.....	37
10.4.1	Detector.....	37
10.4.2	Battery charging station.....	38
10.4.3	Battery	38
10.4.4	INTERFACE BOX	38
10.5	Abbreviations.....	39

**NOTE**

The information contained in these instructions for use conforms to the configuration of the system equipment as of the date of manufacture. Revisions made after the delivery are incorporated in a new version of this document. Current versions of the document can be accessed at any time via the PROTEC website.

Revision Status

Revision	Date	Updated pages	Comments	Author
1.0	2024-10-16	all	Original issue Article 22 system	DP
2.0	2025-07-18	All	First edition PROTEC X-ray Systems GmbH	ML

Radiation Warning



WARNING!

In these accompanying documents, a system or a component for such a system is documented, which is used for the intended generation of X-rays in medical diagnostics.

X-rays are ionizing radiation which can cause damage to living organisms (e.g., cancer or mutations).

X-rays pose a potential risk to patients and employees.

Therefore, the aim of any radiation application and given medical issue is to minimize the radiation exposure for both groups of persons.

The persons responsible for the application must have the necessary expertise in accordance with the regulations and guidelines and apply the procedures for the safe operation of such systems.

National regulations must also be observed during planning and installation.

X-rays are generated in the X-ray tube by strong deceleration of previously accelerated electrons, which emits energy in the form of electromagnetic waves. The intensity depends on the set parameters of voltage (kV), current (mA) and time (s) at the X-ray generator. The X-rays are emitted only at a beam exit window of the tube and are limited by the collimator placed directly below it.

To the User



NOTE

The user of these accompanying documents is required to carefully read through and carefully consider the instructions, warnings and cautions contained therein before starting operation.

Even if you have already operated similar systems, changes in the design, production and functional routine of the system described here may have been made, which have a significant influence on the operation.

Even if the product was the subject of a hazard analysis and the design corresponds to the current state of the art, residual risks remain during clinical use. These are represented in the following instructions for use by limits of use, contraindications, warnings and precautions.

Assembly and service works on the system described here must be carried out by authorised and qualified personnel from PROTEC X-ray Systems GmbH. Assembly personnel and other persons who are not employees of the technical service department of PROTEC X-ray Systems GmbH are requested to contact the local branch of PROTEC X-ray Systems GmbH before assembly or service work is started. For assembly and service works, it is necessary to use the "Technical Description" of the product and to observe the points it contains.

1 Device Description

1.1 Introduction

The instructions for use summarize the most important information for efficient and effective operation of the RAPIXX DR-system.



NOTE

Before working with the RAPIXX DR-system, it is mandatory to read the applicable original manuals for the system components with detailed safety and handling instructions. These documents are leading and valid in their current version.

1.2 Description

The digital X-ray detector systems of the RAPIXX-series are intended for conventional radiography. The detectors of the RAPIXX-set serve as an image receiver that displays X-ray images in digital form on a monitor or display. The CONAXX 2 acquisition software included in the set is responsible for image reception, image processing and image subsequent processing.

The digital X-ray detector systems of the RAPIXX-series are assembled from individual components that are stand-alone medical devices, but which must be interconnected to fulfil their intended purpose.

1.2.1 System Components

The RAPIXX DR system consists of the following system components:

- Detector RAPIXX 12043M1i WiFi
 - Control box
 - Power supply unit for detector
 - Charging station
 - WiFi Adapter
 - Power supply cable
 - LAN cable 15 m
 - 3 batteries
- CONAXX 2 acquisition system software (on data carrier)
- Documentation RAPIXX DR-system (on data carrier)

Optional system components

- Detector Trolley 12043
- INTERFACE BOX (trigger mechanism detector)
- Access Point
- CONAXX 2 Module
 - CONAXX 2 X-Ray Journal
 - CONAXX 2 Gridline Suppression
 - CONAXX 2 DICOM Print
 - CONAXX 2 Generator Connection
 - CONAXX 2 Patient CD
 - CONAXX 2 DICOM Query
 - CONAXX 2 DICOM Worklist
 - CONAXX 2 Diagnostic Viewer
 - CONAXX 2 Dual Panel

Optional accessories

- PC or Notebook

Accessories that can influence the EMC conditions

- Network cable (take note of the max. cable length in the component documents)
- RAPIXX data connection cable (take note of the max. cable length in the component documents)
- WLAN router or Access Point (only use devices approved by PROTEC)

1.2.2 Hardware and Network System Requirements

When using the digital X-ray detector system, it should be ensured that the country-specific requirements for data protection and IT security are met.

The system requirements for the optional system components (RAPIXX-series) can be found in the current document supplied, "EN_5330-0-0026_CONAXX2_System_Requirements".

1.3 Performance Characteristics

See instructions for use of the individual components.

1.4 Intended Use

The RAPIXX-series of digital X-ray detector systems are intended as system components of diagnostic X-ray systems for the acquisition, image processing and data transmission of conventional X-ray images for various routine applications in planar X-ray imaging in human medicine.

RAPIXX DR-systems are not intended for mammography or dental applications.

1.5 Clinical Benefit

The clinical benefit of digital X-ray detector systems in human medicine, in combination with a diagnostic X-ray system, is the generation of conventional two-dimensional X-ray images for creation or specification of findings as a basis for treatment decisions.

In addition, compared to analogue X-ray technology, digital X-ray detector systems have a wider tolerance range of the X-ray dose required for a conventional X-ray image. This wider tolerance range reduces the dose exposure of patients, as equivalent X-ray images can be produced with lower doses and repeat exposures can be avoided.

1.6 Patient Target Group(s)

The intended patient group includes all people for whom a justifying indication for a medical X-ray has been given by a physician with the necessary expertise in radiation protection.

There are no general or fundamental restrictions on the patient group regarding age, gender, origin and patient condition.

1.7 Medical Conditions to be diagnosed

A complete list of medical conditions to be diagnosed is not feasible, as the range of conventional radiographs is very diverse and may also vary in the course of medical-technical progress.

Examples for medical conditions to be diagnosed are:

- Bone fracture or bony injuries of the skeletal system or pathological changes of the bony tissue.
- Control of the correct set-up of the fracture.
- Luxation and bony ligament tears of the musculoskeletal system.
- Degenerative, inflammatory, traumatic and tumorous diseases and changes of the musculoskeletal system.
- Deformities and defective positions of the skeletal system.
- Thoracic and pulmonary symptomatology (thorax exposures).
- Sclerosis.
- Inflammatory and expansive processes of the mucous membrane, craniofacial bones and the expansion of the paranasal sinuses.
- Disease of the abdominal cavity (e.g., acute abdomen, abdominal overview radiograph, urethrogram, cystogram).

1.8 Indications and Contraindications

As standalone products, X-ray detector systems have no intended main effect in or at the human body. Therefore, considered in isolation, no indications or contraindications can be shown for them.

1.9 Intended User Group

RAPIXX DR-systems are intended exclusively for use by professional users who are trained in the operation of diagnostic X-ray systems, in combination with a digital X-ray detector system, in accordance with the respective national regulations and who are familiar with the proper handling, use and operation and also have been instructed in the permitted conjunction with other medical products, objects and accessories.

Appropriate users can be, for example: X-ray technicians, X-ray assistants, medical technical X-ray assistants, surgeons, casualty surgeons, orthopedists and other trained medical personnel.

1.10 Declaration according to Article 22

The declaration according to article 22 of regulation (EU) 2017/745 is available upon request from:

PROTEC X-ray Systems GmbH

In den Dorfwiesen 14 | 71720 Oberstenfeld

Germany

Phone: (+ 49) 7062 – 92 55 0

Fax: (+ 49) 7062 – 92 55 60

E-Mail: protec@protec-med.com

Internet: www.protec-med.com

2 Safety Instructions



NOTE

Contains information that must be observed during operation.

xxx



CAUTION!

Contains information which, if not observed, can cause property damage.

xxx



WARNING!

Contains information which, if not followed, can cause personal injury.

xxx



WARNING!

Warning of radioactive substances or ionizing radiation. Contains information which, if not observed, can cause personal injury.

xxx

Settings and calibrations that are not described in these instructions for use must be carried out using the technical description of the individual components by PROTEC service department or a service company authorized by them.



NOTE

All supplied instructions must be observed and the safety instructions contained therein must be carefully read and adhered to.



CAUTION!

The instructions for use contain all the information relevant to safety in order to generally put the digital X-ray detector system into operation. The device may only be operated by appropriately trained and trained personnel. In this context, operation is ensured by clear symbols on the control elements. All further information and instructions can be found on the supplied data carrier (USB, CD or DVD). This information applies in its entirety as an appendix to these instructions for use and must be observed.

2.1 General Safety Instructions

2.1.1 Device Operation

In case of a malfunction, do not use the digital X-ray detector system anymore and notify PROTEC service department or a service company authorized by them.

2.1.1.1 Operating Type

The digital X-ray detector system is intended for continuous operation.

2.1.2 Operating Personnel



NOTE

Only trained and authorized personnel are allowed to work on the digital X-ray detector system.

**NOTE**

The operating personnel must be familiar with all warning signs attached to the digital X-ray detector system. They are used for your own safety and that of others and ensure proper operation.

2.1.3 Explosion Protection

The digital X-ray detector system is not designated for use within areas with explosive hazards.

2.1.4 Interaction with Other Devices

Interactions with other devices are not known.

2.1.5 Electromagnetic Environment and Influencing of Devices

**CAUTION!**

The use of other accessories, other converters and other cables than those specified by PROTEC or provided in the documentation of the component manufacturer can result in increased electromagnetic interference or reduced electromagnetic immunity of the device and lead to defective operation.

**CAUTION!**

The use of the digital X-ray detector system immediately next to other devices or with other devices in a stacked form should be avoided, as this could result in defective operation. If use in the manner described above is nevertheless necessary, the digital X-ray detector system and the other devices should be observed to ensure that they are working properly.

**NOTE**

The properties of this device, determined by emissions, allow its use in industrial areas and in hospitals (CISPR 11, class A). When used in residential areas (for which class B is usually required by CISPR 11), this device may not provide adequate protection for radio services. The user may need to take remedial measures such as relocating or realigning the device.

The digital X-ray detector system is intended for use in an environment in professional health care facilities (e.g., clinics, surgery centers, physiology practices ...).

3 Installation



NOTE

The installation of the digital X-ray detector system must be performed by PROTEC customer service or a service authorized by it.



CAUTION!

The digital X-ray detector system must not be installed in the following locations to avoid malfunction, damage, fire or injury:

- Where there are large temperature fluctuations.
 - Near heat sources e.g., a heater.
 - In an environment containing salt or sulfur.
 - In the vicinity where water can escape.
 - Where corrosive gas may be generated.
 - In a dusty environment.
 - Where the device is exposed to frequent or excessive vibrations or shocks.
 - Where the device is exposed to direct sunlight.
 - Where the ambient conditions for temperature, humidity and air pressure cannot be maintained.
-

For detailed information, please refer to the installation manuals of the individual components.



NOTE

Use only supplied network cables or well-shielded cables of category CAT6 or higher.



NOTE

The anti-scatter grid recommended for this type of detector depends on factors such as grid motorization. Therefore, the grid to be used should be coordinated with PROTEC X-ray Systems GmbH in advance.



WARNING!

PROTEC X-ray Systems GmbH assumes no liability for the selection of the anti-scatter grid.



WARNING!

If the detector of the RAPIXX DR-system is operated via data cable and with direct patient contact, it must be ensured that the data cable is equipped with a network isolator in accordance with EN 60601-1.

3.1 Checklist

If the installation has already been prepared by PROTEC, only the following subchapters of this chapter need to be observed:

- 3.4 Modification of the X-ray system (trigger mechanism)
- 3.5 Connection of the components

Afterwards continue with the chapter "4. Calibration of the DR-System".

3.2 Installation of CONAXX 2

Install the supplied CONAXX 2 software. Make sure that the item "RAPIXX 12043M1i" is selected in the drivers.

Detailed information about the CONAXX 2 installation can be taken from the document "CONAXX 2 Installation Manual".

3.3 Set-up of the network connections

On delivery, each detector is configured with the IP 192 . 168 . 8 . 8. Please adjust the network configuration on the computer to access the detector. Go to „CONTROL PANEL“, open „NETWORK- AND SHARING CENTER“ and afterwards „CHANGE ADAPTER SETTINGS“.

In case of using an Access Point, select the network adapter where the Access Point is connected with the right mouse button and open „PROPERTIES“.

In case of using the WLAN adapter of the computer for direct contact to the panel, select the WLAN adapter with the right mouse button and open „PROPERTIES“.

Select the „INTERNET PROTOCOL VERSION 4 (TCP/IP)“ entry from the list and click on „PROPERTIES“. The IP-address can be manually entered in the following window. Select the address 192 . 168 . 8 . 188 and set 255 . 255 . 255 . 0 as subnet mask.

The configuration of the network card is now completed.

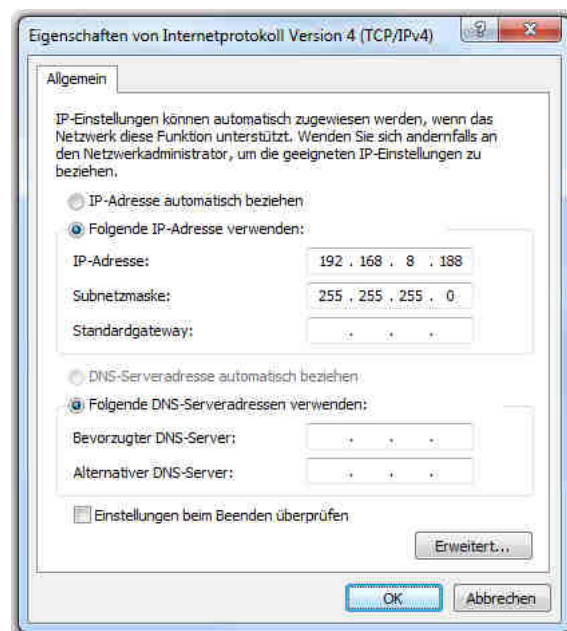

3.4 Modification of the X-ray system (trigger mechanism)

When using the INTERFACE BOX, it must be connected to the X-ray system.

3.4.1 Installation with hand switch

Connect the hand switch and the X-ray device to the INTERFACE BOX as marked on the connections.

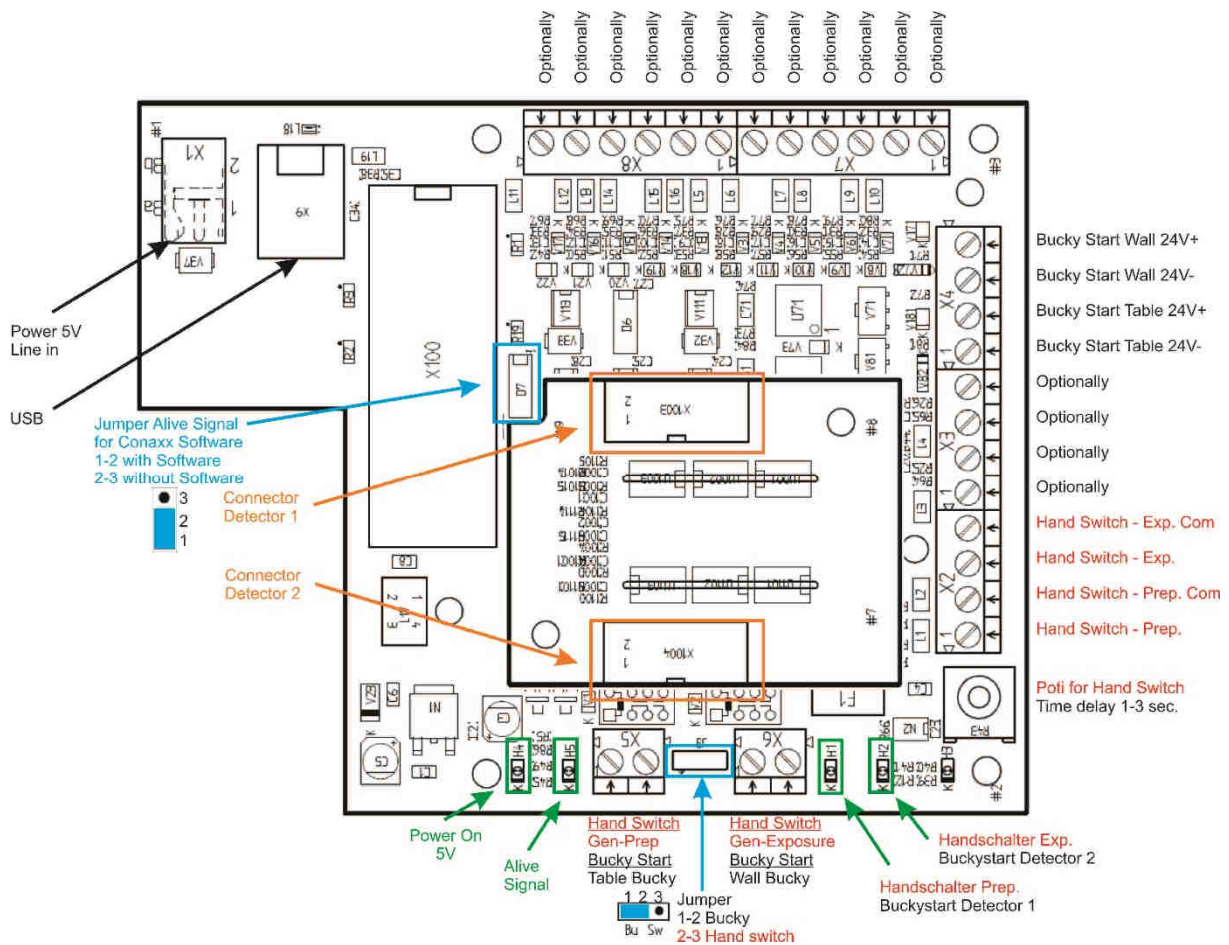

Procedure:

1. The power plug must not be plugged in.
2. Open the INTERFACE BOX by unscrewing the four screws.
3. Guide the cables from the hand switch to the X-ray device through the cable feedthrough.
4. Connect the cables from the hand switch and the X-ray system to the screw terminal as described.
5. Afterwards use the screws to close the INTERFACE BOX again.

3.5 Connection of the components

Connect the components as described in the following schematic diagram.

3.5.1 Operation with automatic exposure detection (AED)

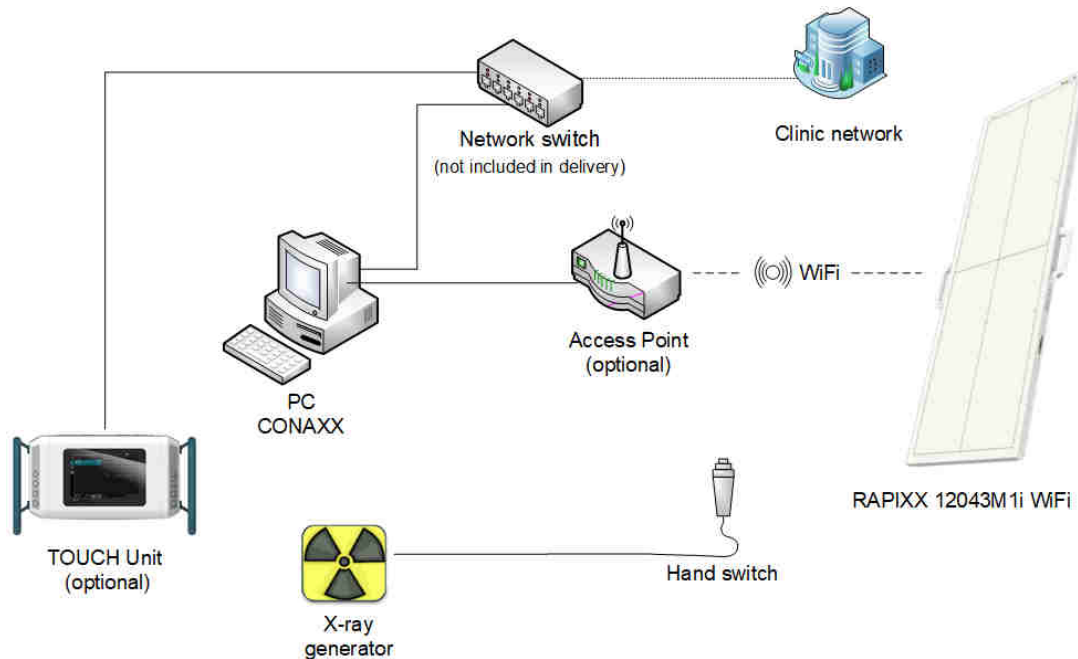

3.5.2 Operation with INTERFACE BOX

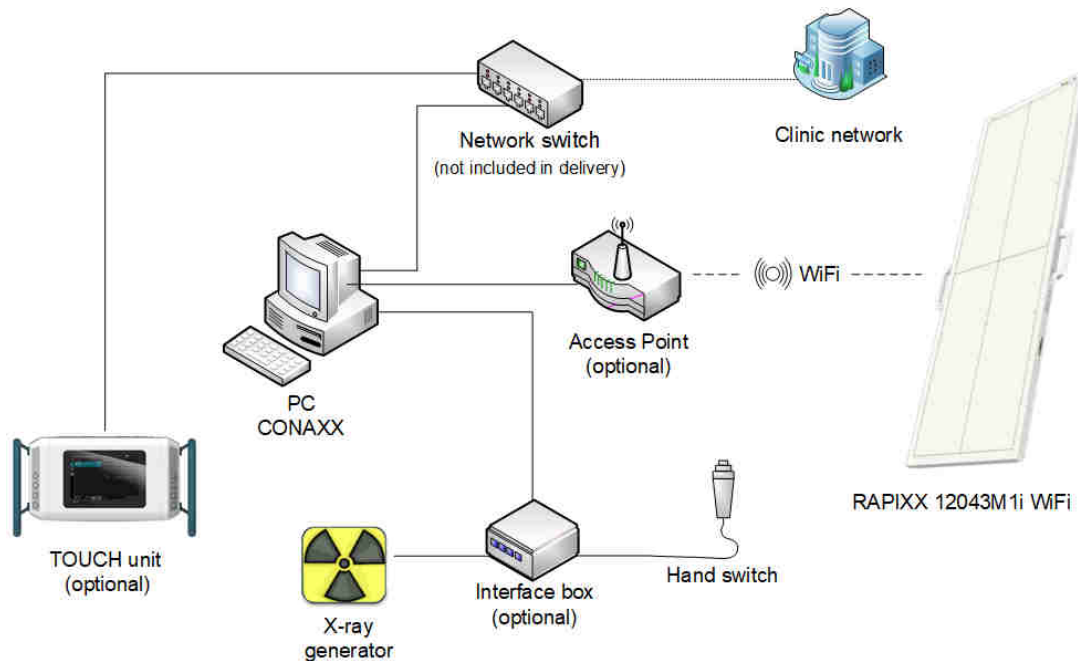

3.6 WLAN connection establishment with the detector

If the WLAN adapter built into the computer is used for a direct connection to the panel and not an Access Point, the WLAN connection must be established once to the detector.

Open the list with the available wireless networks. The detector WLAN is designated with the detector serial number, e.g., "SV360010H116240005X ". The password to use the detector WLAN is "12345678".



3.7 First start of CONAXX 2

Start CONAXX 2 with a double click on the desktop icon. Check the document "CONAXX 2 User Manual" for more details.

3.7.1 Necessary settings in CONAXX 2

After the first start of CONAXX 2 open the configuration by clicking the button "Configuration" in the start menu of CONAXX 2 and change into the section "System > Modality".

Select in the area "Selected Modality" the detector that you would like to use, e.g., "RAPIXX 12043M1i".

Depending on how the detector is built-in it might be necessary to rotate the acquired images in CONAXX 2. This can be changed in "Rotations" settings.

In case of using "AUTOMATIC EXPOSURE DETECTION" (AED) activate the according option.

When using a fixed anti-scatter grid with 40L/cm, the "GRID CORRECTION" option can be activated.



NOTE

The acquisition time window of the detector is 1000 milliseconds at delivery. If a longer acquisition time window is required for the X-ray images, please contact PROTEC's support.

Afterwards restart CONAXX 2.

3.7.2 Licensing of CONAXX 2

After the restart of CONAXX 2 you will be informed that the license does not fit to your system.

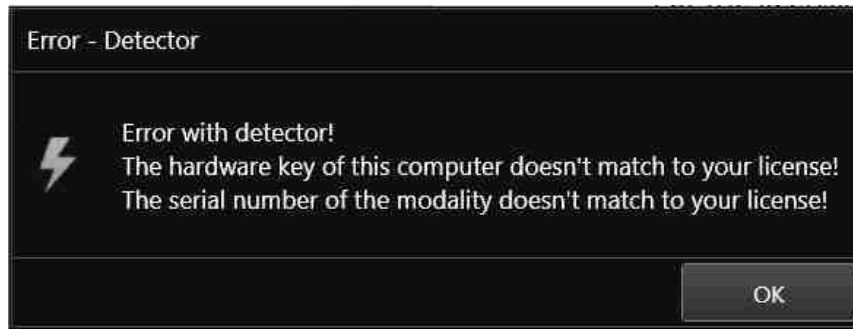

Confirm this message.



NOTE

For the licensing procedure it is necessary that CONAXX 2 can communicate with the connected detector. Please do not change the system configuration (network card, connected detectors, ...) otherwise the license may become invalid. In case of using more than one detector please connect all detectors to the computer.

Open the configuration of CONAXX and navigate to the "SYSTEM > REGISTRATION" section to create the license request. In the section "GENERATE HARDWARE KEY" select the function "SAVE KEY AS..." to create a license request. In the next step please choose the type of licensing.

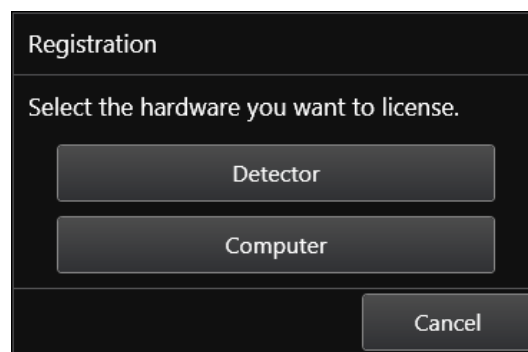

Two different types of licensing are supported:

Type of licensing	Properties
Detector-based	This type links the license with the detector.
Computer-based	This type links the license with the computer.

If no selection option appears, the detector only supports computer-based licensing.



NOTE

The module "Advanced image processing (AIP)" is generally linked to the computer. It is not possible to use it on other computers, even if the detector-based licensing is used.

There are two ways to send the hardware key:

1. Online with the licensing page of the dealer backroom or
2. by e-mail

For the online licensing, please login to the backroom and navigate to the page "LICENSING". Select the desired license and upload the hardware key with the function "SET". Download the license afterwards with "GET".

For the licensing by E-mail, send the hardware key to mis@protec-med.com. You will then get the valid license key by E-mail.

This license file must be imported in the section "SYSTEM > REGISTRATION" of the CONAXX 2 configuration.

Afterwards restart CONAXX 2. CONAXX 2 is now operational. The process with the DR-system is described in the document "CONAXX 2 User Manual".



NOTE

For detailed information on CONAXX 2 licensing please refer to the document "CONAXX 2 User Manual".

3.7.3 Activation of CONAXX 2 Modules

After licensing, make sure that the CONAXX 2 modules you purchased are activated.

For example:

- Advanced image processing (AIP)
- Grid suppression (optional)
- Diagnostic Viewer (optional)
- DICOM Worklist (optional)
- ...

For detailed descriptions of the modules, please refer to the CONAXX 2 User Manual.

3.8 Dose indicator settings for detector

For each detector the document "RAPIXX calibration values" is included. Follow the instructions in the document to setup the dose indicator

4 Calibration of the DR-System



NOTE

For the calibration make sure that the detector runs at least 2 hours.

General notes for calibration:

- Set the required SID of the detector manufacturer to 300 cm.
- Make sure that the detector is completely irradiated (no collimation).
- Ensure that there are no objects or dirt in the beam path.
- Use 70 kV for all calibration exposures.
- Calibrate with a horizontal beam path at right angles to the detector.
- Perform a gain and defect calibration every 6 months.

Start the program "RAPIXX Calibration" via the start menu in the folder "CONAXX2\DR-Panel". Make sure that the connection to the detector in CONAXX 2 has been successfully configured and established beforehand. Via "Start" the calibration can be started.

The gain calibration will be started with "Start" in the section "Gain" and each exposure must be prepared with the button "Prepare". Please follow the screen instructions and perform 5 exposures without any object. After the gain calibration, a status window will be shown.

The defect calibration will be started with "Start" in the section "Defect" and each exposure must be prepared with the button "Prepare". Please follow the screen instructions and perform 9 exposures without any object. After the defect calibration, a status window will be shown.

If GRID CORRECTION is used with a fixed 40L/cm anti-scatter grid, the anti-scatter grid must be calibrated into the image. Position the detector in the grid unit and make sure that the anti-scatter grid is inserted.

The grid calibration is started by clicking "Start" in the section "Grid" and the image must be prepared with the button "Prepare". Please follow the screen instructions and perform an exposure without any object. After the grid calibration, a status window will be shown.

The "RAPIXX Calibration" software can be closed.



NOTE

If problems occur during the calibration of the detector, please calibrate according to the supplied instructions of the detector manufacturer.

5 Control Elements and Displays

5.1 Control Elements and Displays of the Detector



	Description	Function
A	LED Power indicator	Displays the operating status of the detector
B	LED Link indicator	Displays the connection of the detector
C	LED Status indicator	Displays the status of the detector
D	LED Mode indicator	Displays the mode of the detector
E	Power button	Switching the detector on and off
F	Mode button	Changing the mode AP or Client

5.2 Display Detector Indicators

5.2.1 Display Power Supply (A)

LED	Description	Status
	Off	Detector switched off
	Green (steady)	DC input & battery power sufficient
	Green (flashing)	Powering ON/OFF in progress
	Orange (flashing)	Battery power insufficient ($\leq 15\%$)

5.2.2 Display Connection (B)

LED	Description	Status
	Off	a) Detector switched off b) Wired connection broken c) Wireless connection not ready
	Green (steady)	Wired connection built
	Blue (steady)	Wireless connection built
	Green (flashing)	Initializing

5.2.3 Display Status (C)

LED	Description	Status
	Off	a) Detector switched off b) Exposure prohibited
	Green (steady)	Exposure enabled
	Green (flashing)	a) Image is being transmitted b) Initializing
	Orange (steady)	Error occurred

5.2.4 Display Mode (D)

LED	Description	Status
	Off	a) Detector switched off b) Wired connection built
	Green (flashing)	Restoring the factory settings or switching the wireless mode
	Green (steady)	Wireless connection AP mode built
	Blue (steady)	Wireless connection Client mode built

For detailed information on the detector, please refer to the enclosed User Manual of the detector.

5.3 Displays Battery Charging Station

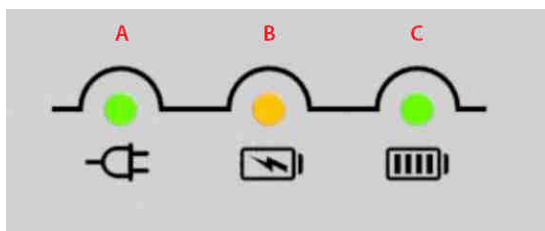

A	Display power supply
B	Display charging process
C	Display fully charged battery

LEDs	Description	Status
	All off	No power supply
	Display A on	a) power supply b) Batteries inserted
	Display A and B on	Battery is charging
	Display A and C on	Battery charged, charging process stopped
	Display A on B and C flashing alternately	Error occurred

For detailed information of the charging station, please refer to the enclosed User Manual of the detector.

5.4 Control Elements and Displays of the CONAXX 2 Acquisition Software

This area provides status information and tools for various components in the CONAXX 2 main window:



- **System:**

This function shows status information of the system.
This includes, for example, information about hard disk capacities.



- **Modality:**

This function opens the toolbox for the connected modality.
It provides functions to recover or close the connection to the modality or calibration functions. Furthermore, status information such as battery charge level is displayed.

Special detector status information:



- The detector is powered by an external power supply unit.



- The detector is powered by an external power supply unit and the battery is charging.



- The battery still has at least 75% of its charge.



- The battery still has at least 50% of its charge.



- The battery still has at least 25% of its charge.



- The battery still has at least 20% of its charge.



- The battery has less than 20% of its charge. No X-ray exposure is possible.



- The connection to the detector is interrupted. No X-ray exposure is possible.



- **X-ray generator:**

This function opens the x-ray generator control.
X-ray exposures can be made without taking images via the modality.

For detailed information of the CONAXX 2 acquisition software, please refer to the CONAXX 2 User Manual.

6 Handling

6.1 Requirements before and during Operation

It must be ensured that the surfaces in contact with patients are disinfected before the X-ray examination of each patient (see chapter 7.3.2).



WARNING!

In the event of a technically incorrect image acquisition (e.g., missing image content, strip structures), the entire X-ray system must be restarted and a test exposure must be taken without patient. Only if the exposure is correct, the system can be used again properly. If the test exposure is still defective, please contact PROTEC customer service or a service authorized by them.

6.2 Operation

6.2.1 Start-up order for daily use

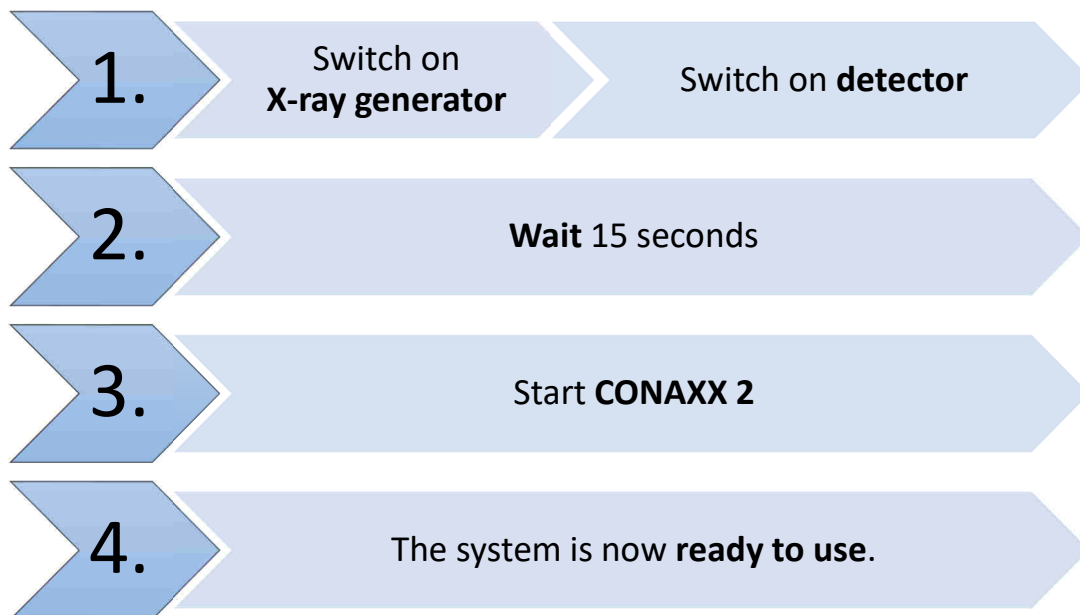

If CONAXX 2 cannot connect to the modality or generator after launching the program, there will appear an error message. In this case, CONAXX 2 must be restarted to initiate a new connection attempt.

More detailed information can be taken from the error message displayed by CONAXX 2.

If no error message appears after starting the program, the connection was established successfully and the system can be used.

6.2.2 Operation of the CONAXX 2 acquisition software

For detailed information of the CONAXX 2 acquisition software, please refer to the CONAXX 2 User Manual.



NOTE

In order to keep quality and battery power optimal for wireless detector systems, it is recommended to press the "Start exposure" button in the CONAXX 2 software only after all preparation for the exposure (e.g., patient positioning) have been made and the X-ray system is ready to be triggered.

6.2.3 Operation of the detector with accessories

For detailed information of the detector, please refer to the enclosed original instructions *UserManual_Venu1748V* of the detector manufacturer



WARNING!

If the detector of the DR-system is operated via data cable and with direct patient contact, it must be ensured that the data cable is equipped with a network isolator in accordance with EN 60601-1.

6.2.3.1 Battery handling and battery changing

For detailed information on handling the battery and charger, as well as on changing the battery, please refer to the enclosed original instructions *UserManual_Venu1748V* of the detector manufacturer.



NOTE

Before changing the battery, it is recommended to switch off the detector. After the battery change, the detector can be switched on again.



CAUTION!

Only 1 battery may be charged in the charging station at the same time. If more than 1 battery is inserted, the charging station is not working.

6.3 Function of the digital X-ray detector system

6.3.1 Switching on the RAPIXX DR system

The digital X-ray detector system is first switched on by switching on the detector. This is done either by pressing the on/off button on the detector with inserted battery or by inserting the battery into the compartment provided on the back the detector, which then switches on automatically. After waiting 15 seconds, the CONAXX 2 acquisition software can be started by double-clicking on the desktop icon. If no error message appears while starting the program, the connection has been established correctly and the system can be used. If no connection can be established, proceed as described in the section "Troubleshooting while connection establishment".



NOTE

During usage of the PROTEC detector charging function, the detector is automatically switched on if it is placed in the drawer and the X-ray system is switched on.

6.3.2 Switching off the RAPIXX DR system

To shut down the system, the following components must be switched off one after the other:

1. Detector

The detector can be switched off in two ways:

- a. via the on/off button on the detector
- b. via the "switch off" function in the "Modality" status area of the CONAXX 2 software.

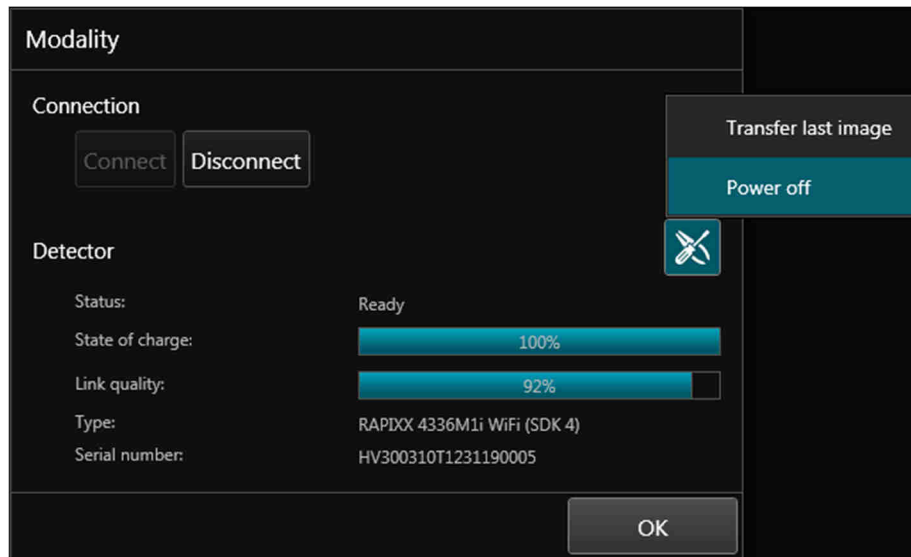

2. CONAXX 2 software

The software can be shut down via the "Exit" menu item in the main menu.

6.3.3 Switch-on order for battery changing

1. Switch off the detector
2. Change the battery
3. As soon as the new battery charge level is displayed in the status window, the window can be closed and work can be continued.

If no error message appears during the automatic connection, the connection has been established correctly and the system can be used.

If no connection can be established, proceed as described in the section "Troubleshooting while connection establishment".

6.3.4 Troubleshooting while connection establishment

If the connection cannot be established, it can be established manually in the toolbox in CONAXX 2.

1. Open „Toolbox“ ()
2. Press the „Disconnect“ button
3. Make sure that the detector is switched on
4. Press „Connect“ button

If no error message appears, the connection has been established correctly and the system can be used.



NOTE

If problems with the WLAN connection occur permanently, please note the following information:

Is there an obstacle in the WLAN transmission path that weakens the signal?

Is there an interfering transmitter near the WLAN connection (smartphone, DECT phone, baby monitor, wireless speaker, etc.)?

Is the WLAN switched on at the detector?

6.3.5 X-ray generator errors during operation

If an error occurs with the X-ray generator during daily operation, the error message provides information on how to solve the problem.

If the connection to the X-ray generator is interrupted during operation with CONAXX 2, it must be restarted. A new connection attempt is not initiated until the restart. If no error message appears during the restart, the connection was established correctly and the generator can be used.

6.3.6 Modality errors during operation

If an error occurs with the modality during daily operation (e.g., communication error, power blackout), the error message provides information on how to solve the problem.

If the connection to the modality is interrupted during the runtime of CONAXX 2, CONAXX 2 must be restarted. A new connection attempt is not initiated until the restart. If no error message appears after the restart, the connection has been established successfully and the modality can be used.

6.3.7 Positioning the organ when using automatic exposure detection (AED)



WARNING!

To ensure the function of the automatic exposure detection (AED), the following factors must be observed for each X-ray exposure:

- The X-ray radiation or insertion must encounter and at least partially cover the area marked in green in the image.
- The area marked in green must not be completely covered with highly absorbent metal/material, e.g., by a prosthesis, gonadal protection, lead gown, etc.
- If the marked area in green is completely covered with a body organ, it must be ensured that the correct dose is applied for the organ. Underexposure may result that the AED sensor is not triggered.

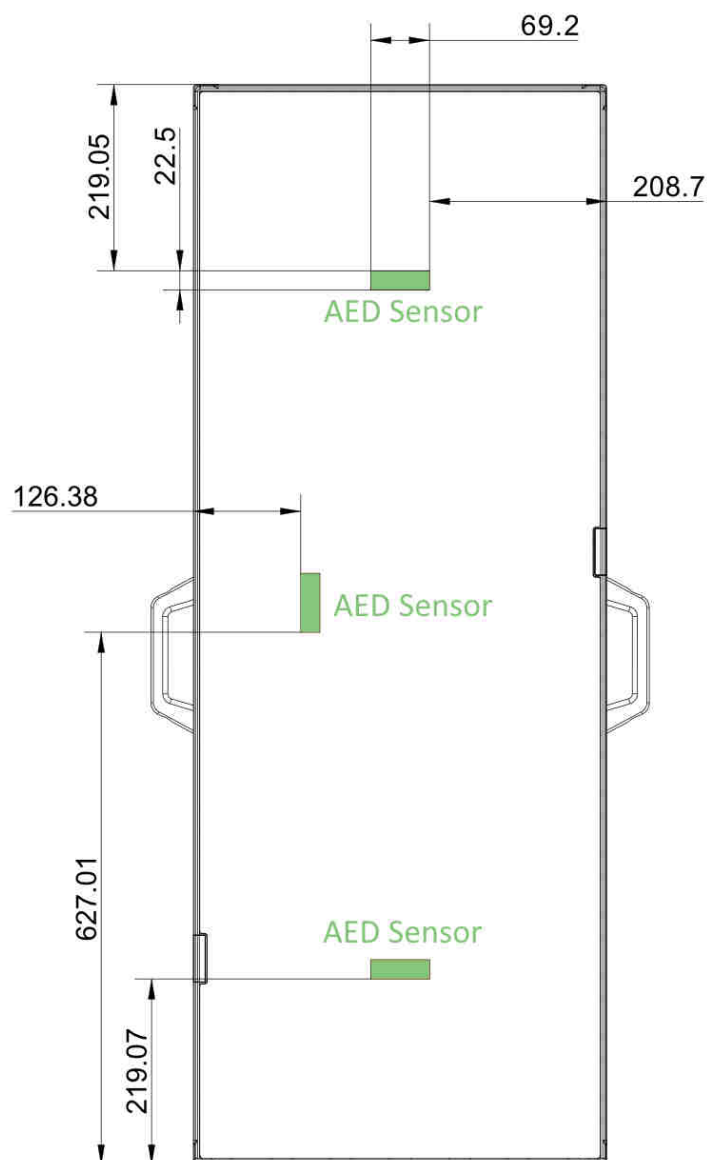

7 Safety and Maintenance



WARNING!

Caution, risk of electric shock!

Switch off the RAPIXX DR-system before cleaning or disinfecting. This disconnects the digital X-ray detector system from the power source and avoids the risk of electric shock.

7.1 Introduction

In this chapter you will find information about safety and maintenance that are necessary to ensure the correct and reliable function of the device after installation.

7.2 Reusability

The RAPIXX DR-system can be reused without any special preparation procedures.

However, it must be ensured that the surfaces in contact with patients are disinfected before the X-ray examination of each patient (see also chapter 6.1).

The RAPIXX DR-system must no longer be used with patients if it shows signs of wear (e.g., metal abrasion, wear of insulations) or dangerous technical defects (e.g., missing, defective or bent parts) or if the resulting image quality (e.g., artifacts in the image) is insufficient.

In this case, please contact PROTEC service department or a service company authorized by them immediately.

7.3 Cleaning and Disinfection



WARNING!

Make sure that no liquid enters the interior of the housing during cleaning and disinfection in order to prevent electrical short circuits and/or corrosion.



CAUTION!

Possible material changes!

Do not use any corrosive, solvent or abrasive cleaning agents that may damage the surface of the device or the coating.

Do not use an excessive amount of ethanol (or neutral cleaner), to prevent liquids from the surface from entering the inside of the detector or its accessories. This will prevent damage and peeling of labels on the detector or its accessories.

Do not use a solvent such as thinners or benzine, as it reacts with the surface of the detector.

Never immerse or flood any parts during cleaning.

7.3.1 Cleaning

The cleaning of the digital X-ray system is very easy due to the very good quality surface coating. This is usually only done with a soft dry cloth.

Do not use corrosive, dissolving or abrasive cleaning agents, which could damage the device surfaces or the coating.

To clean the detector and its accessories, we recommend using cleaning agents that evaporate quickly and therefore prevent liquids from entering inside of the housing.

Commercially available medical rapid disinfection wipes (e.g., Dr. Schumacher Descosept Sensitive Wipes) can be used.

If ready-to-use cloths are not used, cloths lightly soaked with neutral cleaner can be used. These must be carefully wrung out that no liquids from the surface can enter the interior of the detector or its accessories.

Detailed instructions can be found in the enclosed original instructions for the system components.

7.3.2 Disinfection

The disinfection must be performed in accordance with the current applicable legal requirements and guidelines corresponding for disinfection and explosion protection.

For disinfection of surfaces in contact with patients, we recommend commercially available medical rapid disinfection wipes (e.g., Dr. Schumacher Descosept Sensitive Wipes).



WARNING!

No highly flammable disinfectants may be used! For safety reasons, spray disinfection must not be carried out, as the spray mist could penetrate the device and cause short circuits or corrosion.

If disinfectants are used that can form explosive gas mixtures, the device may only be switched on again when the gas mixtures have evaporated!

Detailed instructions can be found in the enclosed original instructions for the system components.

7.4 Inspection and Maintenance



WARNING!

No maintenance or repair work may be performed while the digital X-ray detector system is being used with a patient!

All maintenance and repair work may only be performed by personnel trained or authorized by PROTEC.

7.4.1 Daily Monitoring before and during the Examination Operation

The detector surface must be daily checked before operating start if there are any visible damages. In case of visible damages, a technical homogeneity X-ray (without any patient) should be taken to check if they are visible inside the image.

For detailed instructions, refer to the enclosed original manuals for the system components.

7.4.2 Regular Monitoring

In the interest of the safety of the patient, operator and external third parties, checks that maintain the operational safety and functionality of the device are required to be undertaken in regular 12 months intervals by the PROTEC service department or a PROTEC authorized service technician. This includes the control of the image quality as well.

It is recommended to calibrate the digital X-ray detector system every 6 months at least.

Detailed instructions can be found in the enclosed original manuals of the system components.

7.4.3 Maintenance

The required maintenance must be carried out by PROTEC service department or a service company authorized by them in order to ensure the safe and reliable functionality of the device. The maintenance intervals depend on the frequency of use. Prior to the examination operation, the user must satisfy himself that all appliances listed in the operating instructions and serving safety are in working order and that the RAPIXX DR-system is ready for operation.

Detailed instructions can be found in the enclosed original manuals of the system components.



WARNING

Wear parts must be replaced with original parts.



NOTE

In the case that the required maintenance is not completed as intended, PROTEC X-ray Systems GmbH is no longer responsible for injuries to the operator and third parties, provided that the damage is the result of improper or missing maintenance.

7.4.4 Warranty



NOTE

The current warranty conditions can be found in your order documents.

Repairs and spare parts in the event of improper use are also excluded.
Warranty work may only be carried out by trained specialists.

7.4.5 Product Service Life

Detailed information on the product service life can be found in the enclosed original instructions for the system components. After the product has reached the end of its service life, further use is at your own risk.

7.4.6 Further Information

Detailed information and further descriptions for "Safety and Maintenance" of the detector can be found in the enclosed original manual of the detector manufacturer *User Manual_Venu1748V*.

7.4.7 Applied Parts and Parts Considered as Applied Parts

Part	Definition (Applied part or part that is treated like an applied part but is not defined as an applied part)
Detector	Applied part type B

7.4.8 Disposal Notes



The digital X-ray detector system contains various plastics, chemical elements and heavy metal. When disposing exchange and spare parts, or if necessary, the entire device, the valid rules and regulations must be observed. Please contact your contractual partner or service company or commission a company specialized in disposing the respective components.

8 Power Supply



WARNING!

To avoid the risk of an electric shock, this device may only be connected to a supply network with a protective earth conductor.

8.1 Electromagnetic Compatibility (EMC) according to EN 60601-1-2



CAUTION!

As a medical electrical device, the components of the RAPIXX DR-system are subject to special precautionary measures regarding EMC and must be installed and commissioned in accordance with the EMC information contained in the accompanying documents.



CAUTION!

Portable RF communication devices (radio devices) should not be used closer than 30 cm (12 in) to the marked parts and cables of the digital X-ray detector system. Failure to observe can lead to a reduction in the performance characteristics of the device.

For information on the electromagnetic compatibility of the detector and its accessories, refer to the enclosed original instructions of the detector manufacturer *UserManual_Venu1748V*.

9 Technical Data

9.1 Dimensions Detector

Dimension (L x W x H): 1271.4 mm x 586.6 mm x 20.8 mm

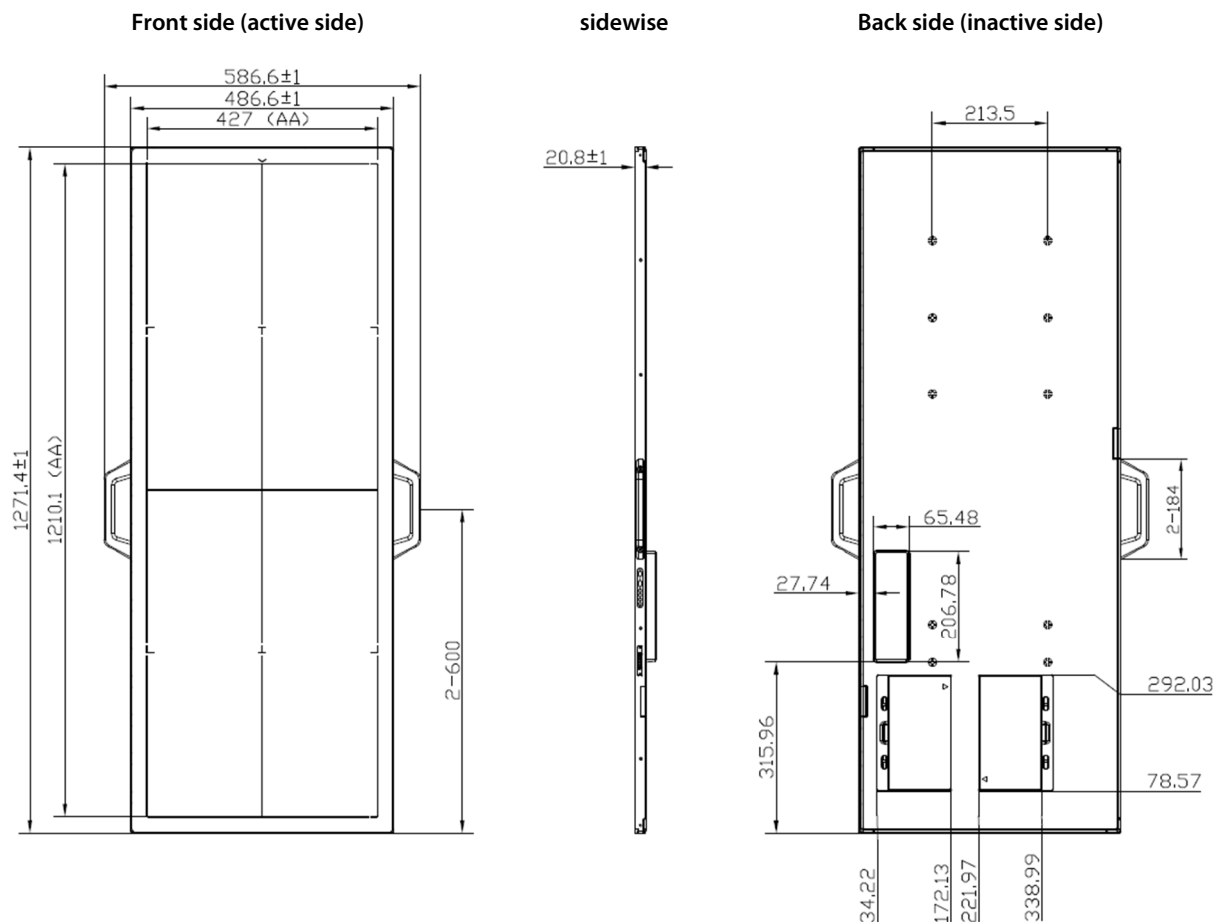

9.2 Technical Data Detector

Resolution	139 µm
Scintillator	CsI
X-ray energy	40 kV – 150 kV
SID	0 cm – 350 cm
Active area	1208.7 mm x 425.8 mm
Effektive pixel matrix	3064 x 8696
Uniform load	max. 30 kg
Punctual load	max. 30 kg on an area with 4 cm diameter
Weight	18 kg incl. two batteries

For information of the detector and its accessories, refer to the enclosed original instructions of the detector manufacturer *UserManual_Venu1748V*.

9.3 Protection Type and Protection Class

For detailed instructions on the protection type and protection class, refer to the enclosed original instructions for the system components.

9.4 Automatic Cut-off dose

The recommended automatic cut-off dose on the X-ray system with the digital X-ray detector system is 2.7 μGy .

9.5 Environmental Conditions

9.5.1 Environmental Conditions during Operation













Ambient temperature	+5°C to +35°C
Relative humidity	10% to 90%
Atmospheric pressure	700 hPa to 1060 hPa











9.5.2 Environmental Conditions for Shipping and Storage

Ambient Temperature	-20°C to +55°C
Relative humidity	5% to 95%
Atmospheric pressure	700 hPa to 1060 hPa

10 Description of Symbols, Labels and Abbreviations

10.1 Symbols

	Atmospheric pressure limit
	Temperature limit
	Humidity limit
	Keep dry
	Protect from sunlight
	Fragile, handle with care
	Handle with care
	Punctual load (Ø 4cm)
IPxx	Protection type
	This way up
	Attention, observe accompanying documents
	Refer to Instructions for use
CE	CE-certification, with number of notified body if applicable
	Manufacturer
MD	Medical Device

	Order reference
	Serial number
	Unique Device Identification
	Production date
	Classification according to EN 60601-1 (type B applied part)
 www.protec-med.com/download	This symbol indicates the need to observe the instructions for use. This is provided in an electronic format (eIFU) on our website.
	Disposal instructions; WEEE (Waste of Electrical and Electronic Equipment)
	Protective earthing
	System (CONAXX 2)
	Modality (CONAXX 2)
	X-ray generator (CONAXX 2)

10.2 Type Labels

10.2.1 RAPIXX DR-System

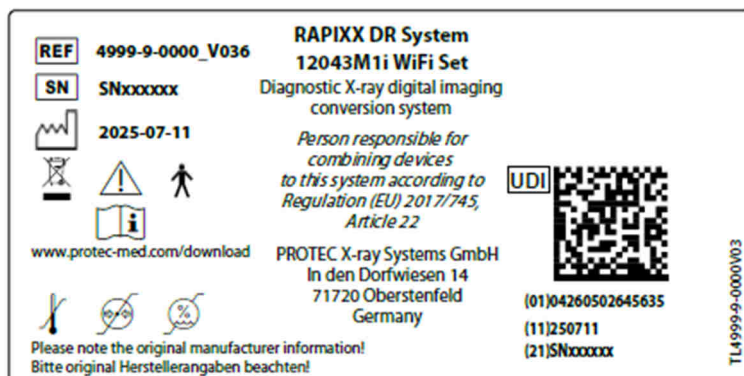

REF 4999-9-0000_V036

SN SNxxxxxx

2025-07-11

www.protec-med.com/download

RAPIXX DR System
12043M1i WiFi Set
Diagnostic X-ray digital imaging conversion system

Person responsible for combining devices to this system according to Regulation (EU) 2017/745, Article 22

PROTEC X-ray Systems GmbH
In den Dorfwiesen 14
71720 Oberstenfeld
Germany

UDI (01)04260502645635
(11)250711
(21)SNxxxxxx

TL4999-9-0000V03

Please note the original manufacturer information!
Bitte original Herstellerangaben beachten!

Example Type Label RAPIXX DR-System

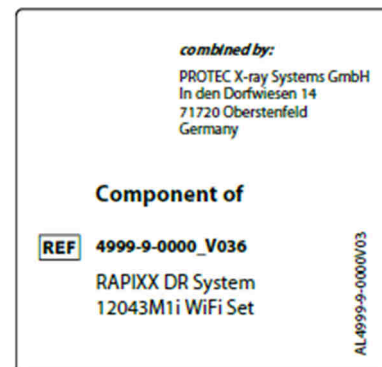

combined by:
PROTEC X-ray Systems GmbH
In den Dorfwiesen 14
71720 Oberstenfeld
Germany

Component of

REF 4999-9-0000_V036

RAPIXX DR System
12043M1i WiFi Set

AL4999-9-0000V03

Example component RAPIXX DR-System

10.2.2 Detector



数字平板探测器

产品型号: Venu1748V
 配置: Venu1748V-WF
 接入电源: 适配器供电输入 24V \equiv 1.5A
 电池1/2供电输入 10.8V \equiv 1.6A



上海奕瑞光电科技股份有限公司
 上海市浦东新区
 瑞庆路590号9幢2层202室

使用期限: 7年, 其他内容详见说明书



20XX-XX-XX





Digital Flat Panel Detector

Model: Venu1748V
 Configuration: Venu1748V-WF
 Power: Adapter Port Input 24V \equiv 1.5A
 Battery1/2 Port Input 10.8V \equiv 1.6A





iRay Technology Co., Ltd.
 RM202, Building 7, No. 590, Ruiqing RD.,
 Zhangjiang East, Pudong, 201201 Shanghai P. R. China
 www.iraygroup.com
 20XX-XX-XX

EC REP iRay Europe GmbH
 In den Dorfwiesen 14, 71720 Oberstenfeld
 Germany

SN 

UDI 

(01)XXXXXXXXXXXXXXXXXX(11)XXXXXXXX(17)XXXXXXXX(21)XXXXXXXXXXXXXXXXXX

MD Rx only

CE 0344

Example type label iRay Venu 1748V detector

10.2.3 Battery charging station (charger) and detector battery



充电器

产品型号: CHARGER-COMBO
 接入电源: 输入 100-240V~50/60Hz
 1.0A MAX.
 输出1 12.6V \equiv 2.5A
 或 输出2 13.2V \equiv 2.5A
 或 输出3 8.7V \equiv 2.5A



奕瑞影像科技(太仓)有限公司
 中国江苏省
 太仓港经济技术开发区兴港路33号

其他内容详见说明书 Made in China



20XX-XX

CE 0197

IP 20

IS 13252(PART 1) 2010/
 IEC 60950-1:2005

R-41231690
 www.bis.gov.in

Charger

Model: CHARGER-COMBO
 Power: Input 100-240V~50/60Hz
 1.0A MAX.
 Output1 12.6V \equiv 2.5A
 OR Output2 13.2V \equiv 2.5A
 OR Output3 8.7V \equiv 2.5A

iRay Technology Taicang Ltd.
 No.33 Xinggang Road, Taicang Port Economic and
 Technological Development Zone, Jiangsu, China
 www.iraygroup.com

EC REP iRay Europe GmbH
 In den Dorfwiesen 14, 71720 Oberstenfeld Germany

SN 

Example type label iRay battery charging station

可充电锂离子电池组

产品型号: BATTERY4V
 额定电压: 10.8V
 充电限制电压: 12.6V
 额定容量: 4180mAh/4.55Wh
 典型容量: 4180mAh/4.54Wh
 执行标准: GB31241-2014
 识别码: 3EPV/05/90

上海奕瑞光电科技股份有限公司
 上海市浦东新区
 瑞庆路590号9幢2层202室 201201

CE **5**

iRay Technology Co., Ltd.
 Rm. 202, Building 7, No. 590, Ruiqing Rd.,
 Zhangjiang East, Pudong, Shanghai, China 201201
 www.iraygroup.com

EC REP iRay Europe GmbH
 In den Dorfwiesen 14, 71720 Oberstenfeld Germany

CAUTION:

- Prohibited to disassemble, hit, separate or throw into the fire.
- Please charge the battery **upside** to avoid our discharge failure.
- If severe ballooning, please do not continue to use. **IS 16046(Part 2) IEC 62133-2**
- Please do not put battery in high temperature environment.
- Please use the charger designated by Ray to charge the battery.
- Please do not use chargers of any other specifications.
- Please charge the battery **full** before first use.
- Please charge the battery immediately when the capacity is less than 5%.
- Replace battery with the same model or. Use other model batteries may present a risk of fire or explosion.
- Keep away from children.
- Dispose of used batteries according to **RoHS**.

Avertissement:

- Ne pas débrancher, réparer, comprimer le batterie ou mettre au feu.
- Le surcharge, ve élarger les performances de la batterie.
- Un cas de gonflement, ne plus utiliser le batterie, ne pas laisser le batterie dans un environnement à haute température.
- Utiliser le charger spécifié par Ray pour charger le batterie.
- N'utilisez pas d'autres modèles de chargeurs.
- Chargez le batterie pleinement lors de la première utilisation.
- Chargez le batterie immédiatement lorsque le batterie est moins de 5%.
- Remplacez le batterie avec le même modèle, sinon le batterie peut exploser ou brûler.
- Mettez le batterie hors de la portée de enfants.
- Éliminez les batterie des piles usagées conformément aux lois locales.









Li-ion

SN 

Example type label iRay battery

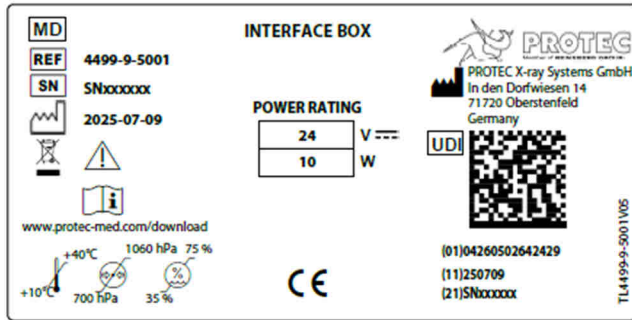
10.2.4 INTERFACE BOX



Example type label INTERFACE BOX

10.2.5 CONAXX 2

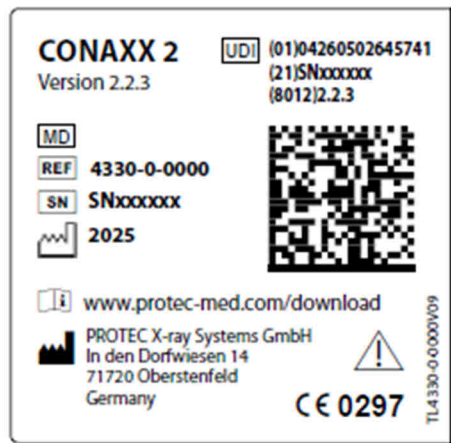

Example type label CONAXX 2

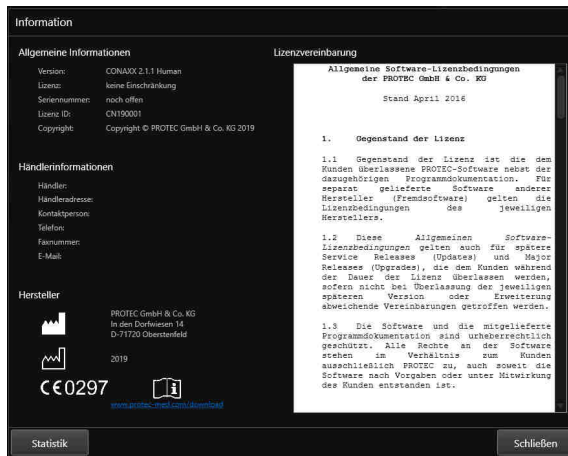

Example specification in the CONAXX 2 interface

10.3 Labels

10.3.1 Detector

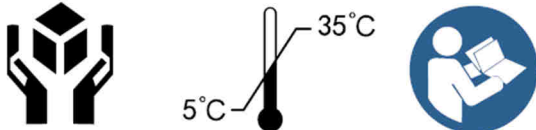

Label imprint on surface iRay Venu1748V detector

10.4 Positions of the Signs and Labels

10.4.1 Detector

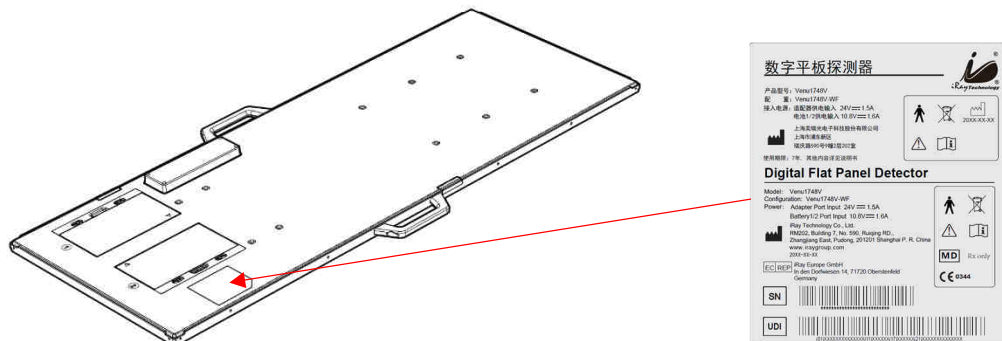

The type labels are located on the underside of the detector.

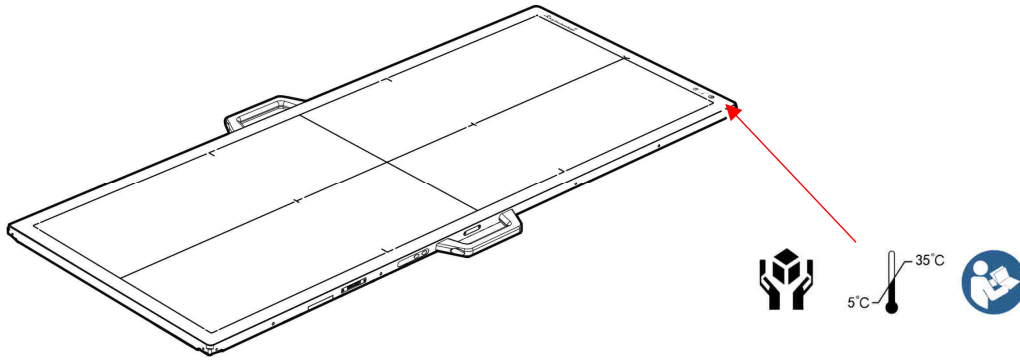

Der Hinweise-Aufdruck befindet sich auf der Oberfläche des Detektors.

10.4.2 Battery charging station

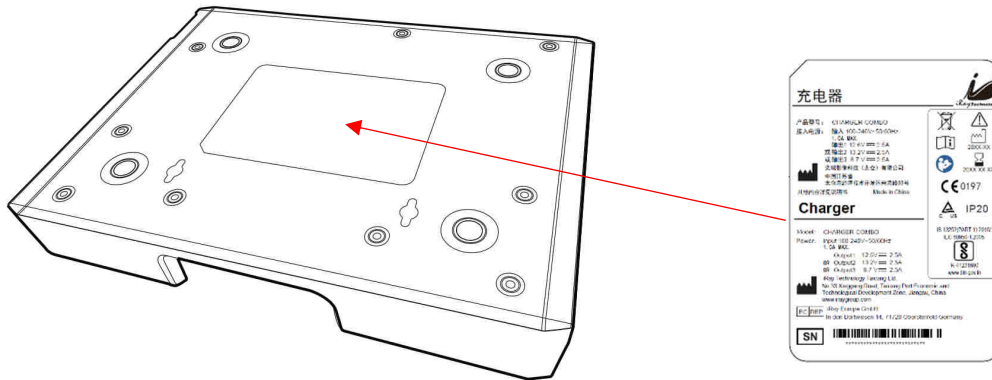

The type label is located on the underside of the battery charging station.

10.4.3 Battery

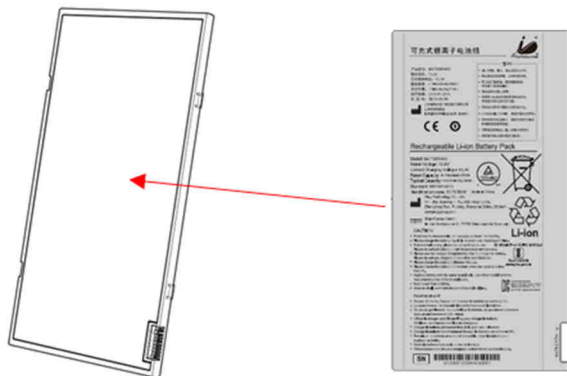

The type label is printed on the bottom of the battery.

10.4.4 INTERFACE BOX



The type labels are located on the underside of the INTERFACE BOX.

10.5 Abbreviations

mm	Millimeter
cm	Centimeter
m	Meter
µm	Micrometer
µGy	Microgray
kg	Kilogram
°C	Degree - Celsius
hPa	Hectopascal
DIN	German Industry Standard
EN	European Standard
CE	CE-Mark
Hz	Hertz
A	Ampere
SN	Serial number
EMC	Electromagnetic compatibility
HF	High frequency
LP/mm	Line pairs per millimeter
CsI	Cesium iodide
IP	International Protection