

PRS 300 VET TOUCH

Veterinary X-ray System

Model/ID: 7018-9-2000_Vxxx

Instructions for use

Ident. Nr. 5018-0-0002





HINWEIS

This document contains proprietary and confidential information of PROTEC X-ray Systems GmbH and is intended for exclusive use by current PROTEC X-ray Systems GmbH customers. Copying, disclosure to others or other use is prohibited without the express written authorization of PROTEC X-ray Systems GmbH law department. Report any violations of this to PROTEC X-ray Systems GmbH.

© 2025 PROTEC X-ray Systems GmbH, Oberstenfeld

Send inquiries regarding this document to the following address:

PROTEC X-ray Systems GmbH

In den Dorfwiesen 14 | 71720 Oberstenfeld
Deutschland

Tel: (+ 49) 7062 – 92 55 0

Fax: (+ 49) 7062 – 92 55 60

E-Mail: PROTEC@PROTEC-med.com

Internet: www.PROTEC-med.com

Table of content

	Seite
Table of content	3
Document effectivity	5
General Warnings.....	6
Mechanical and electrical warnings.....	6
Radiation warning.....	6
To the user.....	6
Improvement Recommendations	7
1 Product Description	8
1.1 Introduction	8
1.2 Description.....	8
1.2.1 Product Components.....	8
1.2.2 Installation	8
1.2.2.1 Floor loadability.....	9
1.3 Special Features.....	9
1.3.1 Patient table	9
1.4 Purpose	9
1.5 Circle of user	9
2 Safety warnings	10
2.1 General Safety notes.....	11
2.1.1 Operating requirements.....	11
2.1.2 Operation.....	11
2.1.2.1 Operating Mode	11
2.1.3 Operating personal.....	11
2.1.4 Crushing and collision danger.....	12
2.1.5 Explosion PROTEction.....	12
2.1.6 Radiation PROTEction	12
2.1.7 Ventilation.....	12
2.1.8 Interaction with other devices.....	12
2.1.9 Electromagnetic environment and Influence of other devices	13
3 Operating Elements and Displays	14
3.1 PRS 300 VET TOUCH.....	14
3.1.1 Operating Elements and Displays of the mobile X-ray System.....	14
3.1.2 Operating elements of the screen holder Ergotron LX.....	14
3.1.3 Operating Elements and Displays of the CONAXX 2 Vet Software	14
3.1.4 Operating elements and displays of the RAPIXX system	14
3.1.5 Operating elements and displays of the touchscreen.....	14
4 Handling	15
4.1 Operation.....	15
4.1.1 Operation of the mobile X-ray System	16
4.1.2 Operation of the screen holder Ergotron LX.....	16
4.1.3 Operation of the CONAXX 2 VET software	16
4.1.4 Operation of the RAPIXX system	16
4.1.5 Operation of the Touchscreen.....	16
4.2 Function of the PRS 300 VET TOUCH.....	16
4.2.1 Off- and On-turning of the PRS 300 VET TOUCH.....	16
4.3 Remove the mobile X-ray generator to use it elsewhere.....	17
5 Safety and maintenance	19
5.1 Introduction	19
5.2 Cleaning and disinfection.....	19
5.2.1 Cleaning.....	19
5.2.2 Disinfection	19
5.3 Reviewing and maintenance.....	20

5.3.1	Daily control before and while working.....	20
5.3.2	Regular Checks.....	20
5.3.3	Maintenance	20
5.3.4	Warranty.....	20
5.3.5	Product lifespan	20
5.3.6	Further information.....	20
5.3.7	Disposal instructions	20
6	Power Supply	21
6.1	Operating conditions	21
6.1.1	Mobile Generator ORANGE 1060 HF	21
6.1.2	RAPIXX System	21
6.2	Electromagnetic Compatibility (EMC) after EN 60601-1-2	21
7	Technical Data.....	22
7.1	Dimensions.....	22
7.2	Attenuation equivalent.....	23
7.2.1	PROTEction class	23
7.3	Automatic cutoff dose.....	23
7.3.1	Digital System.....	23
7.4	Environmental conditions.....	23
7.4.1	Environmental conditions for operation	23
7.4.2	Environmental conditions for transport and storage	23
8	Descriptions of Image Signs, labels and Abbreviations.....	24
8.1	Image Signs.....	24
8.2	Type signs.....	24
8.3	Positions of the signs and labels	26
8.4	Abbreviation	27

**INFORMATION**

The information this document is containing conforms to the configuration of the equipment as of the date manufacture. Revisions to the equipment subsequent to the date of manufacture will be addressed in service updates distributed to the PROTEC X-ray Systems GmbH Technical Service Organization.

Document effectivity

Revision No.	Date	List of effective pages	Comment
1.0	23/01/2017	all	Original issues
2.0	2025-07-18	All	First edition PROTEC X-ray Systems GmbH

General Warnings

**WARNING!**

It's forbidden to make any changes on the ME-device!

Mechanical and electrical warnings

**WARNING!**

Any moveable parts should be operated with care and routinely inspected in accordance with the manufacturer's recommendations contained in the documents.

Maintenance and Service can only be done by people who got authorized by PROTEC X-ray Systems GmbH. Touching electrical parts and connections can be deadly!

Do not remove flexible high-tension cables from the X-ray tube housing or high-tension generator and/or access covers from X-ray generator.

All parts have to be earthed according to the countries laws.

Not considering the previous aspects may result in serious or fatal injuries to the operator or others in the area.

Radiation warning

**WARNING!**

All products described in this document are parts of a system for the generation of X-rays for veterinary diagnosis.

X-rays generate a potential risk for both patients and operators.

For this reason the application of X-rays for a given medical purpose must aim at the minimization of radiation exposition to any person.

Those persons responsible for the application must have the specific knowledge according to legal requirements and regulations and must establish safe exposure procedure for these kind of systems. The responsible persons for planning and installation of this equipment must observe the national regulations.

To the user

**INFORMATION**

The user of this document is directed to read and carefully review the instructions, warnings and cautions contained herein prior to beginning operation, installation or service activities. While you may have previously operated equipment similar to that described in this document, changes in design, manufacture or procedure may have occurred which significantly affect the present operation. Even if this product was brought to its limits, there is always a risk within usage left. Those will be explained in the following limits and warnings. Installations and service of the device described in this document can only be performed of people authorized by PROTEC X-ray Systems GmbH. Any other person is obligated to contact the local PROTEC X-ray Systems GmbH office before attempting installations or service procedures.

Before attempting any installation or service procedures it's necessary to read the „Technical description“ of this device and to consider any containing aspect.

**INFORMATION**

The usage of this device in correlation with unauthorized third party parts is not allowed.

Improvement Recommendations

Users of this document are encouraged to report errors, omissions and improvement recommendations to PROTEC X-ray Systems GmbH.

1 Product Description

1.1 Introduction

This manual describes the special features and aspects that are necessary for an effective usage of the X-Ray system PRS300 VET TOUCH.

Before starting to work with the PRS VET TOUCH, it is recommended to read the safety notes and the operating chapter.

1.2 Description

1.2.1 Product Components

The PROTEC X-ray system PRS 300 VET TOUCH has following components:

- A stationary, fix X-ray table with integrated column including the commanding arm,
- A Grid Entity/Bucky*,
- A CONAXX PC/Notebook
- A mobile X-ray generator (e.g. ORANGE 1060HF),
- A Tube*
- a direct X-ray system (consisting of a DR-Detector* (e.g. RAPIXX-set) and software)

optional components

- Anti-scatter grid*,
- Ionisation measuring chamber* and
- a Dose area product meter*

* These components can also be used within patient area.

Equipment that could influence the EMV-conditions

- Network cable (note the max. length in the manuals)
- RAPIXX data-cable (note the max. length in the manuals)
- WLAN-Router (use only devices that are licensed by PROTEC)

1.2.2 Installation

See separate Installation manual PRS 300 VET TOUCH

Any contact information of people that are qualified to make installations are available via inquiry at:

PROTEC X-ray Systems GmbH

In den Dorfwiesen 14 | 71720 Oberstenfeld

Telefon:+49 (0) 7062 – 92 55 0

Fax: +49 (0) 7062 – 92 55 60

E-Mail: PROTEC@PROTEC-med.com

Internet: www.PROTEC-med.com

1.2.2.1 Floor loadability



NOTE

The X-ray system consists primary of metal parts. This has direct effect onto the weight of the device.

The X-ray system PRS 300 VET TOUCH has a weight of **206kg (not including Generator).**

Any engineer is obliged to test the loadability of the floor before doing any installations. Also it is important to take doublefloors / hollow floors into account.

1.3 Special Features

1.3.1 Patient table

- Floating tabletop
- White coloured tabletop
- Manual tabletop break for easy patient movements
- High adjustment range for patient positioning.
- High reliability.
- Prepared for the installation of a Bucky with grid and a 3-area-measuring chambers for the useage with an automated exposures.
- Extensive cassette-sets, from 13cm x 18cm up to 35,6cm x 43cm
- Ceiling free column tripod suitable for rooms with min. 2,10m height.
- Suitable for digital Bucky

1.4 Purpose

The diagnostic X-ray system PRS 300 VET TOUCH is designed for different routines for planable X-ray picturing within the veterinary medicine. The system is stationary and can be used for digital imaging.

1.5 Circle of user

The X-ray system PRS 300 VET TOUCH is only designed for the usage by professional users. Those users have to be qualified for the usage of diagnostic X-ray systems regarding the local law and have to be guided for the optimal handling, usage, operating. Also it is necessary to show up the allowed usage of additional medical products, objects and additional equipment.

The appropriate circle of users could be e.g.: X-ray technicians, X-ray assistants, Medical-technical X-ray assistants and Consultant for veterinary medicine.

2 Safety warnings



NOTE

Contains informations that have to be noted in order to operate.

Xxx



ATTENTION!

Contains information that can cause damage for nonconformity.

Xxx



WARNING!

Contains information, that can cause peronal injurys for nonconformity.

xxx



WARNING!

Warning of radioactive or ionisated rays. Contains information that can cause personal injurys for nonconformity.

xxx

Adjustments and calibrations which aren't characterized in the manuals, have to be done by the PROTEC support or a certified person with the technical description of the device.



NOTE

All manual that got delivered with the system have to be read carefully and any containing safety notes have to be read and followed detailed.



NOTE

With a digital implementation the manuals of CONAXX and RAPIXX have to be read carefully and any containing safety notes have to follow.



NOTE

The commissioning of the X-ray system can only be done if any precaution for the PROTECTion of the operator got checked and fulfilled. These PROTECTive steps could be e.g.: door contacts, marked areas, Dosimeter and safety clothes.



ATTENTION!

The manual contains any safety relevant information's for the commissioning of the system. Only certified staff is allowed to operate this system. All operating elements got secured with unique symbols. Any further information and manuals are on the delivered documentation-CD. These information's count as attachments to the printed manual and have to be considered.



NOTE

All operating elements on the console are marked by unique symbols, which are listed in the corresponding manuals. The building regulations have to be in terms of

the legal requirement. The X-ray system has to be checked by an authority related to the local law.



ATTENTION!

Injurious results for the patient may happen if the wrong SID is in use during exposure. When halving the distance the radiation dose is 4 times as high, called the inverse square law.

2.1 General Safety notes

2.1.1 Operating requirements



WARNING!

PROTECTIONclass I product

To lower the risk of electric shock, the device has to be connected to a supply network that's PROTECTED via PROTECTive conductor.

The power supply of the PRS 300 VET TOUCH can only be done by a direct connection to a mains socket that has a PROTECTive contact and a voltage of 230V 50/60Hz. The maximum consumption you can find in the technical description of the mobile X-ray device.

The X-ray system PRS 300 VET TOUCH is a product of PROTECTION class I. To lower the risk of electrical shocks the system has to be connected to a earthed power supply.

2.1.2 Operation

At malfunctions the X-ray system PRS 300 VET TOUCH isn't allowed to be used anymore, also immediately call the PROTEC support or an authorized service.

2.1.2.1 Operating Mode

The X-ray system PRS 300 VET TOUCH is designed for permanent use with breaks (60 seconds interval)

2.1.3 Operating personal

The X-ray system PRS 300 VET TOUCH can only be used by staff that got trained for diagnostic X-ray systems according to the local law.



NOTE

Only trained and authorized personal is allowed to work with the X-ray system PRS 300 VET TOUCH.

The user and service staff have to follow the warnings, notes and safety instructions that are on the device and inside the manuals, otherwise bad injuries can be the result.



NOTE

The operating personal has to be familiar with any warning that are on the X-ray system PRS 300 VET TOUCH. So the maximum PROTECTION for everyone and safe work is guaranteed.

2.1.4 Crushing and collision danger



ATTENTION!

While moving the tabletop it is necessary to take care of that no person, animal or object like chair, tables, carts etc. are within the obvious area. Disregarding this can cause injuries (compressions, contusions etc.) or damage to the device or other objects.

2.1.5 Explosion PROTECTION

The X-ray system PRS 300 VET TOUCH is not designed for operating in explosive hazardous areas.

2.1.6 Radiation PROTECTION

Radiation beams can threaten patients and other people nearby if not all regulation for such devices are observed.

Out of this the principles of radiation PROTECTION have the highest priority and have to be followed:

- **Keep distance of the source of radiation**
The dose decreases in square of the distance of the (punctual) source of radiation, e.g. double distance $\frac{1}{4}$ dose, three times of distance $\frac{1}{9}$ dose etc.
- **Keep the exposure time short**
The longer the exposure time the higher the dose, e.g. half exposure time is half of the dose.
- **Usage of shielding's and PROTECTive clothing's**
The PROTECTION value is increasing exponentially with the thickness of the shielding, e.g. 2 half-layer thicknesses are decreasing the (homogeneous) radiation to $\frac{1}{4}$, 3 half-layer thicknesses to $\frac{1}{8}$ and 10 half-layer thicknesses to less than $\frac{1}{1000}$ of the original value.
- **Don't grab inside the direct beam**
The dose within an unimpaired direct beam is ~ 100 times bigger than within the radiation area.
- **Use of personal dosimeter**
while working with radiation it is recommended to use a dosimeter.

In principle exposures have to be taken behind a safety wall. At exposures near generators look for the best available safety (gonadal PROTECTION capsule or lead covers). People that have to be near the patient must wear safety clothes (e.g. lead apron). The same applies for Service and maintenance work.

2.1.7 Ventilation

Make sure that the airflow of the X-ray generator isn't blocked by anything. The temperature of the close area may not exceed 40°C.

2.1.8 Interaction with other devices

There are no known interactions with other devices.

2.1.9 Electromagnetic environment and influence of other devices



ATTENTION!

The usage of other equipment, converter or cables other than the by PROTEC allowed or inside the manuals mentioned ones can cause increased electromagnetic emissions or a decreased electromagnetic resistance of the device which results in a faulty operating mode.



ATTENTION!

The usage of the PRS 300 VET TOUCH close to other devices or close to stacked devices should be avoided, because it can result in a faulty operating mode. if there is no other option that the above mentioned, the PRS 300 VET TOUCH and the other devices should be observed to make sure they work properly.



NOTE

The characteristics of this device, as determined by emissions, allow its use in the industrial sector and in animal clinics (CISPR 11, Class A). When used in residential areas (for which Class B is usually required by CISPR 11), this unit may not provide adequate PROTECTION for radio services. The user must take remedial measures such as implementation or reorientation of the device.

The PRS 300 VET TOUCH is designed for the professional use within a veterinary environment (e.g. Animal clinic, surgery center, stables ...)

3 Operating Elements and Displays

3.1 PRS 300 VET TOUCH

Overview of the components



* AED – Automatic Exposure Detection

3.1.1 Operating Elements and Displays of the mobile X-ray System

Detailed information's for the mobile X-ray system are inside the attached Usage instructions for this device.

3.1.2 Operating elements of the screen holder Ergotron LX

Detailed information for the screen holder Ergotron LX are inside the attached Usage instructions for this device.

3.1.3 Operating Elements and Displays of the CONAXX 2 Vet Software

Detailed information's for the CONAXX 2 VET software are inside the attached CONAXX 2 VET usage instructions.

3.1.4 Operating elements and displays of the RAPIXX system

Detailed information for the RAPIXX system are inside the attached RAPIXX usage instructions.

3.1.5 Operating elements and displays of the touchscreen

Detailed information for the touchscreen system are inside the attached usage instructions for the touchscreen.

4 Handling

4.1 Operation

Step	Description
1. Switch on the PRS 300 VET TOUCH	Start-up Order: <ul style="list-style-type: none"> - Generator - RAPIXX DR-System - PC/Laptop
2. Start CONAXX	
3. Select patient and picture within CONAXX	



4. Preparation of the shot in CONAXX

5. Setting Generator values

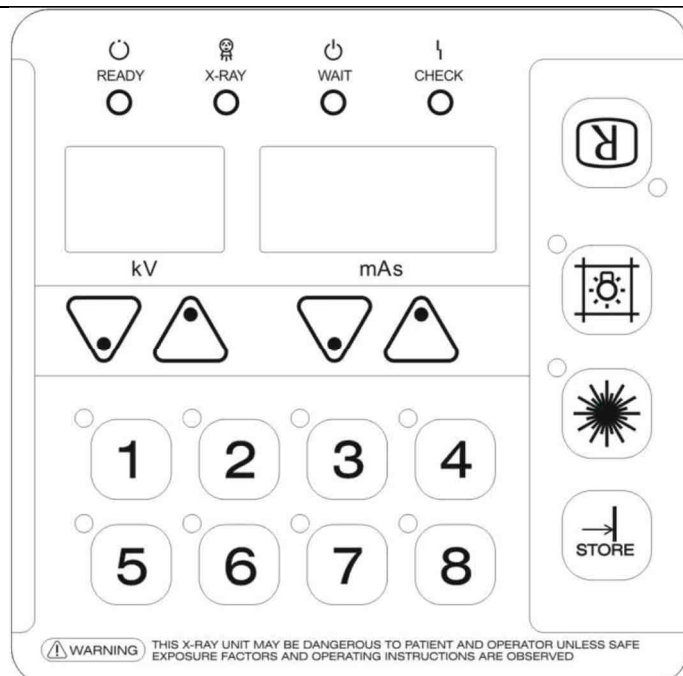

(View if the generator hangs on the generator holder)
 * The "R" key changes the reading direction of the display of the generator values. Pressing it again toggles the view back.

6. Positioning of the detector, tube and patient

7. Prepare the acquisition in CONAXX Starting exposure

8. Examine the Picture

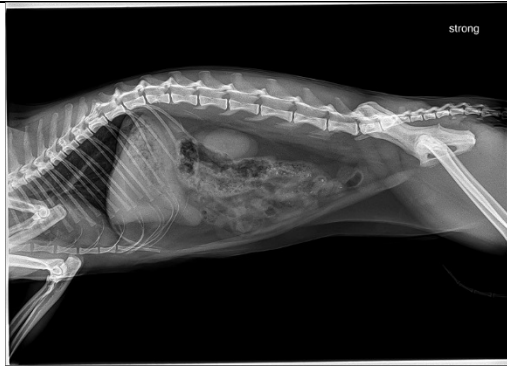

The detailed method is described inside the corresponding manual of the components.

4.1.1 Operation of the mobile X-ray System

Detailed information's for the mobile X-ray system are inside the attached usage instructions for the mobile X-ray system.

4.1.2 Operation of the screen holder Ergotron LX

Detailed information's for the screen holder Ergotron LX are inside the attached usage instructions for the screen holder Ergotron LX.

4.1.3 Operation of the CONAXX 2 VET software

Detailed information's for the CONAXX 2 software are inside the attached usage instructions for the CONAXX 2 VET software.

4.1.4 Operation of the RAPIXX system

Detailed information's for the RAPIXX system are inside the attached usage instructions for the RAPIXX system.

4.1.5 Operation of the Touchscreen

Detailed information for the Touchscreen are inside the attached usage instructions for the Touchscreen.

4.2 Function of the PRS 300 VET TOUCH



4.2.1 Off- and On-turning of the PRS 300 VET TOUCH

Turning on the PRS 300 VET TOUCH happens after turning on the following components separately:

1. Turning on the Generator
2. Turning on the RAPIXX system
3. Turning on the PC/Laptop and starting up the CONAXX 2 VET software

Turning off the system happens by doing the same vice versa.

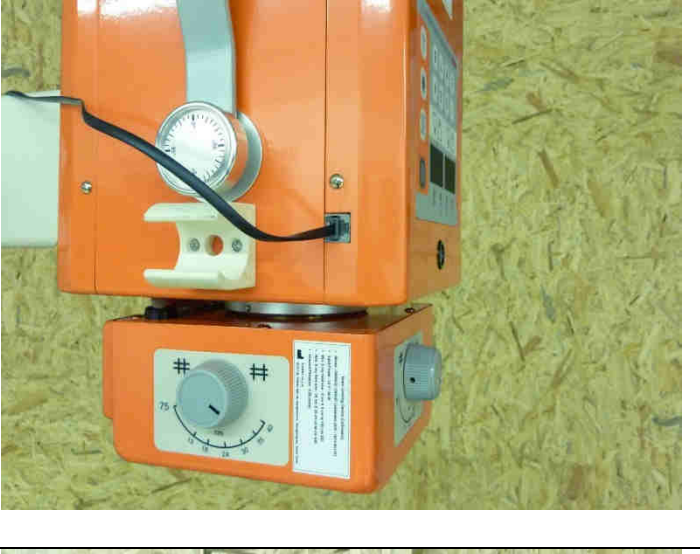
4.3 Remove the mobile X-ray generator to use it elsewhere

Step	Description
1. Disconnect the cable for the power supply	
2. Disconnect the cable for foot switch (The socket is positioned on the left side of the mobile X-ray generator)	
3. Loose the wing nut.	

-
4. Hang out the mobile X-ray generator



-
5. Connect the second power cord



-
6. Connect the hand switch



5 Safety and maintenance



WARNING!

Attention

Danger of electric Shock!

Before cleaning or disinfection turn off the X-ray generator and unplug the power supply. By doing this the X-ray system will be separated of the current source and the danger of receiving an electric shock is minimized.

5.1 Introduction

In this chapter are information for safety and maintenance that are necessary to make sure that the device is working right and reliable after the installation.

5.2 Cleaning and disinfection



NOTE

Attention

Possible material modification!

Be careful that while cleaning and disinfection absolutely no liquid is entering the casing, by doing this the chance of short circuits and/or corrosion will be minimized.



NOTE

At a X-ray system with RAPIXX implementation, you will find detailed information's for cleaning and disinfection in the attached manual and usage instruction RAPIXX, chapter 8.2.

5.2.1 Cleaning

The cleaning of the X-ray system PRS 300 VET TOUCH is very easy thanks to a high quality surface coating. Usually a dry cloth is enough.

It's not allowed to use corrosive, dissolving or grinding cleaning supplies, it can cause damage to the paint and device surface.

Cleaning the device surface and the painted parts with a wet cloth and a mild to slight alkaline cleaning supply (e.g. RBS® Neutral T) and wipe with a dry cloth.

Chrome parts can only be cleaned with a dry wool cloth.

5.2.2 Disinfection

For disinfection the practicable and current statutory provisions and regulations for disinfection and explosive PROTEction have to be taken into account.

For safety reasons it's not allowed to use a cleaning spray, since the spraying can enter the device and could cause short circuits and corrosion..

All components of the X-ray system PRS 300 VET TOUCH including the equipment can only be cleaned with a wipe disinfection and a suitable area disinfectant (e.g. Melsept® SF, 15 min. working time with 2% concentration). Information's of the producer of the disinfectants have to be taken into account.

It's not allowed to use flammable disinfectants.

While using disinfectants which can create explosive gas, the device can only be turned on after the gas has evaporated.

5.3 Reviewing and maintenance



WARNING!

It's prohibited to make any maintenance while the PRS 300 VET TOUCH is in use with a patient!

Any maintenance can only be done by professional staff that are trained or authorized by PROTEC.

5.3.1 Daily control before and while working

Please refer to the corresponding usage instruction of the component. Wear-resistant parts have to be replaced by original components.

5.3.2 Regular Checks

Please refer to the corresponding usage instruction of the component. Wear-resistant parts have to be replaced by original components.

5.3.3 Maintenance

The necessary maintenance have to be done every 6 months by a PROTEC service or an authorized service, to ensure the reliable functionality of the system.

PROTEC X-ray Systems GmbH isn't taking any legal responsibility for damage to the user or other people if the damage is caused by a lack of or not doing any maintenance.

Before the usage of the system the user has to be convinced that any safety appliance listed in the manuals is in proper function and the system is ready for operation.

Please refer to the technical description of the system and the corresponding components.

Wear-resistant parts have to be replaced by original components.

5.3.4 Warranty



NOTE

The current warranty's are attached in the order papers or in the, to the time of order, valid pricelist.

Excluded are repairs and spare parts at improper usage.

Warranty operations have to be done by special trained staff.

5.3.5 Product lifespan

The PRS 300 VET TOUCH has a life span of 10 years at a proper use and a regular maintenance of the PROTEC service or an authorized service. After reaching the end of the life span further use happens onto own responsibility.

5.3.6 Further information

Detailed information to the several chapters and for a safe use, transport or storage are inside the attached technical description of the system and the components.

5.3.7 Disposal instructions



The X-ray system PRS 300 VET TOUCH contains different plastics, oils and heavy metal. At disposal of exchange parts or the whole system the current regulations have to be observed. Please contact the service or a company specialized for disposing the components.



6 Power Supply



NOTE

The X-ray system needs the following power supply.
We recommend to use the mobile X-ray generator on a separate PROTECTed power supply to avoid an overload.

6.1 Operating conditions

6.1.1 Mobile Generator ORANGE 1060 HF

Power Supply: 220-240V~ @ 50Hz (single phase)
Power consumption: ca. 2,4kW

6.1.2 RAPIXX System

The power supply of the RAPIXX –DR system is inside the attached corresponding usage instruction.



WARNING!

To lower the risk of an electric shock, the device has to be plugged in on a supply network that has a PROTECTive conductor.

6.2 Electromagnetic Compatibility (EMC) after EN 60601-1-2



ATTENTION!

Portable HF-Communication equipment (Wireless devices) should not be used closer than 30cm (12 inch) to the designated components and cables of the PRS 300 VET TOUCH. Disregarding this can cause a decrease of the performance features of the device.



ATTENTION!

**The mobile X-ray system that is integrated in the PRS 300 VET TOUCH is sending electromagnetic waves while being in use, this can interfere with other devices or can be interfered by other devices.
For EMC-Directive and Declarations of Incorporation according to EN 60601-1-2 please refer to the separated usage instruction of the corresponding mobile X-ray system.**

7 Technical Data

7.1 Dimensions

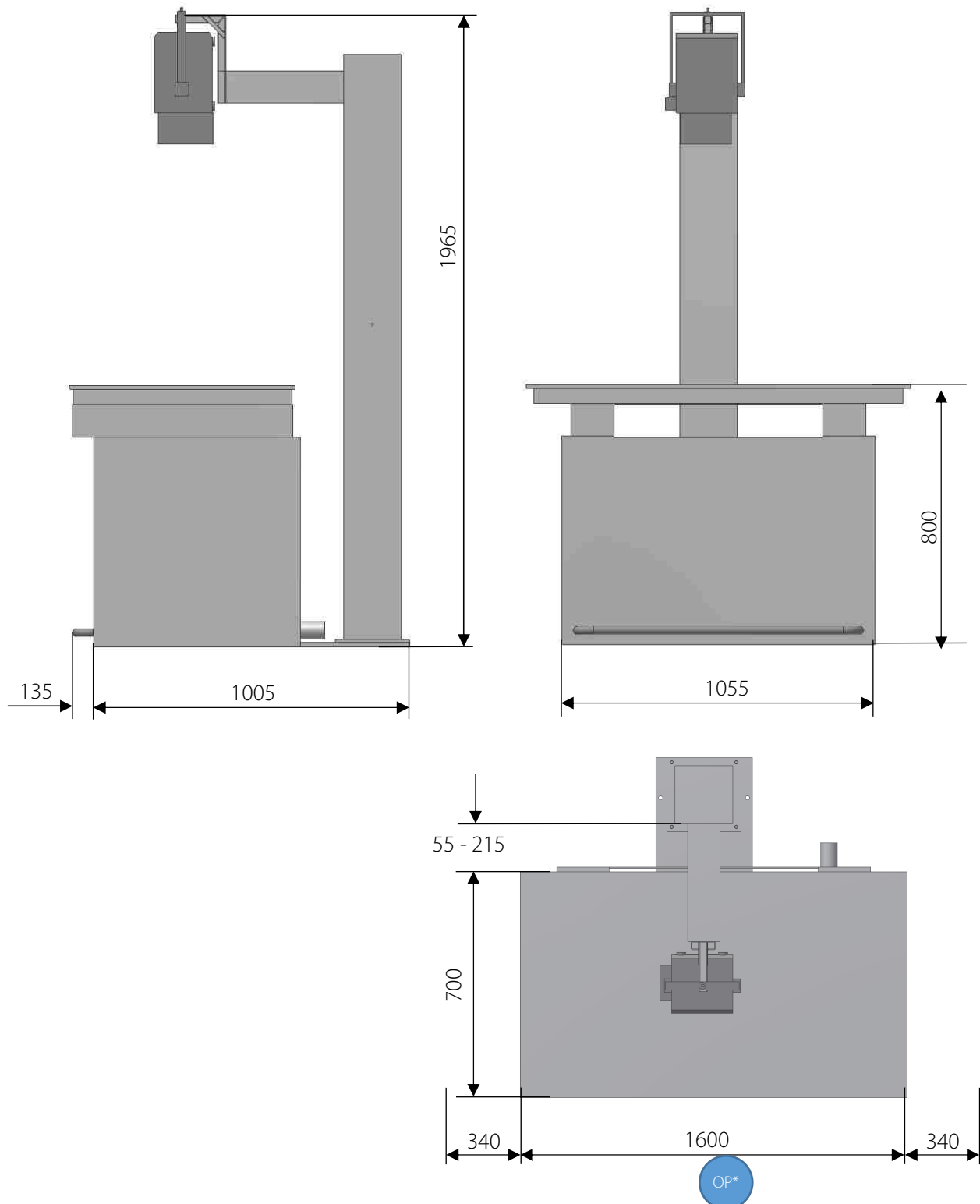

*OP Position of the operator

7.2 Attenuation equivalent



WARNING!

The X-ray system PRS 300 VET TOUCH can be delivered with different options on the Grid Entity/Bucky.

The attenuation factor must be determined at the final inspection at the customer. The variables like X-ray tube, Collimator etc. have influence to the factor. The attenuation value of the components can be read out of the accompanying documents of the component. The attenuation value has to be determined at the technical specifications. If the limits can't be kept please inform PROTEC immediately. If additional accessories are used it has a negative influence to the quality of the X-ray image.

The aluminum attenuation equivalent of the tabletop is typically 0,7 < 0,8 Al mm for carbon / 0,85 mm Al for composite fiber, according to EN 60601-1-3. Tested at 100 kV with a first half-value layer thickness (HVL) of 3,7 mm Al and typically 0,6 mm Al und <0,8mm Al according 21CFR § 1020-30 (n) with 100 kV and a first half-value layer thickness (HVL) of 2,7mm Al.

7.2.1 PROTECTION class

The X-ray system PRS 300 VET TOUCH match the PROTECTION class I and contains components of Type B (corresponding EN 60601-1).

7.3 Automatic cutoff dose

7.3.1 Digital System

The automatic cutoff dose depends on the detector.

For RAPIXX systems, see Installation- & User manual of the corresponding RAPIXX system (chapter 3.2; 3.3)

7.4 Environmental conditions

7.4.1 Environmental conditions for operation











Ambient temperature	+ 10°C to + 40°C
Relative humidity	30% to 75% (not condensing)
Air pressure	700hPa to 1060hPa

7.4.2 Environmental conditions for transport and storage

Ambient temperature	- 25°C to + 60°C
Relative humidity	10% to 95% (not condensing)
Air pressure	500hPa to 1060hPa

8 Descriptions of Image Signs, labels and Abbreviations

8.1 Image Signs

	Store dry
	Fragile, handle with care
	Top
	Attention, watch Accompanying Papers
	Observe Manuals
	Classification after EN 60601-1, Device of Type B
	Caution: Chance of crushing finger or hand
	Do not exceed max given load
	Warning, devices sends out ionizing radiation.
	Warning Laser beam. Avoid eye exposure.
	Warning of dangerous electrical voltage

8.2 Type signs

System

Bucky

Grid

X-RAY GRID	
Interspacier :	AL. (S/N:609708)
Size :	480 X 438 MM
Lines :	90 L/CM
Ratio :	12 : 1
F. D. :	110 CM

Mobile X-ray system

DIAGNOSTIC X-RAY UNIT

- MODEL : ANYPLX S
- SN : 0P5-60000
- INPUT POWER : AC 230 ~ 240 V~, 50 Hz : 2.5 kVA
- OUTPUT POWER : 40-100kV, 40mA, 0.32-100mA
- INSERTED X-RAY TUBE SN : 123456
- FOCAL SPOT : 1.2mm X 1.2mm

EcoRay Co., Ltd.
B-504, Woonim Lions Valley, 271-25, Gwan deup,
Gumcheon gu, Seoul, KOREA

SGF Technology
 3 Rutherford Square, Brackfield Industry Park, Livingston,
 West Lothian, Scotland EH54 9BU

CAUTION

- An experienced expert should operate the unit ONLY.
- The system should be away from water.
- Keep the unit away from the chemicals and explosive gas.
- Do not modify the equipment.
- Before use must read user manual.

CE
0434
MADE IN KOREA

Power supply Monitor

DELTA ELECTRONICS, INC. IS 13252 (Part 1) IEC 60950-1
 台达电子工业股份有限公司

MODEL: 型号: ADP-4000 B
 INPUT: 输入: 100-240 V~1.5A 50-60 Hz
 OUTPUT: 输出: 12V ~ 3.3A 0~40 LPS

Apparatus shall be connected to an earthed mains socket-outlet.
 Apparatet må tilkoples jordet stikkontakt.
 Apparatet skall anslutas till jordat uttag.
 Laitte on liitettävä maadoitetulla virtalähteen pistorasialla.
 The equipment must be connected to an earthed mains socket-outlet.
 L'appareil doit être branché sur une prise de courant munie d'une mise à la terre.
 Consumo de energía: 0.15 Wh
 En modo de espera: 0.072 Wh
 製造地: 中国/中国制造 MADE IN CHINA DOWP-CMA2

Power supply Laptop

DELL Inc. 戴尔 65w AC Adapter 19.5V 3.34A

DELL OUTPUT 输出/輸出: 19.5V ~ 3.34A
 INPUT 输入/輸入: 100-240V ~ 1.6A 50-60 Hz LPS

MODEL 型号/型號: DMS65M151-00
 AC/DC ADAPTER 电源适配器/交流式電源供應器
 Apparatet skall anslutas till jordat uttag när ansluts till ett nätverk.
 Laitte on liitettävä maadoitetulla virtalähteen pistorasialla.

IS 13252 (Part 1) IEC 60950-1

R-41013137

SAFETY MARK 100039-15

DELTA ELECTRONICS (HONGKONG) LTD.
 A/S Center: 080-854-0086
 012510

DELL HUI10104-10265
 电源适配器 AC/DC ADAPTER
 戴尔: DELTA ELECTRONICS (HONGKONG) LTD.
 A/S Center: 080-854-0086
 功耗: 0.15 Wh
 待机功耗: 0.072 Wh
 中国制造
 (MFG) 製造地: 台达电子工业股份有限公司 ADP-65TH FA

CN-01XRN1-48661-081-CIDC-A05
 Made in China
 DP/N 01XRN1

TOUCH Monitor

DELL IS 13252 (Part 1) IEC 60950-1

MODEL NO./型号/型號/型号: 5324070
 Input Rating: 输入/輸入/輸入: 100-240V~1.5A 50-60 Hz
 Output: 输出: 12V ~ 3.3A

Apparatus shall be connected to an earthed mains socket-outlet.
 Apparatet må tilkoples jordet stikkontakt.
 Apparatet skall anslutas till jordat uttag.
 Laitte on liitettävä maadoitetulla virtalähteen pistorasialla.
 The equipment must be connected to an earthed mains socket-outlet.
 L'appareil doit être branché sur une prise de courant munie d'une mise à la terre.
 Consumo de energía: 0.15 Wh
 En modo de espera: 0.072 Wh
 製造地: 中国/中国制造 MADE IN CHINA DOWP-CMA2

Laptop

IS 13252 (Part 1) IEC 60950-1

MODEL NO./型号/型號/型号: 5324070
 Input Rating: 输入/輸入/輸入: 100-240V~1.5A 50-60 Hz
 Output: 输出: 12V ~ 3.3A

Apparatus shall be connected to an earthed mains socket-outlet.
 Apparatet må tilkoples jordet stikkontakt.
 Apparatet skall anslutas till jordat uttag.
 Laitte on liitettävä maadoitetulla virtalähteen pistorasialla.
 The equipment must be connected to an earthed mains socket-outlet.
 L'appareil doit être branché sur une prise de courant munie d'une mise à la terre.
 Consumo de energía: 0.15 Wh
 En modo de espera: 0.072 Wh
 製造地: 中国/中国制造 MADE IN CHINA DOWP-CMA2

8.3 Positions of the signs and labels

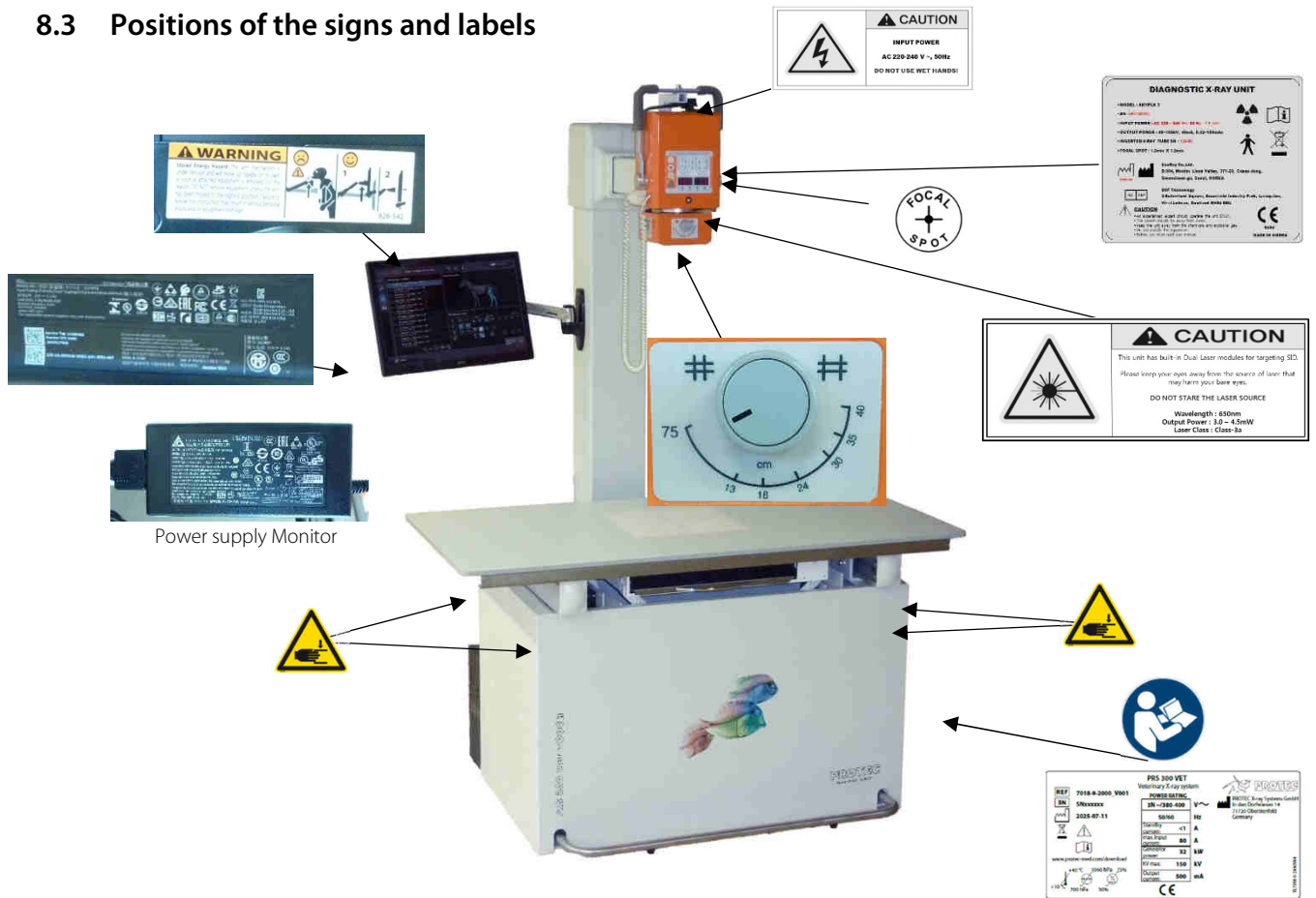

8.4 Abbreviation

mm	Millimeter
cm	Zentimeter
Lb	Pound
kg	Kilogramm
°C	Grad Celsius
hPa	Hektopascal
DIN	Deutsche Industrie-Norm
EN	Europäische Norm
CE	CE-Mark
Hz	Hertz
ED	On time (Einschaltdauer)
A	Ampere
SN	Serial Number