

PRS 500 C

Basic diagnostic X-ray system

Model/ID: 7073-9-8050
Basis-UDI-DI: 426050264X002ZD

Instructions for use

Ident. No. 5073-0-3002



CE 0297

**NOTE**

All sheets of this document contain proprietary and confidential information of PROTEC X-ray Systems GmbH and is intended for exclusive use by current PROTEC X-ray Systems GmbH customers. Copying, disclosure to other or other use is prohibited without the express written authorization of PROTEC's law department. Report any violations of this requirement to PROTEC X-ray Systems GmbH.

© 2025 PROTEC X-ray Systems GmbH, Oberstenfeld

These accompanying documents were created and distributed by the documentation department.
Comments and questions about the documentation, please contact:

PROTEC X-ray Systems GmbH

In den Dorfwiesen 14 | 71720 Oberstenfeld
Germany

Phone: (+ 49) 7062 – 92 55 0

Fax: (+ 49) 7062 – 92 55 60

E-Mail: protec@protec-med.com

Internet: www.protec-med.com

Table of contents

	Page
Table of contents	3
Document Effectivity	6
General Notes	8
Mechanical – Electric Warning	8
Radiation Warning	8
To the User	9
1 Product description	10
1.1 Introduction.....	10
1.2 Description.....	10
1.2.1 Equipment components.....	10
1.2.2 Hardware and network system requirements.....	10
1.2.3 Installation.....	11
1.2.3.1 Floor loading capacity.....	11
1.3 Performance characteristics.....	11
1.3.1 Patient positioning table.....	11
1.3.2 Floor-guided tube column stand.....	11
1.3.3 Vertical Bucky Wall Stand.....	12
1.4 Intended Use.....	12
1.5 Clinical Benefit.....	12
1.6 Patient Target Group(s).....	12
1.7 Medical Conditions to be diagnosed.....	12
1.8 Indication and Contraindication.....	13
1.8.1 Indications.....	13
1.8.2 Contraindications.....	13
1.9 Intended Operator Group.....	13
1.10 Declaration of Conformity.....	13
2 Safety Instructions	14
2.1 General safety instructions.....	15
2.1.1 Requirements for operation.....	15
2.1.2 Device operation.....	16
2.1.2.1 Operating type.....	16
2.1.3 Operating personnel.....	16
2.1.4 Crushing and Collision Hazards.....	16
2.1.5 Explosion Protection.....	16
2.1.6 Radiation Protection.....	16
2.1.7 Ventilation.....	17
2.1.8 Interaction with Other Devices.....	17
2.1.9 Electromagnetic Environment and Influencing of Devices.....	17
3 Control Elements and Displays	18
3.1 Main Switch of the PRS 500 C.....	18
3.2 Emergency Stop Switch of the PRS 500 C.....	18
3.2.1 Emergency Stop Switch Generator.....	18
3.3 Floor-guided tube column stand.....	19
3.4 Patient positioning table.....	20
3.5 Vertical Bucky Wall Stand.....	20
3.6 Control elements and device displays PROGNOST C.....	21
3.7 Control elements and device displays Ralco R302.....	21
3.8 Control elements and device displays Claymount Optica 20.....	21
3.9 Control elements and device displays VAREX RAD 14.....	21
3.10 Control elements and device displays VAREX RAD 21.....	21
3.11 Control elements and device displays IAE X76.....	21
3.12 Control elements and device displays Neusoft Venus.....	21

3.13	Control elements of Bucky, Grid Entity.....	21
3.14	Control elements and device displays of RAPIXX system.....	21
3.15	Control elements and device displays of CONAXX 2.....	21
4	Handling	22
4.1	Requirements before and during Operation.....	22
4.2	Operation of the PRS 500 C.....	22
4.2.1	Releasing the tabletop brake and positioning the tabletop.....	22
4.2.2	Positioning the image receptor from the wall stand.....	22
4.2.3	Exposures with the basic diagnostic X-ray system.....	22
4.2.3.1	Positioning/descending of the patient on/from the table top.....	22
4.2.3.2	Setting the X-ray unit on the centre of the Bucky, Grid Entity.....	22
4.2.3.3	Inserting a cassette into the cassette tray.....	22
4.2.3.4	Adjustment of the focus-film distance (SID).....	23
4.2.3.5	Adjusting the light-/beam field.....	23
4.2.3.6	Exposure preparation / Exposure releasing.....	23
4.2.3.7	Exposure with cassette on the table top.....	23
4.2.4	Operation at the wall stand.....	23
4.2.4.1	Adjustment of the X-ray unit to the centre of a cassette or Bucky/Grid Entity of an X-ray system wall stand (vertical centre beam).....	23
4.2.4.2	Adjustment of image-receptor distance (SID).....	23
4.2.4.3	Adjustment of the light-/ radiation field.....	23
4.2.4.4	Exposure preparation/ Exposure release.....	24
4.2.5	Operation RALCO R302.....	24
4.2.6	Operation Optica 20.....	24
4.2.7	Operation Neusoft Venus.....	24
4.2.8	Operation Bucky, Grid Entity.....	24
4.2.9	Operation VAREX RAD 14, RAD 21, IAE X76.....	24
4.2.10	Operation RAPIXX system.....	24
4.2.11	Operation CONAXX 2.....	24
4.3	Function of the PRS 500 C.....	24
4.3.1	Switching the PRS 500 C on and off.....	24
4.3.2	Power Box.....	25
4.3.3	Dosimetric Calibration.....	25
4.4	Exposure automatic.....	25
5	Safety and Maintenance.....	26
5.1	Introduction.....	26
5.2	Reusability.....	26
5.3	Cleaning and Disinfection.....	26
5.3.1	Cleaning.....	26
5.3.2	Disinfection.....	26
5.4	Inspection and maintenance.....	27
5.4.1	Daily monitoring prior and during the examination operation.....	27
5.4.2	Regular monitoring.....	27
5.4.3	Maintenance.....	27
5.4.4	Warranty.....	27
5.4.5	Product Service Life.....	27
5.4.6	Further Information.....	28
5.4.7	Applied Parts and Parts Considered as Applied Parts.....	28
5.4.8	Disposal.....	28
6	Electrical data.....	Fehler! Textmarke nicht definiert.
6.1	Electromagnetic Compatibility (EMC) according to EN 60601-1-2.....	29
6.1.1	Guidelines and Manufacturer's Declaration – Electromagnetic Interference.....	30
7	Technical Data.....	33
7.1	Dimensions.....	33
7.2	Patient positioning table.....	35
7.3	Bucky unit.....	35
7.4	X-ray stem tube support, floor stand.....	35

7.5	Vertical X-ray system image receptor stand.....	35
7.6	Attenuation Equivalent.....	36
7.6.1	Protection Type and Protection Class	36
7.7	Automatic cut-off dose	36
7.7.1	Analogue system.....	36
7.7.2	Digital system	36
7.8	Environmental	36
7.8.1	Environmental conditions during operation	36
7.8.2	Environmental conditions for shipping and storage.....	36
8	Description of symbols, labels and abbreviations.....	37
8.1	Symbols	37
8.1.1	Generator; Tube; collimator and optional accessories.....	38
8.2	Type label	38
8.3	Labels	38
8.4	Position of the signs and the labels.....	39
8.5	Abbreviations.....	39

**NOTE**

The information contained in this document conforms to the configuration of the equipment as of the date of manufacture. Revisions to the equipment subsequent to the date of manufacture will be addressed in service updates distributed to the PROTEC Technical Service Organization.

Document Effectivity

Revision No.	Date	List of effective pages	Comments	Author
1.0	2020-11-12	all	Original issue	
2.0	2021-02-17	7, 23	Radiation Warning, Power Box	
3.0	2021-02-25	Front Page, 10, 14, 18, 21, 24, 30, 34	Product picture, Warning mattress, mattress at characteristic table added, symbols and labels, cleaning, mattress added to technical data table	
4.0	2021-03-11	9, 10, 25, 26, 27, 28, 31, 32, 33, 34, 35	X-ray mattress description, compatible components, note X-ray mattress at characteristic table, Cleaning, disinfection, Life time, Applied part, symbols and labels, chapter power supply connection, X-ray mattress changed at technical data table, note attenuation equivalent	
5.0	2021-11-24	Front page, 10, 11, 12, 13, 14, 15, 16, 18, 19, 20, 21, 22, 23, 24, 25, 27, 28, 29, 31, 32, 33, 34, 35, 36, 37, 38, 39, 40	Product picture changed, X-ray mattress removed, Chap. 1 Product description revised, Chap. 2 Safety Instructions revised, Chap. 2.1.2.1 Mode of operation added, Chap. 3 control elements & device displays revised, Chap. 4 Handling / Operation revised, Chap. 5 Safety Maintenance revised, Chap. 6.2 electromagnetic compatibility revised, Chap. 7 Technical Data revised, Chap. 8 Description Symbols & Labels revised	MB
5.1	2022-03-29	35	7.5 Vertical X-ray system image receptor stand value revised	MB
5.2	2023-02-28	Chap. 1.2.1	Optional accessories corrected	ML
5.3	2023-06-23	36, 38; Chap.8.2	Value temperature updated, type label updated	MB

5.4	2024-04-12	Chap. 4.3.3 Chap. 4.2.1	Dosimetric calibration removed "Releasing tabletop brakes" added	TB DP
5.5	2025-07-18	all	First edition "PROTEC X-ray Systems GmbH"	DP
5.6	2025-08-13	All	Checked, Notes, Cautions and Warnings MDR content	ML

General Notes

**WARNING!**

In order to maintain the set and tested requirements of the 60601 series of standards, the ME system must not be modified during its actual operating life.

Mechanical – Electric Warning

**WARNING!**

All of the movable assemblies and parts of this equipment should be operated with care and routinely inspected in accordance with the manufacturer's recommendations contained in the equipment accompanying documents. Maintenance and service is only to be performed by customers authorized by PROTEC X-ray Systems GmbH.

Live electrical terminals are deadly.

Do not remove flexible high-tension cables from X-ray tube cover or high-tension generator and/or access covers from X-ray generator.

For all components of the equipment protective earthing means must be provided in compliance with the national regulations.

Failure to comply with the foregoing may result in serious or fatal bodily injuries to the operator or those in the area.

Radiation Warning

**WARNING!**

The component or system described within this document is part of a system for the intended generation of X-rays for medical diagnosis.

X-rays are ionizing radiation that can cause damage to living organisms (e.g., cancer or mutations).

X-rays generate a potential risk for both patients and operators. Therefore, the application of X-rays for a given medical issue, must aim at the minimization of radiation exposure for both groups of people.

The persons responsible for the application must have the necessary expertise in accordance with the legal regulations and requirements and apply the procedures for the safe operation of such systems. National regulations must also be observed during planning and installation.

X-rays are generated in the X-ray tube by strong deceleration of previously accelerated electrons, which emits energy in the form of electromagnetic waves. The intensity depends on the set parameters of voltage (kV), current (mA) and time (s) at the X-ray generator. The X-rays are emitted only at a beam exit window of the tube and are limited by the collimator mounted directly below.

The X-ray components used by PROTEC are devices only for human medical diagnostic applications and can be adjusted up to a maximum of 150 kV. Further information can be found in the respective technical data of the operating instructions of the generators, X-ray tubes and collimators.

To the User



NOTE

The user of these accompanying documents is required to carefully read through and carefully consider the instructions, warnings and cautions contained therein before starting operation.

Even if you have already operated similar systems, changes in the design, production and functional routine of the system described here may have been made, which have a significant influence on the operation.

Although the product was subject to a risk analysis and the design corresponds to the current state of the art, residual risks remain in clinical use. These are displayed in the following Instructions for use by application limits, contraindications, warnings and precautions.

Assembly and service works on the system described here must be carried out by authorised and qualified personnel from PROTEC X-ray Systems GmbH. Assembly personnel and other persons who are not employees of the technical service department of PROTEC X-ray Systems GmbH are requested to contact the local branch of PROTEC X-ray Systems GmbH before assembly or service work is started. For assembly and service works, it is necessary to use the "Technical Description" of the product and to observe the points it contains.



NOTE

The usage of the product in combination with accessories not authorized by PROTEC is forbidden.

1 Product description

1.1 Introduction

This instructions for use describe the performance characteristics and operational aspects, required for efficient and effective use of the PRS 500 C radiographic system.

Prior to working with the basic diagnostic X-ray system PRS 500 C, the entire operating instructions must be read through, in particular the safety instructions and the chapter "Handling".

1.2 Description

The PRS 500 C X-ray system is a complete radiography system for versatile applications and high workloads. The stationary X-ray system table with floating tabletop supports patient loads up to 250 kg. The complete system provides excellent image acquisition quality and is ideally suited for all types of X-ray examinations in radiology practices, centres, clinics and hospitals – regardless of whether analogue or digital imaging methods are used.

1.2.1 Equipment components

The PROTEC X-ray system PRS 500 C persists of the following system components:

- Stationary patient positioning table with floating table top,
- Floor railed tube column with control arm,
- Bucky unit,
- Vertical Bucky Wall stand,
- X-ray generator,
- X-ray tube assembly with housing,
- Anti-scatter grid
- Collimator

Optional components

- Measuring chamber (Solid State)
- Dose area product meter system
- Different direct X-ray-systems (RAPIXX-series)
(consisting of DR-detector, Interface Box, and Software)

Optional accessories

The PRS 500 C can be equipped or customized with the following accessories:

- Mattress
- Patient extending handle*

*Accessories with medical purpose

Accessories that might affect the electromagnetic compatibility

- Network cable (note the max. length in the documents)
- RAPIXX data cable (note the max. length in the documents)
- WLAN-Router or Access Point (only use devices that has an authorization by PROTEC)

1.2.2 Hardware and network system requirements

If an X-ray system with optional system components for digital use is involved, it should be ensured that the country-specific requirements for data protection and IT security are met.

The system requirements for the optional system components (RAPIXX series) can be found in the current document supplied, "EN_5330-0-0026_CONAXX2_System_Requirements".

1.2.3 Installation



NOTE

The installation of the PRS 500 C must be performed by PROTEC customer service department or a service authorized by them.

This X-ray system PRS 500 C must be installed in a shielded X-ray room, which complies with national radiation protection regulations.

The room intended for the installation of the X-ray system must be prepared.

This may need to include modifications for laying electrical connections to a central distribution cabinet. The electrical and structural design of the room intended for the generator must comply with national regulations (electrical and floor weight loading).

For more information, please see separate "Installation manual" of the PRS 500 C.

Contact information of persons qualified to perform installations are available upon request from:

PROTEC X-ray Systems GmbH

In den Dorfwiesen 14 | 71720 Oberstenfeld
Germany

Telephone: +49 (0) 7062 – 92 55 0

Fax: +49 (0) 7062 – 92 55 60

E-Mail: protec@protec-med.com

Internet: www.protec-med.com

1.2.3.1 Floor loading capacity



NOTE

The X-ray system is primarily made of metal pieces. This has a corresponding effect in the weight of the device.

The X-ray system PRS 500 C has a weight of **665 kg** (incl. generator).

Every technician is obliged to check the floor loading capacity. Also raised floors and hollow floors must be taken into account.

1.3 Performance characteristics

1.3.1 Patient positioning table

- Floating table top
- Table top colour – white
- Electromagnetic table top brake for effortless patient positioning
- Low optimized distance between the table top surface and the film (detector) surface
- Large adjustment range of the table top for position of the patient
- High reliability
- Prepared for the installation of a Bucky with anti-scatter grid and 3-field measuring chamber intended for the use with automatic exposure control
- Useable for variable cassette/detector sizes. Formats from 13 cm x 18 cm (5" x 7") to 43 cm x 43 cm (17" x 17"), depending on analogue or digital use.

1.3.2 Floor-guided tube column stand

- Ceiling-free column stand intended for use within rooms with a ceiling height of at least 2.20 meters
- Wide range of application
- Small wall distance allows good space utilization

- Control elements of the control unit are well placed and easy to activate
- Reproducible positioning of the X-ray tube assembly when rotating around the tube arm axis by angle indication
- Vertical range of travel of the focus height from 40.0 cm up to 176.5 cm during horizontal beam projection
- Electromagnetic brakes for the longitudinal movement of the column stand, the vertical movements of the carrying arm, the rotational movements of the X-ray tube assembly around the axis of the carrying arm +/-135°.
- Safety connector for automatically centring the X-ray tube assembly and the Bucky.

1.3.3 Vertical Bucky Wall Stand

- Space saving with minimal installation area
- Wall – floor mounting of only floor mounting
- cassette loading from the right or left side
- Useable for variable cassette/detector sizes. Formats from 13 cm x 18 cm (5" x 7") to 43 cm x 43 cm (17" x 17"), depending on analogue or digital use.

1.4 Intended Use

The basic diagnostic X-ray systems of the PRS 500 series are intended for various routine applications in planar X-ray imaging in human medicine. They are stationary systems that can be used for both analogue and digital imaging. They are stationary systems that can be used for both analogue and digital imaging.

1.5 Clinical Benefit

The clinical benefit of using diagnostic X-ray systems in human medicine is the generation of conventional two-dimensional X-ray images for creation or specification of findings as a basis for treatment decisions.

1.6 Patient Target Group(s)

The intended patient group includes all people for whom a justifying indication for a medical X-ray has been given by a physician with the necessary expertise in radiation protection.

There are no general or fundamental restrictions on the patient group regarding age, gender, origin and patient condition.

1.7 Medical Conditions to be diagnosed

A complete list of indications is not feasible for conventional radiography, because the spectrum of conventional X-rays is very diverse and can vary in the course of medical-technical progress.

Examples for medical conditions to be diagnosed:

- Bone fracture or bony injuries of the skeletal system or pathological changes of bony tissues.
- Monitoring of the correct setting of the fractures
- Dislocations and bony ligament ruptures of the musculoskeletal system
- Degenerative, inflammatory, traumatic and tumorous diseases and changes of the musculoskeletal system.
- Defective position and malformations of the skeletal system.
- Thoracic and pulmonary symptoms (thorax exposures)
- Sclerosis
- Inflammatory and expansive processes of the mucosa, cranial bones and paranasal sinus extension.
- Disease of the abdominal cavity (e.g. acute abdomen, abdominal overview radiography, urethrogram, cystogram).

1.8 Indication and Contraindication

1.8.1 Indications

According to §83 of the German radiation protection law (StrlSchG), an X-ray examination is only justified if the patients benefit from X-ray diagnostics outweighs the radiation risk. The examination method, means the conventional X-ray with the PRS 500 C System, must be suitable to answer the diagnostic question and no other more suitable alternative method is available.

Accordingly, it is also described by the International Atomic Energy Agency (IAEA) in the document Radiation Protection and Safety of Radiation Sources: International Basic Safety Standards (Requirement 37: Justification of medical exposures). It also refers to the need to consider national or international guidelines for the justification of a medical exposure.



NOTE

Even if, according to the justifying indication, the benefit predominates the radiation risk, it must not be disregarded that there are residual risks due to ionising radiation and that undesirable side effects may occur. Ionising radiation (X-radiation) can damage the genome and, in the long term, lead to cancer and mutations and thus damage the human body.

1.8.2 Contraindications

There are no absolute contraindications for conventional X-rays. But it is not allowed to make any exposures on humans when they are not medically indicated (see justification of medical exposures,). For pregnant women and children it is important to consider if the exposure is really necessary. It should be avoided if possible.

1.9 Intended Operator Group

The X-ray systems of the PRS 500 series are intended exclusively for use by professional users who are trained in the operation of diagnostic X-ray systems in accordance with the respective national regulations and who are familiar with the proper handling, use and operation and also have been instructed in the permitted conjunction with other medical products, objects and accessories. Appropriate users can be, for example: X-ray technicians, X-ray assistants, medical technical X-ray assistants, surgeons, casualty surgeons, orthopaedists and other trained medical personnel.

1.10 Declaration of Conformity

CE 0297

This product is in conformity with the requirements of the Council Directive 93/42/EEC of 06/14/1993 concerning medical devices, including all applicable corrigenda.

The declaration of conformity is available upon request from:

PROTEC X-ray Systems GmbH
In den Dorfwiesen 14 | 71720 Oberstenfeld
Germany

Telephone: +49 (0) 7062 – 92 55 0

Fax: +49 (0) 7062 – 92 55 60

E-Mail: protec@protec-med.com

Internet: www.protec-med.com

2 Safety Instructions

**NOTE**

Contains information that must be observed during operation.

xxx

**CAUTION!**

Contains information which, if not observed, can cause property damage.

xxx

**WARNING!**

Contains information which, if not followed, can cause personal injury.

xxx

**WARNING!**

Warning of radioactive substances or ionizing radiation. Contains information which, if not observed, can cause personal injury.

xxx

Settings and calibrations that are not described in these instructions for use must be carried out using the technical description of the device by PROTEC service department or a service company authorized by them.

**NOTE**

All instructions supplied with the PRS 500 C must be observed and the safety instructions contained therein must be carefully read and adhered to.

**NOTE**

After the initial installation, the commissioning must be recorded with the PROTEC acceptance protocol FB-04-07A4.3.

**NOTE**

In the case of a digital system, the instructions for CONAXX and RAPIXX must be observed and the safety instructions contained therein must be carefully read and adhered to.

**NOTE**

The X-ray system may only be commissioned if all safety measures for operator protection have been met and checked. These protective measures can include door contact, designated area, dosimeter, protective clothing, etc.

**CAUTION!**

The instructions for use contain all the information relevant to safety in order to generally put the PRS 500 C into operation. The device may only be operated by appropriately trained and trained personnel. In this context, operation is ensured by clear symbols on the control elements. All further information and instructions can be found on the supplied data carrier (USB, CD or DVD). This information applies in its entirety as an appendix to these instructions for use and must be observed

**NOTE**

All operating elements are marked on the operating console and on the swivel arm or wall stand with clear symbols which are described in detail in the corresponding instructions for use. The legal requirements regarding the building regulations for an X-ray area must be met. The X-ray system must be tested in accordance with the regulations in force in the country of installation and approved by the appropriate body.

**CAUTION!**

If the wrong SID is in use for exposures, it can result in personal injuries for the patient. The inverse square law applies here. Halving the distance will cause a radiation dose 4 times higher.

**WARNING!**

X-rays may not be performed on persons without a medical justifying indication. In the case of pregnant women and children, it must be carefully considered whether an exposure is necessary. It should be avoided if possible.

2.1 General safety instructions

2.1.1 Requirements for operation

**WARNING!**

The PRS 500 C is a protection class I device (according to EN 60601-1). To avoid the risk of an electric shock, this device may only be connected to a supply network with a protective earth conductor. The power supply for the components of the PRS 500 C X-ray system is established exclusively by direct connection to the X-ray generator or the Power Box and is permanently connected there. The X-ray generator or the Power Box must have at least 2 connections for 230V 50/60Hz. The X-ray generator of the X-ray system is connected to the power supply (see Technical Description of the X-ray generator). To reduce the risk of electric shock, the system must be connected to a supply network with protective grounding. The system has no on/off switch. It is switched on and off directly by switching on the X-ray generator or by the switch on the power box. To disconnect any electrical voltages from the X-ray system, the connected X-ray generator or the power box must be switched off.

2.1.2 Device operation

In the event of malfunctions, the PRS 500 C X-ray system must no longer be used and PROTEC's customer service department or a service department authorized by PROTEC must be notified.

2.1.2.1 Operating type

The PRS 500 C is not designated for continuous use.

The separate maximum operating times must be taken from the individual components.

2.1.3 Operating personnel



NOTE

Only trained and authorized personnel are allowed to work on the PRS 500 C.



NOTE

The operating personnel must be familiar with all warning signs attached to the PRS 500 C. They are used for your own safety and that of others and ensure proper operation.

2.1.4 Crushing and Collision Hazards



WARNING!

It must be ensured that when operating the moving parts of PRS 500 C, no persons or objects are in the obvious danger area of the device. If not observed, it can result in personal injury or damage to the PRS 500 C or other objects.

2.1.5 Explosion Protection

The radiographic system PRS 500 C is not designated for use within areas with explosive hazards.

2.1.6 Radiation Protection

X-rays can pose a risk to patients and other people if the regulations for the operation of such systems are not observed.

For this reason, the principles of radiation protection must have top priority and must be strictly adhered to:

- **Keeping distance from the radiation source**
The dosage is reduced as a factor of the square of the distance from a (dot shaped) radiation source. Double the distance ¼ dose, triple the distance 1/9 dose, etc.
The dose decreases with the square of the distance from a (point) radiation source, i.e. double distance 1/4 dose, triple distance 1/9 dose, etc.
- **Keeping exposure time as short as possible**
The longer the exposure time, the higher the dose, i.e. halving the exposure time leads to halving the dose, etc.
- **Utilize shielding and protective clothing**
The protection value increases exponentially with the thickness of the shielding, i.e. 2 half-value layers weaken a (homogeneous) radiation to 1/4, 3 half-value layers to 1/8 and 10 half-value layers to less than 1/1000 of the initial value.
- **Do not reach into the direct X-Ray beam**
The dose in the non-attenuated direct beam is about 100 times greater than that in the area of scattered radiation.
- **Utilize personal dosimeters**
When working with radiation, dosimeters should be used for monitoring that are appropriate for the activity.

The X-Ray exposures are principally triggered from behind a protective wall. When taking exposures near the genital organs use the maximum available protection (e.g. gonad protectors or lead covers).

Persons who have to be in the vicinity of the patient must wear protective clothing (e.g. lead aprons). The same applies to maintenance and repair work.

2.1.7 Ventilation

It is important to ensure that the air exchange of the X-Ray generator within the system is not hindered. The ambient air temperature is not allowed to exceed 40°C.

2.1.8 Interaction with Other Devices

Interaction with external devices is not known.

2.1.9 Electromagnetic Environment and Influencing of Devices



CAUTION!

The use of other accessories, other converters and other cables than those specified by PROTEC or provided in the documentation of the component manufacturer can result in increased electromagnetic interference or reduced electromagnetic immunity of the device and lead to defective operation.



CAUTION!

The use of the PRS 500 C immediately next to other devices or with other devices in a stacked form should be avoided, as this could result in defective operation. If use in the manner described above is nevertheless necessary, the PRS 500 C and the other devices should be observed to ensure that they are working properly.



NOTE

The properties of this device, determined by emissions, allow its use in industrial areas and in hospitals (CISPR 11, class A). When used in residential areas (for which class B is usually required by CISPR 11), this device may not provide adequate protection for radio services. The user may need to take remedial measures such as relocating or realigning the device.

The PRS 500 C is intended for use in an environment in professional health care facilities (e.g., clinics, surgery centres, physiology practices ...).

3 Control Elements and Displays

3.1 Main Switch of the PRS 500 C

The PRS 500 C is switched on and off via a mini console (e.g. of the Venus-32/50-R, see Fig. 3.1a), a normal control console (e.g. of the Venus-32/50-R, see Fig. 3.1b) of the X-ray generator or via the switch on the power box (see Fig. 3.1c).

The illustrations of the mini and operating consoles may differ depending on the system configuration. However, the symbols for switching on or off are identical.

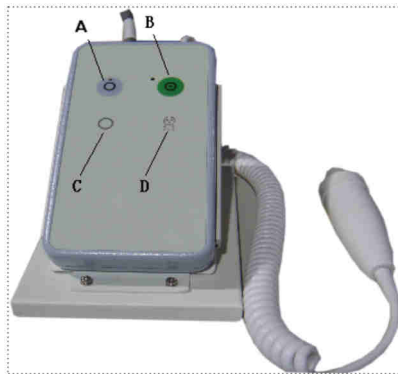

Fig. 3.1a Mini-console Venus-32/50-R

A	Switching off the PRS 500 C
B	Switching on the PRS 500 C
C	Ready for radiation
D	Radiation reading

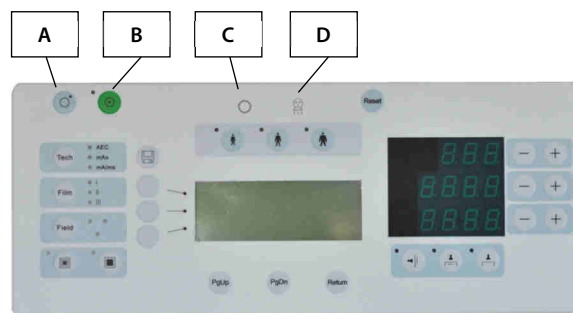

Fig. 3.1b Operating console Venus-32/50-R

A	Switching off the PRS 500 C
B	Switching on the PRS 500 C
C	Ready for radiation
D	Radiation reading



Fig. 3.1c Power Box Switch

OFF	Switching off the PRS 500 C
ON	Switching on the PRS 500 C

3.2 Emergency Stop Switch of the PRS 500 C

The X-ray system PRS 500 C has no emergency stop switches, which can be used to bring the device to an immediate standstill and disconnect it from the power supply.

3.2.1 Emergency Stop Switch Generator

For the emergency stop switch position of the corresponding X-ray generator, please refer to the enclosed generator instructions for use.

3.3 Floor-guided tube column stand

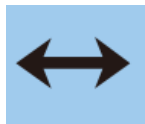
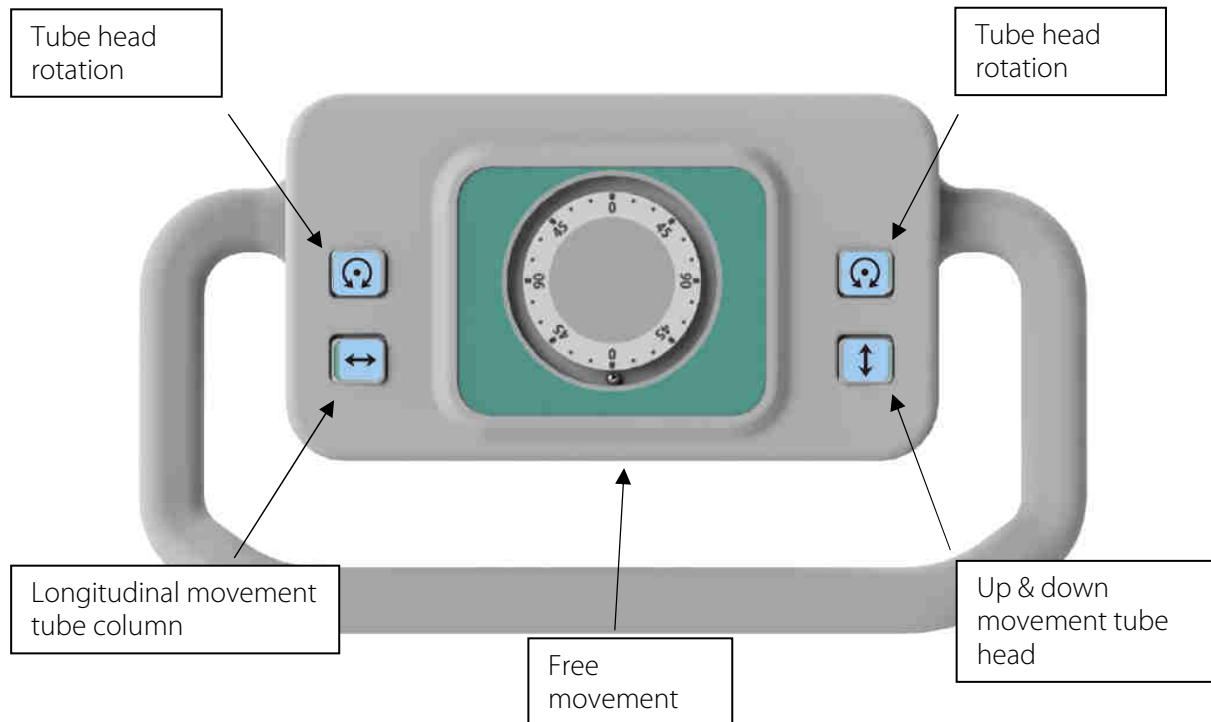

Longitudinal movement tube column

Brake for the longitudinal/horizontal movement of the tube column

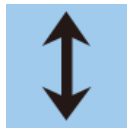

Tube head up/down

Brake for the height positioning /vertical movement of the tube head



Tube Rotation

Brake for the tube head rotation around the carrying axis

Free movement (sensor beneath the tube head)

Permits the horizontal movement of the tube column and vertical movement of the tube head

3.4 Patient positioning table

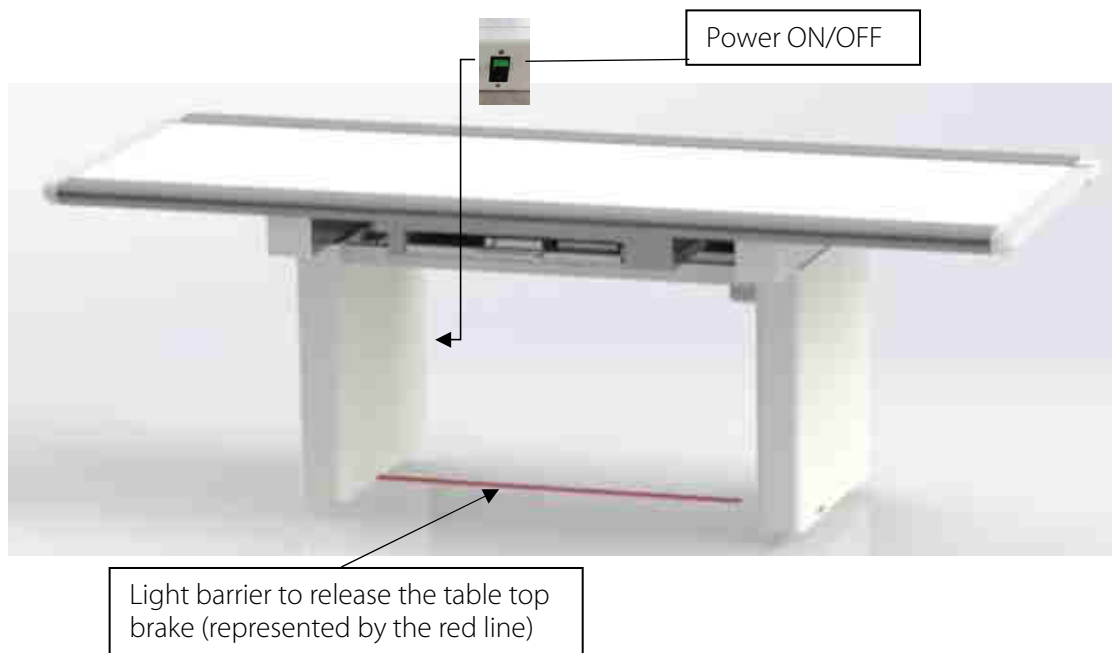

CAUTION!

By activating the light barrier, the electromagnetic table top brakes are supplied with power that they switch off and the table top can be moved. It must be ensured that no objects are continuously laying in the light barrier and permanently trigger it, otherwise the brakes are supplied with continuous current and could get damaged.

3.5 Vertical Bucky Wall Stand

Brake for the vertical movement of the wall stand Bucky.

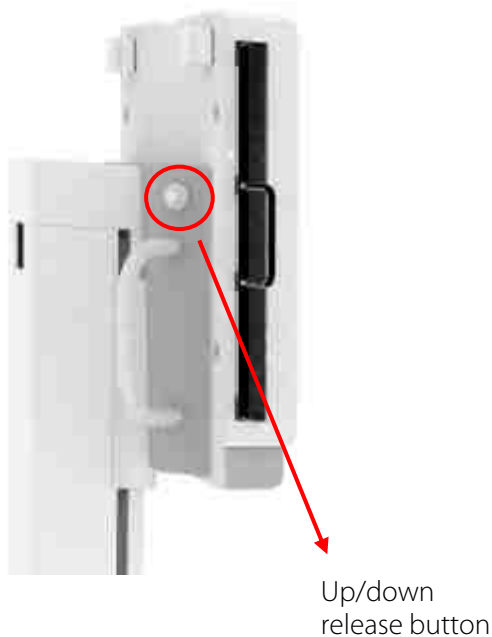

3.6 Control elements and device displays PROGNOST C

Detailed information please find in the enclosed instructions for use of the PROGNOST C.

3.7 Control elements and device displays Ralco R302

Detailed information please find in the enclosed instructions for use of the Ralco R302.

3.8 Control elements and device displays Claymount Optica 20

Detailed information please find in the enclosed instructions for use of the Claymount Optica 20.

3.9 Control elements and device displays VAREX RAD 14

Detailed information please find in the enclosed instructions for use of the VAREX RAD 14.

3.10 Control elements and device displays VAREX RAD 21

Detailed information please find in the enclosed instructions for use of the VAREX RAD 21.

3.11 Control elements and device displays IAE X76

Detailed information please find in the enclosed instructions for use of the IAE X76.

3.12 Control elements and device displays Neusoft Venus

Detailed information please find in the enclosed instructions for use of the Neusoft Venus.

3.13 Control elements of Bucky, Grid Entity

Detailed information please find in the enclosed instructions for use of the Bucky.

3.14 Control elements and device displays of RAPIXX system

Detailed information please find in the enclosed instructions for use of the RAPIXX system.

3.15 Control elements and device displays of CONAXX 2

Detailed information please find in the enclosed instructions for use and installation manual of the CONAXX 2.

4 Handling

4.1 Requirements before and during Operation

It must be ensured that the principles of radiation protection are always observed (see chapter 2.1.6).

It must be ensured that the surfaces that come into contact with patients are disinfected before the X-ray examination of each patient (see chapter 5.3).

4.2 Operation of the PRS 500 C

4.2.1 Releasing the tabletop brake and positioning the tabletop



NOTE

Prior to patient positioning, the X-ray unit must be brought into the required exposure position.



WARNING!

The tabletop may only be locked when the tabletop is in the rest position, not while it is being moved.

1. Release the tabletop brakes by interrupting the light barrier with your foot.
2. Move the floating tabletop to the desired position by hand while keeping the light barrier interrupted.
3. When the tabletop is in the rest position, release the light barrier and the tabletop will be locked again by the brakes.

4.2.2 Positioning the image receptor from the wall stand

By pressing the release button on the wall stand, the brakes for the grid device are released, the grid device can be moved by hand

4.2.3 Exposures with the basic diagnostic X-ray system

4.2.3.1 Positioning/descending of the patient on/from the table top

- Move the table top to a position to make it easy for the patient to climb onto/from the table surface.
- The patient should position himself in the middle of the table top and remain in this position.

4.2.3.2 Setting the X-ray unit on the centre of the Bucky, Grid Entity

- By pressing the button "longitudinal movement tube column" (see figure operating unit), release the brake for the longitudinal movement.
- Grab both handles on both sides of the command arm.
- Move the X-ray tube assembly in the longitudinal direction along the radiographic X-ray table until the Bucky/Grid Entity snaps into the safety coupling.

4.2.3.3 Inserting a cassette into the cassette tray

- A film cassette may be placed into the cassette tray, after the X-ray tube assembly is positioned.
- Pull out the cassette tray by its handle from the Bucky/Grid Entity unit until it hits the forward stop.
- Rotate the latch for opening/closing the clamping device, for lateral fixation of the cassette, counter clockwise to unlock it.
- Open the cassette clamps far enough to insert a cassette of the desired size.
- Insert the cassette, aligning its centreline with the notch on the clamp, or after engaging the cassette positioner in the notch corresponding to the cassette size (13 cm, 18 cm, 24 cm, 30 cm, 35 cm, 40 cm or 43 cm), push the cassette toward the cassette positioner.
- Push the cassette clamps against the cassette and rotate the latch into the locked position.
- Push the cassette tray fully into the Bucky/Grid Entity.

4.2.3.4 Adjustment of the focus-film distance (SID)

- Set the X-ray unit with a tape measure at the collimator or the display on the tube head to the desired focus-film distance (SID).
- Press the button "Tube head up/down" to release the brake for the height adjustment of the X-ray tube assembly.

4.2.3.5 Adjusting the light-/beam field

- Switch on the collimator light to check the opening of the collimator shutters to the used cassette.
- Use the adjusting knobs to set the collimator shutters to the size of the cassette being used. The setting is made on the scale for the corresponding focus-film distance (SID). This limits the light-/beam field to the cassette size used.

4.2.3.6 Exposure preparation / Exposure releasing

- Select the application device (X-ray system table with Bucky, Grid Entity) on the X-ray generator control panel
- Set the desired organ program or exposure data and initiate the exposure by pressing the exposure preparation /release controls.

4.2.3.7 Exposure with cassette on the table top

- Place a cassette to the desired position on the table top.
- Move the X-ray tube to the desired SID position.
- Turn on the collimator light and view the opening of the collimator shutters to the cassette size.
- Adjust the light field with the adjusting knobs onto the size of the used cassette, that the radiation field will be limited to the size of the cassette.
- Select the application device (X-ray system table with Bucky, Grid Entity) on the X-ray generator control panel
- Set the desired organ program or exposure data and initiate the exposure by pressing the exposure preparation /release controls.

4.2.4 Operation at the wall stand

4.2.4.1 Adjustment of the X-ray unit to the centre of a cassette or Bucky/Grid Entity of an X-ray system wall stand (vertical centre beam)

- By pressing button "tube head rotation" the brake for the rotation X-ray tube assembly will be released.
- Swing the X-ray unit to the X-ray system wall stand.
- Set the Bucky, Grid Entity on the wall stand to the size of the patient (see figure vertical Bucky wall stand).

4.2.4.2 Adjustment of image-receptor distance (SID)

- Release brake of the tube column by pressing button "Longitudinal movement tube column" and adjust the source to image-receptor distance (SID) which will be used for the exposure. Notice the focus area of the scanning unit, Bucky and Grid Entity. Those settings must be done with the measuring tape inside the collimator or with the markings on the upper guidance of the column.

4.2.4.3 Adjustment of the light-/ radiation field

- By using the button "Up/down movement tube head" the brake for adjusting the height will be released.
- Set the collimator to the requested height and align it to the Bucky by using the light-beam localizer.
- Release Button "Up/down movement tube head" to activate the height-adjustable brake for the X-ray tube head assembly.
- Activate the light-beam of the collimator to check the opening of the shutters to the used cassette.
- Adjust the shutters with the adjusting knobs of the collimator to the size of the used cassette. The settings will be done on the scale to the according cassette source to image-receptor distance (SID). So the light-/ radiation field is limited to the according cassette.

4.2.4.4 Exposure preparation/ Exposure release

- Select the used device on the console of the generator (vertical wall stand).
- Select the requested organ program or the requested exposure details and start the exposure by using the control element for exposure preparation/ release.

4.2.5 Operation of the collimator RALCO R302

Detailed information please find in the enclosed instructions for use of the Ralco R302.

4.2.6 Operation of the collimator Optica 20

Detailed information please find in the enclosed instructions for use of the Optica 20.

4.2.7 Operation of the generator Neusoft Venus

Detailed information please find in the enclosed instructions for use of the Neusoft Venus.

4.2.8 Operation of the Bucky, Grid Entity

Detailed information please find in the enclosed instructions for use of the Bucky.

4.2.9 Operation of the tube VAREX RAD 14, RAD 21, IAE X76



NOTE

The X-Ray tube must be warmed-up every day to prolong the life of the X-ray tube and prevent flashovers. If you do not have the initial preparation procedure recommended by the X-ray tube manufacturer, proceed as follows:
Set Generator: Large focal spot, 200mA, 40mAs
Run 8 exposures. Start at 50 kV and increase in 10 kV increments to 120 kV (exposure every 30 seconds, otherwise flashover may occur in the tube).
See also the instructions for use of the respective generator and CONAXX 2.

Detailed information please find in the enclosed instructions for use of the VAREX RAD 14, RAD 21, IAE X76.

4.2.10 Operation of the RAPIXX system

Detailed information please find in the enclosed instructions for use of the RAPIXX system.

4.2.11 Operation of the CONAXX 2

Detailed information please find in the enclosed instructions for use of the CONAXX 2.

4.3 Function of the PRS 500 C

4.3.1 Switching the PRS 500 C on and off

The PRS 500 C is switched on via the control panel of the generator. All system components are supplied with voltage via the generator. If a power box is included in the system, the power is supplied via the power box.

When the generator or Power Box is turned on at the power button, a self-test runs on the generator and control panel. After successful completion of the self-test, the parameters are displayed



NOTE

The mechanics for basic diagnostic X-ray systems PROGNOST C must be switched on!

4.3.2 Power Box



NOTE

→ **The power box is only used with certain generators (e.g., Venus-series).**

See "5021-0-0004 Technical Description" for a detailed description of the power box.

The power box ensures that the generator can be operated without a 230V connection and that the required 230V voltage for the components (power supply for the X-ray system and charging options for the DR panel) is separately fused and made available.

With the ON/OFF switch you could power-off the line of the generator (see picture).

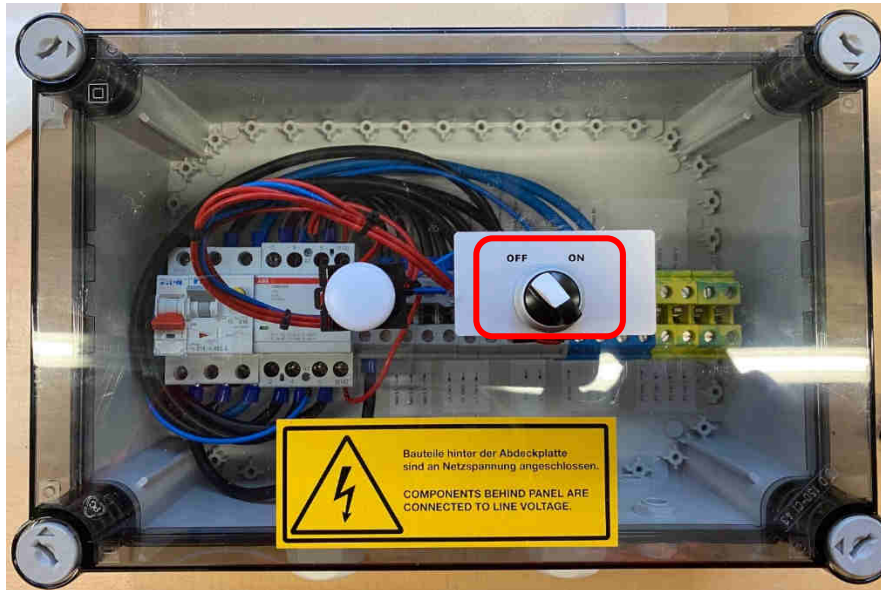

4.3.3 Dosimetric Calibration

The generator carries out a self-test of the selected dose-area measuring device (if present) when switching on and when switching the tubes in two-tube operation.

During this test, each dose area meter emits a defined number of test pulses which are determined by the generator and are compared with the stored test value. In the event of a deviation outside of the tolerance range (generator-dependent), a warning message is displayed, indicating that the measuring instrument has not been set correctly. In this case, please contact PROTEC customer service or a service authorized by PROTEC immediately.

4.4 Exposure automatic

If the PRS 500 C is operated with an exposure automatic the functionality can be checked like as follows:

Place a Phantom or any other weakening object (no lead) in the radiation way and position it above the measurement chamber field to be tested. Select the measurement chamber field to be checked and trigger the exposure. If this works properly, the measured value is displayed. Repeat this procedure for all existing measuring chamber fields. If an error message is displayed during this test, please contact PROTEC customer service or a service authorized by PROTEC immediately.

5 Safety and Maintenance



WARNING!

Caution, risk of electric shock!

Turn off the PRS 500 C before cleaning or disinfecting. This disconnects the PRS 500 C from the power source and avoids the risk of electric shock.

5.1 Introduction

In this chapter you will find information about safety and maintenance that are necessary to ensure the correct and reliable function of the device after installation.

5.2 Reusability

The PRS 500 C can be reused without any special preparation procedures.

However, it must be ensured that the surfaces in contact with patients are disinfected before the X-ray examination of each patient (see also chapter 4.1).

The PRS 500 C must no longer be used with patients if it shows signs of wear (e.g., metal abrasion, wear of insulations) or dangerous technical defects (e.g., torn cable, bent parts) or if the resulting image quality (e.g., artifacts in the image) is insufficient.

In this case, please contact PROTEC service department or a service company authorized by them immediately.

5.3 Cleaning and Disinfection



NOTE

Caution!

Possible material changes!



WARNING!

Make sure that no liquid enters the interior of the housing during cleaning and disinfection in order to prevent electrical short circuits and/or corrosion.



NOTE

For X-ray systems with RAPIXX implementation, please refer to the enclosed RAPIXX instructions for use and installation manual, chapter 8.2 for detailed information on cleaning and disinfections.

5.3.1 Cleaning

The cleaning of the PRS 500 C is very easy due to the very good quality surface coating. This is usually only done with a dry cloth.

Do not use corrosive, dissolving or abrasive cleaning agents, which could damage the device surfaces or the coating.

Clean the device surfaces and painted parts with a damp cloth and a mild to slightly alkaline cleaning solution (e.g., RBS® Neutral T) and wipe dry.

Chrome parts may only be wiped with a dry woollen cloth.

5.3.2 Disinfection

The disinfection must be performed in accordance with the current applicable legal requirements and guidelines corresponding for disinfection and explosion protection.

For disinfection of surfaces in contact with patients, we recommend commercially available medical rapid disinfection wipes (e.g. Dr. Schumacher Descosept Sensitive Wipes).

All mechanical parts of the PRS 500 C, including accessories, may only be cleaned with a wipe disinfection with suitable surface disinfectants (e.g. Melsept® SF, 15 min. application time at 2% concentration). The information provided by the disinfectant manufacturer on concentrations and application times must be observed.

**WARNING!**

No highly flammable disinfectants may be used! For safety reasons, spray disinfection must not be carried out, as the spray mist could penetrate the device and cause short circuits or corrosion.
If disinfectants are used that can form explosive gas mixtures, the device may only be switched on again when the gas mixtures have evaporated!

5.4 Inspection and maintenance

**WARNING!**

No maintenance or repair work may be performed while the PRS 500 C X-ray system is being used with a patient!
All maintenance and repair work may only be performed by personnel trained or authorized by PROTEC.

5.4.1 Daily monitoring prior and during the examination operation

See Instructions for use of all integral components.

Only original spare parts are to be used in situations requiring component replacement.

5.4.2 Regular monitoring

See Instructions for use of all integral components.

Only original spare parts are to be used in situations requiring component replacement.

5.4.3 Maintenance

The required maintenance must be carried out by PROTEC service department or a service company authorized by them in order to ensure the safe and reliable functionality of the device. The maintenance intervals depend on the frequency of use. The required specifications can be found in the corresponding Technical Description in chapter 3 *Maintenance and Safety Inspection*.

In the event that the planned maintenance is not carried out, PROTEC X-ray Systems GmbH assumes no liability whatsoever for damage to the user and third parties if damage results from inadequate or not carried out maintenance.

Prior to the examination operation, the user must satisfy himself that all appliances listed in the operating instructions and serving safety are in working order and that the product is ready for operation.

See the technical descriptions of the X-ray system and the associated system components.

Wear parts must be replaced with original components.

5.4.4 Warranty

**NOTE**

You will find the current warranty conditions in your order documents or in the price list valid at the time of purchase.

Repairs and spare parts in the event of improper use are also excluded.

Warranty work may only be carried out by trained specialists.

5.4.5 Product Service Life

The PRS 500 C is designed for a service life of 7 years when used in accordance with the specifications and regular maintenance by PROTEC service department or a service company authorized by them.

After the product has reached the end of its service life, further use is at your own risk.

5.4.6 Further Information

Detailed information to the individual chapters and for a safe operation, transport or storage can be found in the Technical Description of the PRS 500 C.

5.4.7 Applied Parts and Parts Considered as Applied Parts

Part	Definition (as applied part or parts which get handled like an application part but not defined as applied part)
Table top	Applied part
Cover / image receptor floor stand	Applied part
Housing parts PROGNOST C	Part, get handled like an application part
Patient extending handle (optional ; mounted at the image receptor floor stand)	Part, get handled like an application part

5.4.8 Disposal



The PRS 500 C contains various plastics, oils and heavy metal. When disposing exchange and spare parts, or if necessary, the entire system, the valid rules and regulations must be observed. Please contact your contractual partner or service company or commission a company specialized in disposing the respective components.

6 Power Supply



HINWEIS

The PRS 500 C requires the following power supply (see also table power supply generator):

Power supply	220-240 Vac
Power frequency	50-60 Hz
Input current	2,5 A

It is intended that the central power supply of the PRS 500 C is always connected to a supplied X-ray generator or power box using a hard-wired connection. Select a connection that consider the electrical specifications of the PRS 500 C like in the table.

There is a central power supply connection on the radiographic table to which the X-ray floor stand and the vertical X-ray system image receptor stand are also connected.

Type generator	VENUS 50R, 3-phase	VENUS 50R, 1-phase	VENUS 32R, 3-phase	VENUS 32R, 1-phase
Output Power	50kW	50kW	32kW	32kW
Power supply voltage	380V AC/400V AC	220V AC	380V AC / 400V AC	220V AC/230V AC
Phase	3PH-N-PE	1phase	3PH-N-PE	1phase
Power frequency	50/60Hz	50/60Hz	50/60 Hz	50/60 Hz
Electrical resistance per phase	0,15 Ω/0,17 Ω	0,5Ω	0,27 Ω/0,29 Ω	0,5Ω
Fuse	63A	16A	63A	16A

Table power supply generator Venus



WARNING!

To avoid the risk of an electric shock, this device may only be connected to a supply network with a protective earth conductor.

6.1 Electromagnetic Compatibility (EMC) according to EN 60601-1-2



CAUTION!

As a medical electrical device, the PRS 500 C is subject to special precautionary measures regarding EMC and must be installed and commissioned in accordance with the EMC information contained in the accompanying documents.



CAUTION!

Portable RF communication devices (radio devices) should not be used closer than 30 cm (12 inches) to the marked parts and cables of the PRS 500 C. Failure to observe can lead to a reduction in the performance characteristics of the device.



CAUTION!

The X-ray generator integrated into the radiographic system PRS 500C sends out electromagnetic waves during operation, which could cause interfere with or be interfered by other devices.

For EMC guidelines and manufacturers declaration for the generator according to EN 60601-1-2, see the separate instructions for use for the corresponding generator.

6.1.1 Guidelines and Manufacturer's Declaration – Electromagnetic Interference

The PRS 500 C is intended for use in the electromagnetic environment specified below. The customer or the operator of the radiographic system should assure that it is used in such an environment.

Emitted interference	Compliance	Electromagnetic Environment
RF emissions CISPR 11	Group 1	This radiographic system uses RF energy only for its internal function. Therefore, the RF emission is very low and unlikely to cause any interference in nearby electronic equipment.
RF emissions CISPR 11	Class A	This radiographic system is suitable for use in all establishments other than residential and those directly connected to the public utility system that also supplies buildings used for residential purposes, provided the following warning is heeded:
Harmonic emissions EN 61000-3-2	Class A	
Voltage fluctuation/ Flicker Emission EN 61000-3-3	Complies	Warning: This system is intended for use by healthcare professionals only. This is a Class A system according to CISPR 11. In a residential environment this system may cause radio interference in which case it may be necessary to take appropriate remedial action such as re-orientation, re-arrangement or shielding of the X-ray system or filtering of the site connection.

Immunity Test	EN 60601-1-2 Test level	Compliance level	Electromagnetic Environment - guidance
Electrostatic discharge (ESD) EN 61000-4-2	± 8 kV contact discharge ± 2kV, ± 4kV, ±, 8kV, ± 15 kV air discharge	± 8 kV contact discharge ± 2kV, ± 4kV, ±, 8kV, ± 15 kV air discharge	Floors should be wood, concrete or ceramic tile. If floors are covered with synthetic material, the relative humidity should be at least 30%.
Electrical fast Transient /burst EN 61000-4-4	± 2 kV for power supply lines ± 1 kV for input/output	± 2 kV for power supply lines ± 1 kV for input/output	The quality of the supply voltage should be that of a typical commercial or hospital environment.
Surge EN 61000-4-5	± 1 kV ± 2 kV	± 1 kV ± 2 kV	The quality of the supply voltage should be that of a typical commercial or hospital environment.
Power frequency (50/60 Hz) magnetic field	30 A/m 50/60 Hz	Not applicable!	Power frequency magnetic fields

EN 61000-4-8		No magnetic sensitive parts	should be at levels characteristic of a typical commercial or hospital environment.
Voltage dips, short interruptions and voltage variations on power supply input lines EN 61000-4-11	0% U_T for 0,5 period at 0°, 45°, 90°, 135°, 180°, 225°, 270°, and 315°	0% U_T for 0,5 period at 0°, 45°, 90°, 135°, 180°, 225°, 270°, and 315°	The quality of the supply voltage should be that of a typical commercial or hospital environment. If the operator of the radiographic system requires continued operation during power supply interruptions, it is recommended that the radiographic system be powered from an uninterruptible power supply or battery.
	0% U_T for 1 period 70% U_T for 25/30 periods 0% U_T for 250 periods	0% U_T for 1 period 70% U_T for 25/30 periods 0% U_T for 250/300 periods	
Conducted disturbances induced by RF fields EN 61000-4-6	3 V/m 1 kHz 80% AM 150 kHz to 80 MHz	3 V/m	
Radiated RF EN 61000-4-3	3 V/m 1kHz 80% AM 80 MHz to 2.7 GHz	3 V/m	see following table
NOTE: These guidelines may not apply in all situations. Electromagnetic propagation is affected by absorption and reflection from structure, objects and people.			

Test frequency MHz	Frequency band MHz	Service MHz	Modulation	Immunity test level V/m
385	380 - 390	TETRA 400	Pulse modulation: 18 Hz	27
450	430 – 470	GMRS 460, FRS 480	FM ±5 kHz Hub 1 kHz Sinus	28
710 745 780	704 – 787	LTE Band 13, 17	Pulse modulation: 217 Hz	9
810 870 930	800 – 960	GSM 800/900, TETRA 800, iDEN 820, CDMA 850, LTE Band 5	Pulse modulation: 18 Hz	28
1720 1845 1970	1700 - 1990	GSM 1800, CDMA 1900, GSM 1900, DECT, LTE Band 1, 3, 4, 25, UMTS	Pulse modulation: 217 Hz	28

2450	2400 – 2570	Bluetooth, WLAN, 802.11 b/g/n, RFID 2450, LTE Band 7	Pulse modulation: 217 Hz	28
5240 5500 5785	5100 - 5800	WLAN, 802.11 a/n	Pulse modulation: 217 Hz	9

7 Technical Data

7.1 Dimensions

Room plan version 1 (operation of the system):

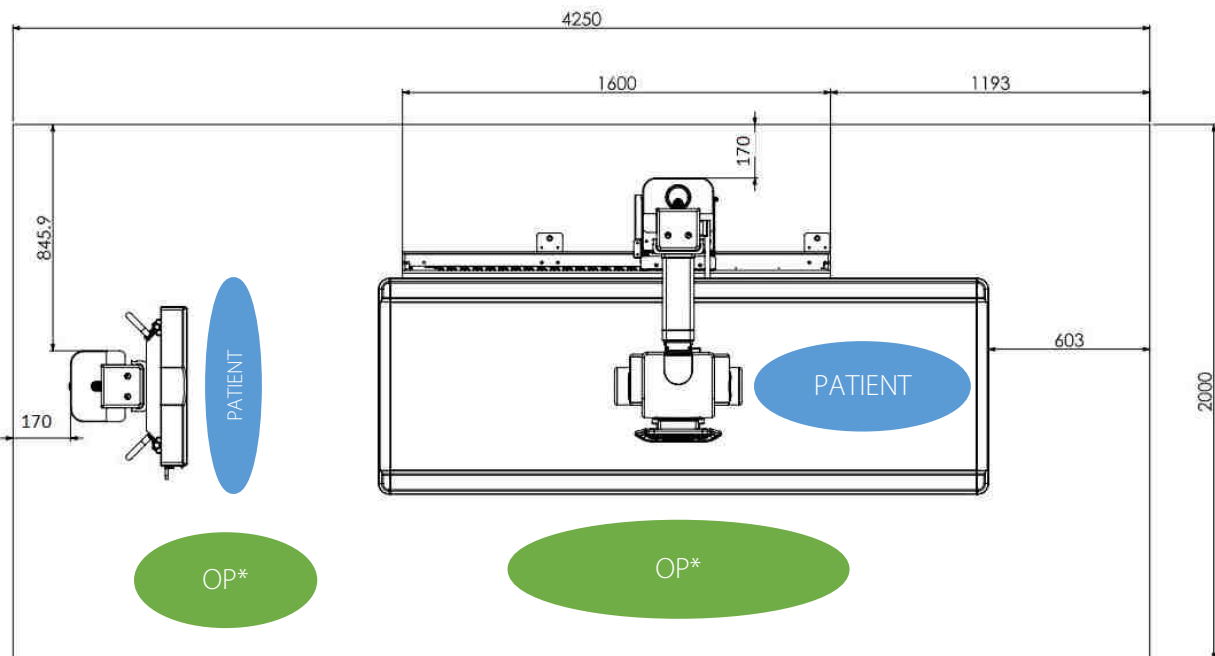
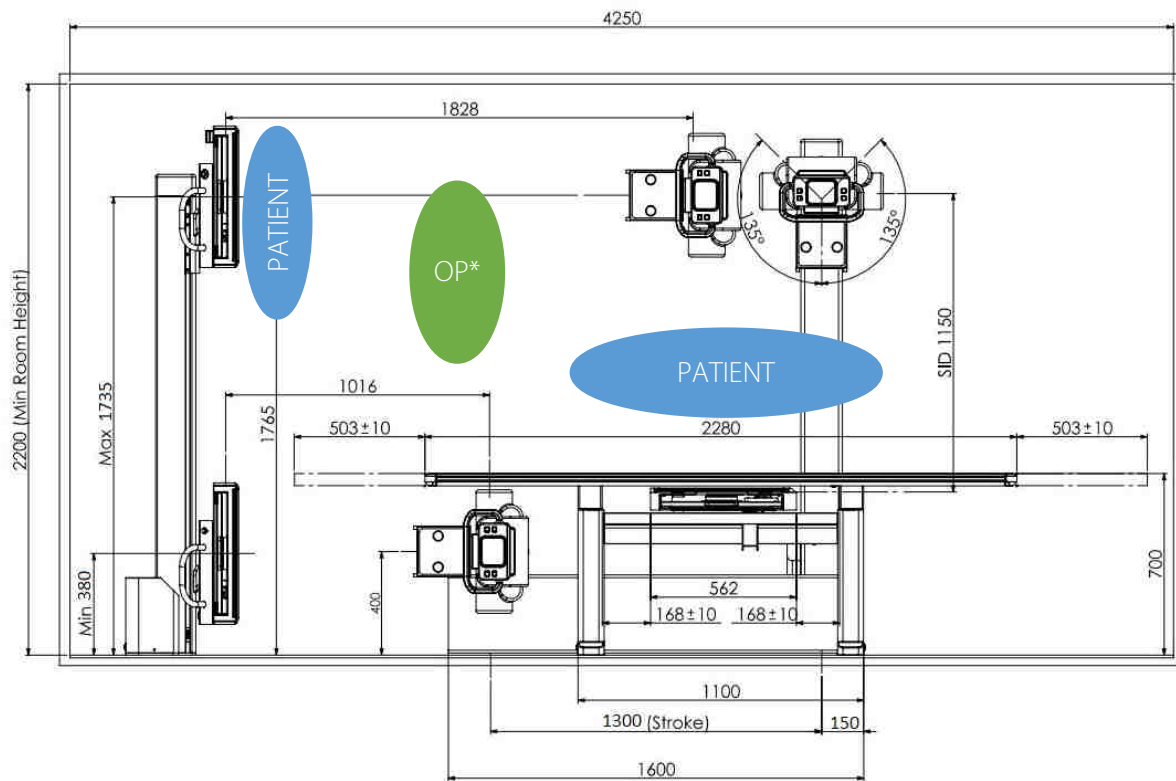

7.2 Patient positioning table

Table top dimension (L x B):	2280 mm x 800 mm, standard
Max. safe working load table	250 kg
Table top height:	700 mm
Table top movement, transvers (from the mid-position):	± 100 mm
Table top movement longitudinal (from the mid-position):	± 500 mm

The brakes of the table top are used electro-mechanic.

7.3 Bucky unit

Longitudinal travel:	280 mm
Table top - film-distance:	75 mm

The Bucky unit and the measure chambers are connected to the generator.

7.4 X-ray stem tube support, floor stand

Focal spot vertical travel - horizontal X-ray beam:	400 mm – 1765 mm
Focal spot vertical – film distance:	max. 1150 mm
Rotation X-ray tube assembly around horizontal support arm:	$\pm 135^\circ$
Tube stand longitudinal travel:	1300 mm

7.5 Vertical X-ray system image receptor stand

Column height:	1850 mm
Vertical shift film centre:	380 mm – 1735 mm

7.6 Attenuation Equivalent



WARNING!

The X-ray system PRS 500 C can be supplied with different options for the X-ray cassette holders. The device attenuation factor must be determined during the acceptance test. The variable components such as the X-ray tube, collimator, anti-scatter grid, measuring chamber automatic exposure, dose area product meter, etc. change the factor individually. The attenuation values of the components can be taken from the corresponding accompanying papers. The determination of the device attenuation factor must be carried out according to the specialist regulations. If the prescribed values cannot be met, this must be reported to PROTEC immediately. If additional components (positioning aids, etc.) are placed in the beam path, this will have a negative effect on the quality of the X-ray exposure.

The table top is defined as an application part.

The aluminium attenuation equivalent of the table top is typically 1.1 and < 1.2 Al mm for composite fibre, according to EN 60601-1-3. Tested at 100 kV with a first half-value layer thickness of 3, 7 mm Al and typically 0.6 mm Al und <0.8 mm Al according 21CFR § 1020-30 (n) with 100 kV and a first half-value layer thickness of 2.7 mm Al.

The vertical wall stand Bucky cover is defined as an application part.

The aluminium attenuation equivalent of the vertical wall stand cover is typically 0.5 and < 0.6 Al mm according to EN 60601-1-3. Tested at 100 kV with a first half-value layer thickness of 3.7 mm Al.

7.6.1 Protection Type and Protection Class

The PRS 500 C corresponds to protection class 1 and contains applied parts type B (according to EN 60601-1).

7.7 Automatic cut-off dose

7.7.1 Analogue system

The automatic cut-off dose is 2,5µGy.

7.7.2 Digital system

The automatic cut-off dose depends on the detector.

For RAPIXX systems, see the installation manual & instructions for use of the corresponding RAPIXX system (Chapter 3.2; 3.3)

7.8 Environmental

7.8.1 Environmental conditions during operation













Ambient Temperature	+ 10°C to 40°C
Relative humidity	30% to 75% (non-condensing)
Atmospheric pressure	700 hPa to 1060hPa



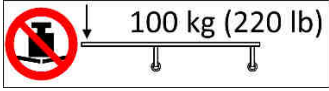

7.8.2 Environmental conditions for shipping and storage

Ambient Temperature	- 10°C to + 70°C
Relative humidity	10% to 95% (non-condensing)
Atmospheric pressure	500 hPa to 1060hPa

8 Description of symbols, labels and abbreviations

8.1 Symbols

	Air pressure limit
	Temperature limit
	Humidity limit
	Keep dry
	Fragile, handle with care
	This way up
	Attention, observe accompanying documents
	Refer to Instructions for use
CE 0297	CE-Marking
	Classification according to EN 60601-1 (type B applied part)
	Caution: pinch-/crushing hazard for hands and fingers
	Do not exceed the maximum indicated weight
	Do not exceed the maximum indicated weight
	Manufacturer
	Production date
MD	Medical Device
UDI	Unique Device Identification
SN	Serial number

	Order reference
	Disposal instructions; WEEE, Waste of Electrical and Electronic Equipment
 www.protec-med.com/download	This symbol indicates the need to consult the instructions for use. This is provided in an electronic format (eFU) on our website.
	Protective earthing

8.1.1 Generator; Tube; collimator and optional accessories

For additional information see the Technical Description and User Manual for the corresponding components.

8.2 Type label

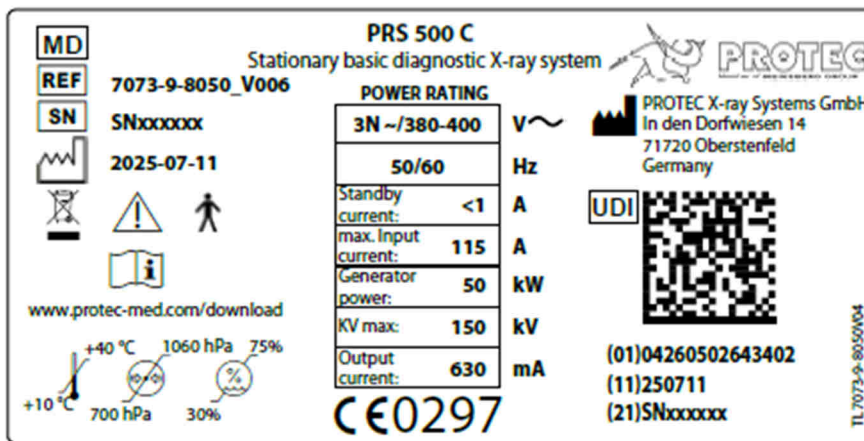

8.3 Labels

- Labels on the side of the table top:

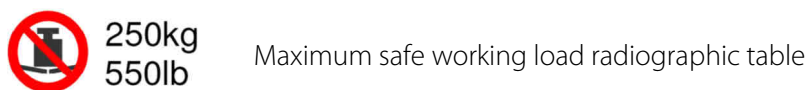
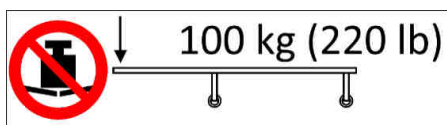

- Label on the table top and tube support, floor stand:



Caution: Watch out for possible crushing hazards to fingers or hands while moving the table top, table or X-ray unit.

- Label on the X-ray system tube support, floor stand and column X-ray system image receptor stand:



8.4 Position of the signs and the labels

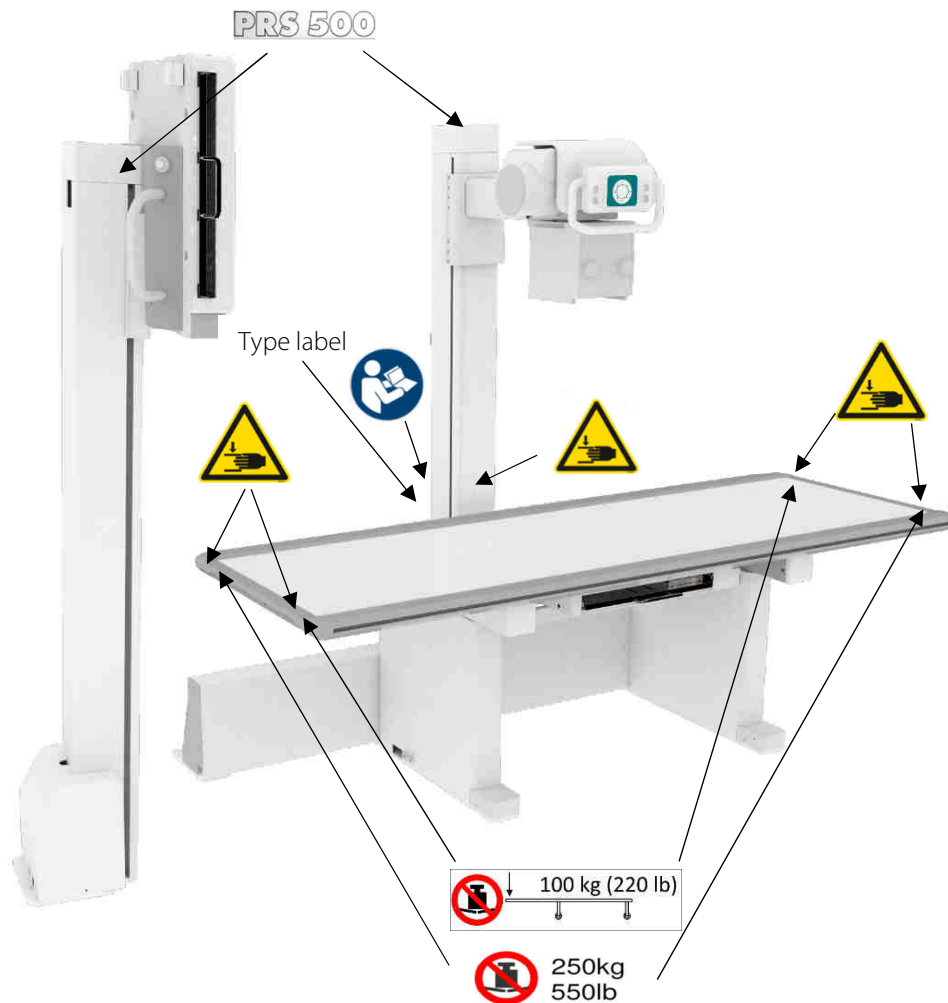

8.5 Abbreviations

mm	Millimetre
cm	Centimetre
lb	Pound
kg	Kilogram
°C	Degree -Celsius
hPa	Hectopascal
DIN	German Industry Standard
EN	European Standard
CE	CE-Mark
Hz	Hertz
ED	Duty cycle
A	Ampere
SN	Serial number