

PRS 500 F

Basic diagnostic X-ray system

Model/ID: 7067-9-8050_Vxxx

Basic UDI-DI: 426050264X006ZM

Instructions for use

Ident. Nr. 5067-0-8002



PRS 500 F in analogue base configuration

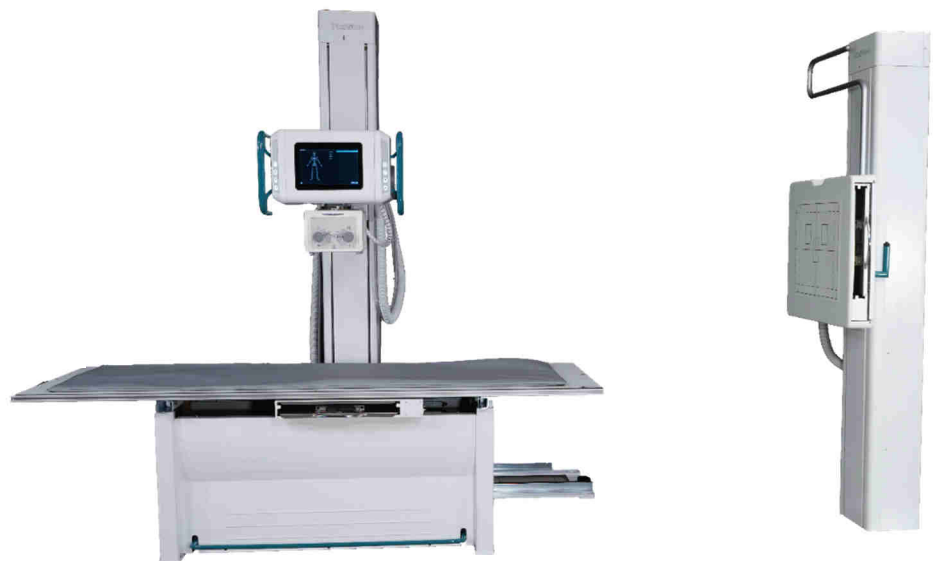

CE0297

**NOTE**

All sheets of this document contain proprietary and confidential information of PROTEC X-ray Systems GmbH and is intended for exclusive use by current PROTEC X-ray Systems GmbH customers. Copying, disclosure to others or other use is prohibited without the express written consent of PROTEC's law department. Knowledge of violations of these regulations must be reported immediately to PROTEC X-ray Systems GmbH.

© 2025 PROTEC X-ray Systems GmbH, Oberstenfeld

These accompanying documents were created and distributed by the documentation department.
Comments and questions about the documentation, please contact:

PROTEC X-ray Systems GmbH

In den Dorfwiesen 14 | 71720 Oberstenfeld

Germany

Phone: (+ 49) 7062 – 92 55 0

Fax: (+ 49) 7062 – 92 55 60

E-Mail: protec@protec-med.com

Internet: www.protec-med.com

Table of contents

	Page
Table of contents	3
Revision Status	6
General Notes	8
Mechanical – Electric Warning	8
Radiation Warning	8
1 Device Description	10
1.1 Introduction	10
1.2 Description.....	10
1.2.1 System Components	10
1.2.2 Hardware and Network System Requirements	10
1.2.3 Installation	11
1.2.3.1 Floor capacity	11
1.3 Performance Characteristics	11
1.3.1 Radiographic table	11
1.3.2 X-ray tube stand.....	12
1.3.3 Image receptor floor stand.....	12
1.4 Intended use.....	12
1.5 Clinical Benefit	12
1.6 Patient Target Group(s).....	12
1.7 Medical Conditions to be diagnosed	12
1.8 Indications and Contraindications	13
1.8.1 Indications	13
1.8.2 Contraindications.....	13
1.9 Intended User Group.....	13
1.10 Declaration of Conformity.....	13
2 Safety Instructions	14
2.1 General Safety Instructions.....	16
2.1.1 Requirements for Operation	16
2.1.2 Device Operation	16
2.1.2.1 Operating Type	16
2.1.3 Operating Personnel	16
2.1.4 Crushing and Collision Hazard	16
2.1.5 Explosion protection	16
2.1.6 Radiation Protection.....	17
2.1.7 Ventilation.....	17
2.1.8 Interaction with Other Devices.....	17
2.1.9 Electromagnetic Environment and Influencing of Devices	17
3 Control Elements and Displays	19
3.1 Main Switch of the X-ray system.....	19
3.2 Emergency Stop Switches of the X-ray system.....	20
3.2.1 Generator Emergency Stop Switch.....	20
3.3 Control elements and Display of PROGNOST F	20
3.4 Control elements and Display of PROGNOST SH.....	20
3.4.1 PROGNOST SH.....	20
3.4.2 PROGNOST SH TOUCH.....	21
3.4.3 Foot pedal.....	22
3.5 Control elements and Display of collimator	23
3.6 Control elements and Display of X-ray tube.....	23
3.7 Control elements and Display of X-ray generator.....	23
3.8 Control elements of Bucky, Grid entity.....	23
3.9 Control elements and Display of vertical X-ray system image receptor stand PROVERT.....	24
3.9.1 Vertical carriage	24

3.10	Control elements and device displays of RAPIXX system.....	24
3.11	Control elements and device displays of CONAXX 2.....	24
4	Handling / Operation.....	25
4.1	Requirements before and during Operation.....	25
4.2	Operation of the X-ray system.....	25
4.2.1	Operation at the X-ray system table.....	25
4.2.1.1	Releasing the tabletop brake and positioning the tabletop.....	25
4.2.1.2	Position of patients on the tabletop.....	25
4.2.1.3	Setting the X-ray unit to the centre of the Bucky/Grid entity.....	25
4.2.1.4	Inserting an image receptor into the cassette tray.....	26
4.2.1.5	Adjusting the focus-film distance (FFD).....	26
4.2.1.6	Adjusting the light resp. X-ray field.....	26
4.2.1.7	Exposure preparation / exposure release.....	27
4.2.1.8	On-table exposures.....	27
4.2.1.9	Exposures with the lateral detector holder (optional).....	27
4.2.2	Operation at X-ray system image receptor stand PROVERT.....	28
4.2.2.1	Adjustment of the X-ray unit to the mid of the Bucky/Grid entity of the image receptor stand (vertical centre beam).....	28
4.2.2.2	Adjustment of the source to image-receptor distance (SID).....	28
4.2.2.3	Adjustment of the light-/ radiation field.....	28
4.2.2.4	Exposure preparation/ release.....	29
4.3	Operation X-ray system table PROGNOST F.....	29
4.4	Operation collimator.....	29
4.5	Operation X-ray tube.....	29
4.6	Operation X-ray generator.....	29
4.7	Operation Bucky, Grid entity.....	29
4.8	Operation vertical X-ray system image receptor stand PROVERT.....	29
4.9	Operation RAPIXX system.....	29
4.10	Operation Software.....	29
4.11	Function of the PRS 500 F.....	29
4.11.1	Switching the PRS 500 F on and off.....	29
4.12	Automatic Exposure Control.....	30
5	Safety and Maintenance.....	31
5.1	Introduction.....	31
5.2	Reusability.....	31
5.3	Cleaning and Disinfection.....	31
5.3.1	Cleaning.....	31
5.3.2	Disinfection.....	31
5.4	Inspection and maintenance.....	32
5.4.1	Daily Monitoring before and during the Examination operation.....	32
5.4.2	Regular Monitoring.....	32
5.4.3	Maintenance.....	32
5.4.4	Warranty.....	32
5.4.5	Product Service Life.....	33
5.4.6	Further Information.....	33
5.4.7	Applied Parts and parts which get handled like an application part.....	33
5.4.8	Disposal.....	33
6	Power Supply.....	34
6.1	Electromagnetic Compatibility (EMC) after EN 60601-1-2.....	34
6.1.1	Guidelines and Manufacturer's Declaration – Electromagnetic interference.....	35
7	Technical Data.....	38
7.1	Dimensions.....	38
7.2	X-ray system table PROGNOST F.....	40
7.3	Bucky, Grid entity.....	40
7.4	X-ray Tube Support Stand.....	41
7.5	Image Receptor Stand.....	42
7.6	Attenuation Equivalent.....	42

7.6.1	Protection Art and Protection Class.....	42
7.7	Automatic Cut-off Dose.....	42
7.7.1	Analogue System	42
7.7.2	Digital System.....	42
7.7.3	Digital System.....	42
7.8	Environmental Conditions	42
7.8.1	Environmental conditions during operation	42
7.8.2	Environmental Conditions for Shipping and Storage	43
8	Description of symbols, labels and abbreviations	44
8.1	Symbols	44
8.2	Identification label.....	46
8.3	Labels	46
8.4	Position symbols and labels.....	48
8.5	Abbreviations	49

**NOTE**

The information contained in this document conforms to the configuration of the equipment as of the date of manufacture. Revisions to the equipment subsequent to the date of manufacture will be addressed in service updates distributed to the PROTEC Technical Service Organization.

Revision Status

Revision	Date	Updated pages	Comments	Author
1.0	2019-05-14	all	New created, replaces document 5087-0-0002	-
2.0	2019-07-31	Chap. 1.2, 1.7, 6.1.1, 8.1, 8.2, 8.4	GMDN terms updated Changed optional accessories and images dimension EMC tables removed Symbols added Identification label updated	-
3.0	2020-06-19	Chap. 1.2.2.1, 1.3.2, 3.2, 7.4	Telescopic arm added	-
4.0	2020-08-11	Front page, Chap. 5.3.3	Maintenance updated	-
5.0	2020-11-12	Chap. 1.2.1; Chap.6; Chap. 3.1.1; Chap. 3.1.2; Chap. 4.1.1.8	New generators, Rotatable X-ray column added	-
6.0	2022-01-19	Front page, Chap. 3.2.3; Chap. 1.2.2; Chap. 1.2.2.1; Chap. 1.3.2; Chap. 7.1	Basis UDI-DI new; Note Rotation; Note Installation new; total weight changed; ceiling height changed; Traverse paths PROGNOST SH changed vertically; translation cpl. revised	ML
6.1	2022-11-28	Chap. 1.2.1; Chap. 4.2.1.2; Chap. 4.2.21; several	Optional Accessories actualised; adding warning and laser line; replacing "cassette" against "image receptor"	DP
6.2	2022-02-02	Chap. 1.2.1	Optional Accessories actualised	ML
6.3	2023-04-12	Chap. 1.3.2, 3.4.1, 3.4.2, 8.1	Electrical release for rotation of X-ray tube stand added	TB
6.4	2023-07-12	List 7.4; Chap. 8.2; page 13	Traveling distance long floor rails new; Typelabel; FB-04-07A4.3	ML

6.5	2024-04-12	Chap. 4.2.1.3, 4.2.2.1, 4.2.1.9, 7.4, 4.11.2	Figure with new symbol inserted on clamping device for centering the Bucky/Grid, caution and remark added to the column rotation, traveling distance for angulation around horizontal tube column added, dosimetric calibration removed.	TB
		Chap. 4.2.1.1	Releasing tabletop brake added	DP
6.6	2024-12-04	Chap. 7.1; 7.5	Figure changed; Vertical shift film center changed	ML
6.7	2025-07-18	all	First edition "PROTEC X-ray Systems GmbH"	DP
6.8	2025-08-13	All	Checked Notes, Cautions and Warnings MDR content	ML

General Notes



WARNING!

In order to maintain the set and tested requirements of the 60601 series of standards, the ME system must not be modified during its actual operating life.

Mechanical – Electric Warning



WARNING!

All of the movable assemblies and parts of this equipment should be operated with care and routinely inspected in accordance with the manufacturer's recommendations contained in the equipment Accompanying Documents. Maintenance and service is only to be performed by Customers authorized by PROTEC X-ray Systems GmbH.

Live electrical terminals are deadly.

Do not remove flexible high-tension cables from X-ray tube housing or high-tension generator and/or access covers from X-ray generator.

For all components of the equipment protective earthing means must be provided in compliance with the national regulations.

Failure to comply with the foregoing may result in serious or fatal bodily injuries to the operator or those in the area.

Radiation Warning



WARNING!

In these accompanying documents, a system or a component for such a system is documented, which is used for the intended generation of X-rays in medical diagnostics.

X-rays are ionizing radiation that can cause damage to living organisms (e.g. cancer or mutations).

X-rays represent a potential risk for patients and employees. Therefore, the application of X-rays with a given medical issue, must aim at the minimization of radiation exposure for both groups of people.

The group of people responsible for the application must have the necessary specialist knowledge in accordance with the ordinances and guidelines and apply the procedures for the safe operation of such systems.

The national regulations must also be observed during planning and installation.

The X-rays are created in the X-ray tube by strong braking of previously accelerated electrons, which emit energy in the form of electromagnetic waves. The intensity depends on the set parameters voltage (kV), current (mA) and time (s) on the X-ray generator. The X-rays are only emitted at a radiation exit window of the tube and are limited by the collimator mounted directly below.

The X-ray components from PROTEC used are only devices for the human medical diagnostic area, which can be set up to a maximum of 150 kV. Further information can be found in the technical data inside the instructions for use for the generators, X-ray tubes and collimators.

To the User

**NOTE**

The user of these accompanying documents is required to carefully read through and carefully consider the instructions, warnings and cautions contained therein before starting operation.

Even if you have already operated similar systems, changes in the design, production and functional routine of the system described here may have been made, which have a significant influence on the operation.

Although the product was subject to a risk analysis and the design corresponds to the current state of the art, residual risks remain in clinical use. These are displayed in the following Instructions for use by application limits, contraindications, warnings and precautions.

Assembly and service works on the system described here must be carried out by authorised and qualified personnel from PROTEC X-ray Systems GmbH. Assembly personnel and other persons who are not employees of the technical service department of PROTEC X-ray Systems GmbH are requested to contact the local branch of PROTEC X-ray Systems GmbH before assembly or service work is started. For assembly and service works, it is necessary to use the "Technical Description" of the product and to observe the points it contains.

**NOTE**

The use of the product with add-on or accessory parts not authorized by PROTEC or other unapproved components is not permitted.

1 Device Description

1.1 Introduction

The instructions for use describe the performance characteristics and operation required for efficient and effective use of the PRS 500 F.

Before working with the PRS 500 F, the complete instructions for use must be read, especially the Safety Instructions and the chapter Handling.

1.2 Description

The PRS 500 F series radiography system is a complete and powerful easy-to-use bucky workplace featuring high performance for the operator and a pleasant atmosphere for patients. The complete system delivers excellent image acquisition quality and is ideal for all types of X-ray examinations in radiology centres, clinics and hospitals – regardless of whether analogue or digital imaging methods are used.

1.2.1 System Components

The PROTEC X-ray system PRS 500 F consists of the following components:

- Stationary patient positioning table with floating tabletop
- X-ray tube support stand with control arm
- X-ray cassette holder (Bucky or Grid entity)
- Image receptor stand
- X-ray generator
- X-ray tube assembly with cover
- Anti-scatter grid
- Collimator

Optional Components

- Measuring chamber (ionisation or solid state),
- Dose area product meter
- Various DR systems (RAPIXX series, consisting of DR detector, Interface Box and CONAXX software)

Optional Accessories

The following optional accessories are available for the PRS 500 F X-ray system:

- Patient extending handle*
- Compression band
- Mattress 190 cm x 60 cm x 1.5 cm
- Ball knob grab handle
- Handgrip long
- Lateral detector holder (only in connection with the rotatable X-ray column PROGNOST SH)*
- Bumper profile
- Ceiling bracket cabling (2m/4m)
- Wall bracket cabling (2m/4m)

*Accessories with medical purpose

Accessories that can influence the EMC conditions

- Network cable (note the max. cable length in the component documentation)
- RAPIXX data connection cable (note the max. cable length in the component documentation)
- WLAN router or access points (only use devices approved by PROTEC).

1.2.2 Hardware and Network System Requirements

If it is an X-ray system with optional system components for digital use, it should be ensured that the country-specific requirements for data protection and IT security are met.

The system requirements for the optional system components (RAPIXX series) can be found in the current document supplied, "EN_5330-0-0026_CONAXX2_System requirements".

1.2.3 Installation



NOTE

The installation of the PRS 500 F must be performed by PROTEC service department or a service company authorized by them.

This X-ray system PRS 500 F must be installed in a shielded X-ray room that complies with the national regulations on radiation protection.

The room intended for the installation of the X-ray system must be prepared. This may need to include changes to the routing of electrical connections to a central distribution cabinet. The electrical and structural design of the room intended for the generator must comply with national regulations (electrical and floor weight load).

For more information, please see separate "Installation manual" PRS 500 F.

Contact information of persons qualified to perform installations are available upon request at:

PROTEC X-ray Systems GmbH
In den Dorfwiesen 14 | 71720 Oberstenfeld
Telephone: +49 (0) 7062 – 92 55 0
Fax: +49 (0) 7062 – 92 55 60
E-Mail: protec@protec-med.com
Internet: www.protec-med.com

1.2.3.1 Floor capacity



NOTE

The X-ray system is primarily made of metal pieces. This has a corresponding effect in the weight of the device.

The X-ray system **PRS 500 F has a weight of 823 kg** (incl. Generator),
Every technician is obliged to check the corresponding floor load before each installation. Raised floors and hollow floors must also be considered.

1.3 Performance Characteristics

1.3.1 Radiographic table

- Floating tabletop
- Tabletop colour: white.
- Motor-operated tabletop brake for effortless patient positioning.
- Low optimised distance between the tabletop surface and the image receptor surface.
- Large adjustment range of the tabletop for positioning the patient.
- High reliability
- Side profile rails on the long sides of the tabletop for attaching accessories.
- Prepared for the installation of an X-ray cassette holder (Bucky or Grid entity) with anti-scatter grid and a measuring chamber for operation with an automatic exposure control.
- Variable cassette / detector sizes can be used. Formats from 13 cm x 18 cm (5" x 7") to 43 cm x 43 cm (17" x 17"), depending on analogue or digital use.
- Suitable for a Bucky or a Grid entity (analogue or digital)

1.3.2 X-ray tube stand

- Ceiling-free column stand intended for use within rooms with a ceiling height of at least 2.35 m / standard and 2.40 m / with rotation X-ray column.
- Wide range of application.
- Small wall distance allows good use of space.
- Control elements on the command arm are handily placed.
- Reproducible position of the X-ray assembly when rotating around the support arm axis through angle indicator.
- Vertical travel range, focus height from 29.7 cm to 189.6 cm with horizontal beam path
- Electromagnetic brakes for the longitudinal movement of the column stand, the vertical movement of the support arm, for the rotation of the X-ray tube assembly around the support arm axis +/-180° with additional 90° detents as well as for the transversal movement of the support arm +230 mm (optional).
- Linear drive for electrical unlocking to rotate the X-ray tube stand around the X-ray arm axis with additional 90° detents (optional).
- Safety coupling for the automatic centring of the X-ray tube assembly with the X-ray cassette holder (Bucky or Grid entity).

1.3.3 Image receptor floor stand

- Space-saving with a small footprint
- Wall and floor mounting or just floor mounting
- Left or right cassette loading
- Variable cassette / detector sizes can be used. Formats from 13 cm x 18 cm (5" x 7") to 43 cm x 43 cm (17" x 17"), depending on analogue or digital use.
- Suitable for a Bucky or a Grid entity (analogue or digital).

1.4 Intended use

The basic diagnostic X-ray systems of the PRS 500 series are intended for various routine applications in planar X-ray imaging in human medicine.

They are stationary systems that can be used both for analogue and digital imaging.

1.5 Clinical Benefit

The clinical benefit of using diagnostic X-ray systems in human medicine is the generation of conventional two-dimensional X-ray images for creation or specification of findings as a basis for treatment decisions.

1.6 Patient Target Group(s)

The intended patient group includes all people for whom a justifying indication for a medical X-ray has been given by a physician with the necessary expertise in radiation protection.

There are no general or fundamental restrictions on the patient group regarding age, gender, origin and patient condition.

1.7 Medical Conditions to be diagnosed

A complete list of medical conditions that can be diagnosed is impossible for conventional radiography, because the spectrum of conventional X-rays is very diverse and can vary in the course of medical-technical progress.

Examples for medical conditions to be diagnosed:

- For the diagnosis of a bone fracture or bony injuries of the skeletal system or pathological changes of hard tissues.
- For monitoring of correct reduction of bone fractures
- For the diagnosis of joint dislocations and ligament ruptures of the musculoskeletal system.
- For the diagnosis of degenerative, inflammatory, traumatic and tumorous diseases and changes of the musculoskeletal system.
- For diagnostic of malformations and malalignments of the skeletal system.

- For the diagnosis of thoracic and pulmonary symptoms (thorax exposures)
- For the diagnosis of sclerotherapy.
- For the diagnosis of inflammatory and expansive processes of the mucosa, cranial bones and paranasal extension.
- For the diagnosis of the abdomen (e.g. acute abdomen, plain abdominal radiography, urethrogram, cystogram).

1.8 Indications and Contraindications

1.8.1 Indications

According to §83 of the German radiation protection law (StrlSchG), an X-ray examination is only justified if the patients benefit from X-ray diagnostics outweighs the radiation risk. The examination method, means the conventional X-ray with the PRS 500 System, must be suitable to answer the diagnostic question and no other more suitable alternative method is available.

Accordingly, it is also described by the International Atomic Energy Agency (IAEA) in the document Radiation Protection and Safety of Radiation Sources: International Basic Safety Standards (Requirement 37: Justification of medical exposures). It also refers to the need to consider national or international guidelines for the justification of a medical exposure.



NOTE

Even if, according to the justifying indication, the benefit predominates the radiation risk, it must not be disregarded that there are residual risks due to ionising radiation and that undesirable side effects may occur. Ionising radiation (X-radiation) can damage the genome and, in the long term, lead to cancer and mutations and thus damage the human body.

1.8.2 Contraindications

There are no absolute contraindications for conventional X-rays. But it is not allowed to make any exposures on humans when they are not medically indicated (see justification of medical exposures). For pregnant women and children it is important to consider if the exposure is really necessary. It should be avoided if possible.

1.9 Intended User Group

The X-ray systems of the PRS 500 series are intended exclusively for use by professional users who are trained in the operation of diagnostic X-ray systems in accordance with the respective national regulations and who are familiar with the proper handling, use and operation and also have been instructed in the permitted conjunction with other medical products, objects and accessories. Appropriate users can be, for example: X-ray technicians, X-ray assistants, medical technical X-ray assistants, surgeons, casualty surgeons, orthopaedists and other trained medical personnel.

1.10 Declaration of Conformity

CE0297

This product is in conformity with the requirements of the European Community Medical Device Directive 93/42/EEC from 06/14/1993 including all current revision standards.

The declaration of conformity is available directly from PROTEC:

PROTEC X-ray Systems GmbH
In den Dorfwiesen 14 | 71720 Oberstenfeld
Telephone: +49 (0) 7062 – 92 55 0
Fax: +49 (0) 7062 – 92 55 60
E-Mail: protec@protec-med.com
Internet: www.protec-med.com

2 Safety Instructions

**NOTE**

Contains information that must be observed during operation.

xxx

**CAUTION!**

Contains information which, if not observed, can cause property damage.

xxx

**WARNING!**

Contains information which, if not followed, can cause personal injury.

xxx

**WARNING!**

Warning of radioactive substances or ionizing radiation. Contains information which, if not observed, can cause personal injury.

xxx

Settings and calibrations that are not described in these instructions for use must be carried out using the technical description of the device by PROTEC service department or a service company authorized by them.

**NOTE**

All instructions supplied with the X-ray system must be observed and the safety instructions contained therein must be carefully read and adhered to.

**NOTE**

After the initial installation, the commissioning must be recorded with the PROTEC acceptance protocol FB-04-07A4.3.

**NOTE**

In the case of a digital system, the instructions for CONAXX and RAPIXX must be observed and the safety instructions contained therein must be carefully read and adhered to.

**NOTE**

The X-ray system may only be commissioned if all safety measures for operator protection have been met and checked. These protective measures can include door contact, designated area, dosimeter, protective clothing, etc.

**CAUTION!**

The instructions for use contain all the information relevant to safety in order to generally put the X-ray system into operation. The device may only be operated by appropriately trained and trained personnel. In this context, operation is ensured by clear symbols on the control elements. All further information and instructions can be found on the supplied data carrier (USB, CD or DVD). This information applies in its entirety as an appendix to these instructions for use and must be observed

**NOTE**

All control elements are marked with clear symbols on the control console and on the swivel arm or the image receptor stand, which are described again in detail in the corresponding instructions for use. The legal requirements regarding the building regulations for an X-ray area must be met. The X-ray system must be tested in accordance with the regulations in force in the country of installation and approved by the appropriate body.

**CAUTION!**

If the wrong SID is set for an exposure, it can have a damaging effect on the patient. The inverse square law applies. Halving the distance leads to a radiation dose that is four times higher.

**WARNING!**

X-rays may not be performed on persons without a medical justifying indication. In the case of pregnant women and children, it must be carefully considered whether an exposure is necessary. It should be avoided if possible.

2.1 General Safety Instructions

2.1.1 Requirements for Operation



WARNING!

The PRS 500 F is a protection class I device (according to EN 60601-1). To avoid the risk of an electric shock, this device may only be connected to a supply network with a protective earthing conductor. The power supply for the PRS 500 F of the X-ray system is exclusively made by direct connection to the X-ray generator or the Power Box and is permanently connected there. The X-ray generator or the Power Box must have at least 2 connections for 230V 50/60Hz. The X-ray generator of the X-ray system is connected to the supply network (see technical description of the X-ray generator). To reduce the risk of electric shock, the system must be connected to a supply network with protective earthing. The system does not have an on/off switch. It is switched on or off directly by switching on the X-ray generator or by the switch on the Power Box. In order to separate any electrical voltage from the X-ray system, the connected X-ray generator or the Power Box must be switched off.

2.1.2 Device Operation

In case of a malfunction, do not use the PRS 500 F anymore and notify PROTEC service department or a service company authorized by them.

2.1.2.1 Operating Type

The PRS 500 F is not intended for continuous operation. The separate maximum operating times must be taken from the individual components. Duty Cycle: S3 15% - maximum continuous operation of 1,5 minutes.

2.1.3 Operating Personnel



NOTE

Only trained and authorized personnel are allowed to work on the PRS 500 F.



NOTE

The operating personnel must be familiar with all warning signs attached to the PRS 500 F. They are used for your own safety and that of others and ensure proper operation.

2.1.4 Crushing and Collision Hazard



WARNING!

It must be ensured that when operating the moving parts of PRS 500 F, no persons or objects are in the obvious danger area of the device. If not observed, it can result in personal injury or damage to the PRS 500 F or other objects.

2.1.5 Explosion protection

These PRS 500 F is not designated for use within areas with explosive hazards.

2.1.6 Radiation Protection

X-rays can pose a risk to patients and other people if the regulations for the operation of such systems are not observed.

For this reason, the principles of radiation protection must have top priority and must be strictly adhered to:

- **Keeping distance from the radiation source**

The dosage is reduced as a factor of the square of the distance from a (dot shaped) radiation source. Double the distance $\frac{1}{4}$ dose, triple the distance $\frac{1}{9}$ dose, etc.

The dose decreases with the square of the distance from a (point) radiation source, i.e. double distance $\frac{1}{4}$ dose, triple distance $\frac{1}{9}$ dose, etc.

- **Keeping exposure time as short as possible**

The longer the exposure time, the higher the dose, i.e. halving the exposure time leads to halving the dose, etc.

- **Utilize shielding and protective clothing**

The protection value increases exponentially with the thickness of the shielding, i.e. 2 half-value layers weaken a (homogeneous) radiation to $\frac{1}{4}$, 3 half-value layers to $\frac{1}{8}$ and 10 half-value layers to less than $\frac{1}{1000}$ of the initial value.

- **Do not reach into the direct X-Ray beam**

The dose in the non-attenuated direct beam is about 100 times greater than that in the area of scattered radiation.

- **Utilize personal dosimeters**

When working with radiation, dosimeters should be used for monitoring that are appropriate for the activity.

The X-Ray exposures are principally triggered from behind a protective wall. When taking exposures near the genital organs use the maximum available protection (e.g. gonad protectors or lead covers). Persons who have to be in the vicinity of the patient must wear protective clothing (e.g. lead aprons). The same applies to maintenance and repair work.

2.1.7 Ventilation

It must be ensured that the air exchange from the X-Ray generator in the system is not hindered. The ambient air temperature must not exceed 40 °C.

2.1.8 Interaction with Other Devices

Interactions with other devices are not known.

2.1.9 Electromagnetic Environment and Influencing of Devices



CAUTION!

The use of other accessories, other converters and other cables than those specified by PROTEC or provided in the documentation of the component manufacturer can result in increased electromagnetic interference or reduced electromagnetic immunity of the device and lead to defective operation.



CAUTION!

The use of the PRS 500 F immediately next to other devices or with other devices in a stacked form should be avoided, as this could result in defective operation. If use in the manner described above is nevertheless necessary, the PRS 500 F and the other devices should be observed to ensure that they are working properly.

**NOTE**

The properties of this device, determined by emissions, allow its use in industrial areas and in hospitals (CISPR 11, class A). When used in residential areas (for which class B is usually required by CISPR 11), this device may not provide adequate protection for radio services. The user may need to take remedial measures such as relocating or realigning the device.

The PRS 500 F is intended for use in an environment in professional health care facilities (e.g. clinics, surgery centres, physiology practices ...)

3 Control Elements and Displays

3.1 Main Switch of the X-ray system

The PRS 500 F is switched on and off via a mini console (e.g. of the Venus-32/50-R, see Fig. 3.1a), a normal control console (e.g. of the Venus-32/50-R, see Fig. 3.1b) of the X-ray generator or via the switch on the Power Box (see Fig. 3.1c).

The illustrations of the mini and operating console may differ depending on the system configuration. However, the symbols for switching on or off are identical.

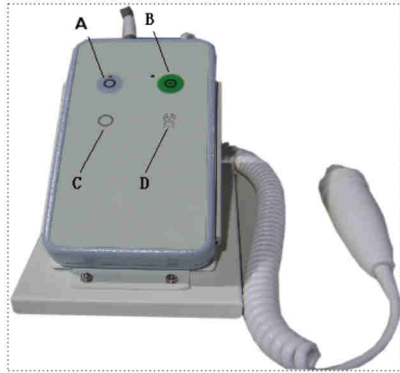

Fig. 3.1a Mini console Venus-32/50-R

A	Switching off the PRS 500 F
B	Switching on the PRS 500 F
C	Ready for exposure
D	Radiation indicator

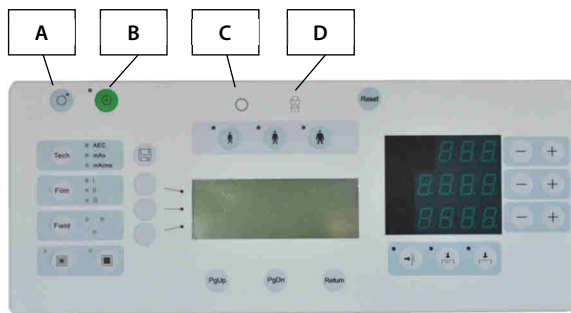

Fig. 3.1b Control console Venus-32/50-R

A	Switching off the PRS 500 F
B	Switching on the PRS 500 F
C	Ready for exposure
D	Radiation indicator



Fig. 3.1c Power Box Switch

OFF	Switching off the PRS 500 F
ON	Switching on the PRS 500 F

3.2 Emergency Stop Switches of the X-ray system

The PRS 500 F has the following emergency stop switches, which can be used to bring the device to an immediate standstill and disconnect it from the power supply.

3.2.1 Generator Emergency Stop Switch

For the switch position of the corresponding X-ray generator, please refer to the enclosed PRS 500 F instructions for use.

3.3 Control elements and Display of PROGNOST F

Detailed information please find in the accompanying Instructions for use of the PROGNOST F.

3.4 Control elements and Display of PROGNOST SH

3.4.1 PROGNOST SH

- 1 Angle indicator for adjusting the X-ray assembly
- 2 Brake release for horizontal movement of the X-ray floor stand
- 3 Brake release for rotational movement of the X-ray unit around the horizontal support arm axis
- 4 Brake release for vertical movement of X-ray tube arm and horizontal movement of X-ray floor stand
- 5 Brake release for vertical movement of X-ray tube arm and horizontal movement of X-ray floor stand
- 6 Brake release for movement of X-ray tube assembly around the horizontal support arm axis
- 7 Brake release for vertical movement of X-ray tube arm
- 8 Option: Brake release for transversal movement of X-ray tube arm (+230mm)
- 9 Option: Status-LED orange (if LED is on: X-ray tube arm is not engaged)
- 10 Option: Status-LED red (if LED on: X-ray floor stand is not engaged)
- 11 Optional: Electrical release for rotating the X-ray floor stand by $\pm 180^\circ$



WARNING!

If the red LED on the right membrane keypad lights up, the X-ray tube carrier is not engaged! In this state no x-rays may be taken. The X-ray tube carrier must first engage in one of the positions (0 / $\pm 90^\circ$ / $\pm 180^\circ$)!

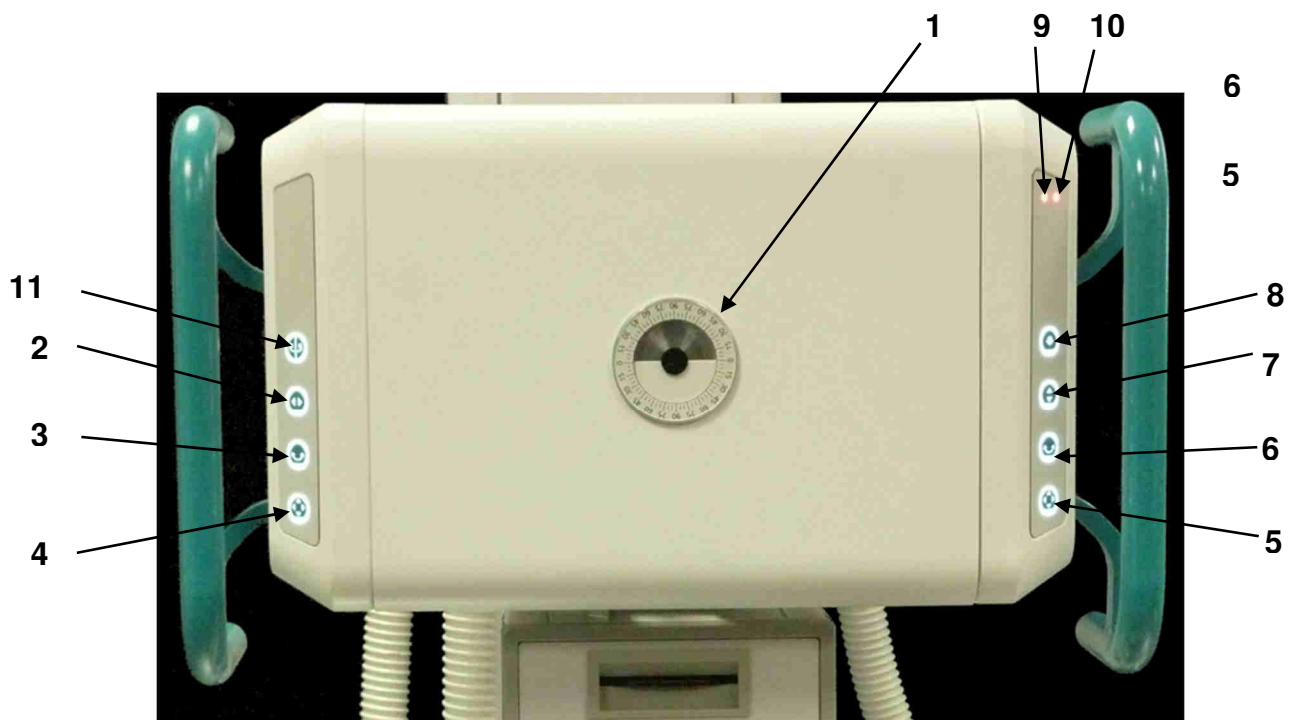

Operation is performed from the front (operating side) of the X-ray head.

In the case of encompassed handles, the electromagnetic locking of one or more movements can be released by pressing the keys on the operating unit with the thumb, and the tube head can be moved to the desired position.

3.4.2 PROGNOST SH TOUCH

- 1 Touchdisplay of X-ray tube assembly
- 2 Brake release for horizontal movement of X-ray floor stand
- 3 Brake release for movement of X-ray tube assembly around the horizontal support arm axis
- 4 Brake release for vertical movement of X-ray tube arm and horizontal movement of X-ray floor stand
- 5 Brake release for vertical movement of X-ray tube arm and horizontal movement of X-ray floor stand
- 6 Brake release for movement of X-ray tube assembly around the horizontal support arm axis
- 7 Brake release for vertical movement of X-ray tube arm
- 8 Option: Brake release for transversal movement of X-ray tube arm (+230mm)
- 9 Option: Status-LED orange (if LED is on: X-ray tube arm is not engaged)
- 10 Option: Status-LED red (if LED on: X-ray floor stand is not engaged)
- 11 Optional: Electrical release for rotating the X-ray floor stand by $\pm 180^\circ$



WARNING!

If the red LED on the right membrane keypad lights up, the X-ray tube carrier is not engaged! In this state no x-rays may be taken. The X-ray tube carrier must first engage in one of the positions (0 / $\pm 90^\circ$ / $\pm 180^\circ$)!

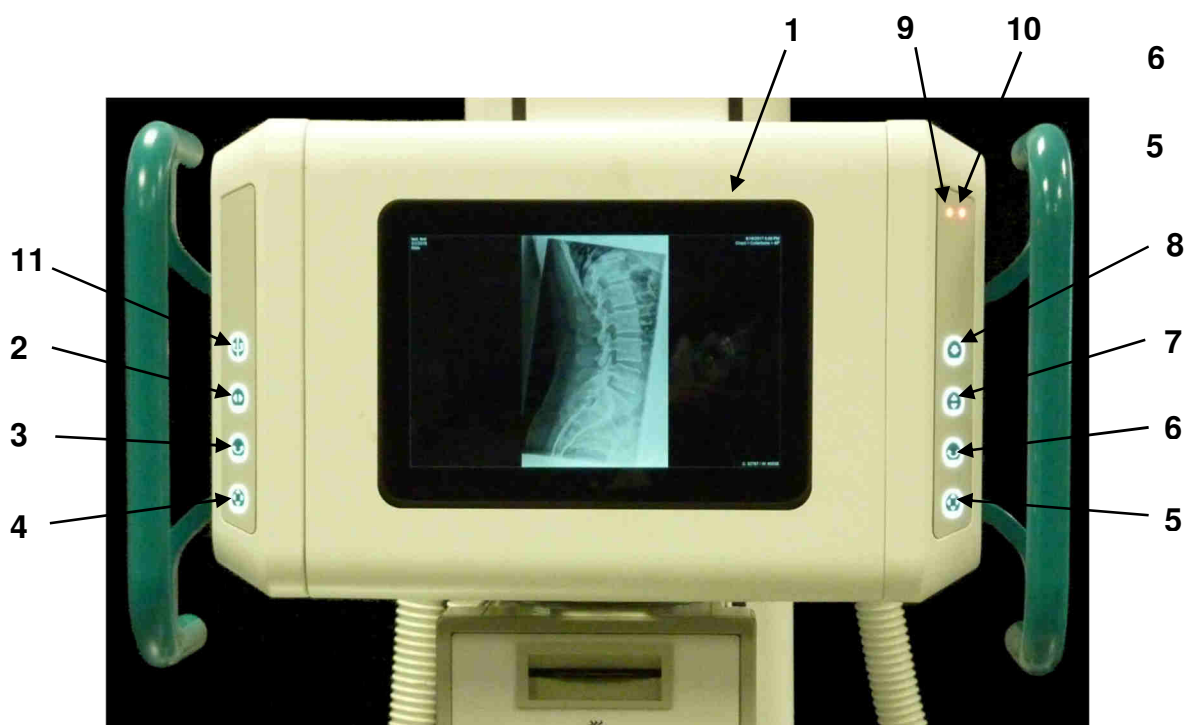

Operation is from the front (operating side) of the X-ray head.

If the operating unit is equipped with handles, the electromagnetic lock of one or more movements can be released by thumb pressure on the keys of the operating unit and the tube head can be brought into the desired position.

3.4.3 Foot pedal

To unlock the X-ray tube carrier, the foot lever (see Illustration Pos.1) must be operated downwards. Hold the foot lever in this position and turn the X-ray tube carrier a little in the desired direction. For further rotation, the foot lever does not have to be operated anymore. The detent in the new position centers itself.



NOTE

To rotate the X-ray column, the Buckywagen must be pushed out of the driver bracket of the X-ray column.



WARNING!

There is an increased risk of injury if the X-ray tube carrier is not engaged!



Detailed information please find in the accompanying Instructions for use PROGNOT SH.

3.5 Control elements and Display of collimator

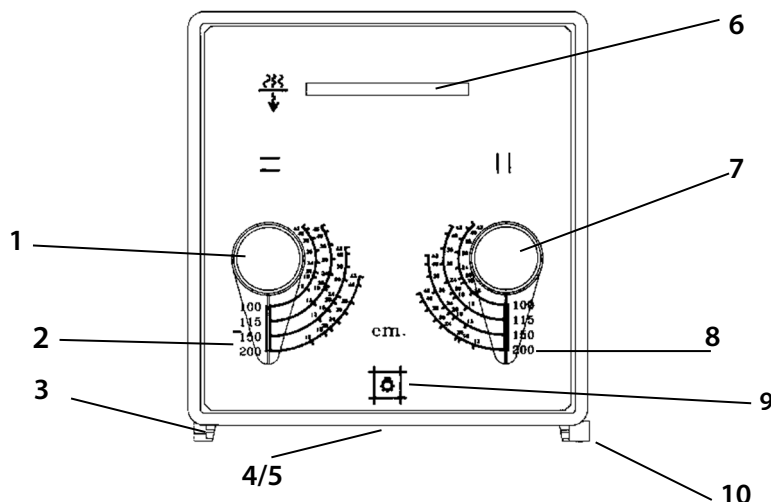

Figure collimator, may differ depending on the system.

Pos. 1 -> Collimator adjustment control; allows for manual opening and closing of collimator shutters (transversely to table top).

Pos. 2 -> Scales; indicate the opening of collimator shutters (transversely to table top).

Pos. 3 -> Accessory rails (can be used for measuring phantoms).

Pos. 4 -> Light resp. X-ray field; corresponding to opening of collimator shutters.

Pos. 5 -> Light centering device; allows centering of the X-ray tube assembly with the Bucky unit.

Pos. 6 -> Filter control for selection of additional filtration.

Pos. 7 -> Collimator adjustment control; allows for manual opening and closing of collimator shutter (longitudinally to table top).

Pos. 8 -> Scales; indicate the opening of collimator shutters (longitudinally to table top).

Pos. 9 -> Collimator light switch; turns on collimator light.

Pos. 10 -> Measuring tape.

Detailed information please find in the enclosed Instructions for use collimator.

3.6 Control elements and Display of X-ray tube

Detailed information please find in the enclosed Instructions for use of the X-ray tube.

3.7 Control elements and Display of X-ray generator

Detailed information please find in the enclosed Instructions for use of the X-ray generator.

3.8 Control elements of Bucky, Grid entity

Detailed information please find in the enclosed Instructions for use.

3.9 Control elements and Display of verticalX-ray system image receptor stand PROVERT

3.9.1 Vertical carriage

- 1 Brake release vertical movement Bucky
- 2 Switch on light field indicator of collimator*

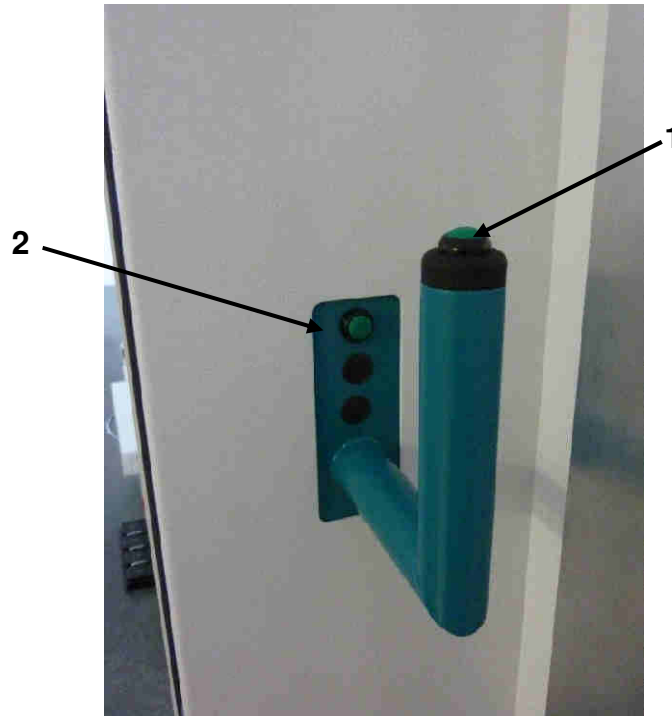

Detailed information please find in the enclosed Instructions for use of the PROVERT.

3.10 Control elements and device displays of RAPIXX system

Detailed information please find in the enclosed Instructions for use of the RAPIXX system.

3.11 Control elements and device displays of CONAXX 2

Detailed information please find in the enclosed Instructions for use of the CONAXX 2.

4 Handling / Operation

4.1 Requirements before and during Operation

It must be ensured that the principles of radiation protection are always observed (see chapter 2.1.6). It must be ensured that the surfaces in contact with patients (e.g. X-ray system table, cover image receptor stand) are disinfected before the X-ray examination of each patient (see chapter 5.3.2).

4.2 Operation of the X-ray system

4.2.1 Operation at the X-ray system table

4.2.1.1 Releasing the tabletop brake and positioning the tabletop



NOTE

Prior to patient positioning, the X-ray unit must be brought into the required exposure position.



WARNING!

The tabletop may only be locked when the tabletop is in the rest position, not while it is being moved.

1. Release the tabletop brakes by pressing the brake bar with your foot.
2. Move the floating tabletop to the desired position by hand while keeping the brake bar pressed.
3. When the tabletop is in the rest position, release the brake bar and the tabletop will be locked again by the brakes.

Tabletop displacement from the central position:

Transverse direction	± 150 mm
Longitudinal direction	± 330 mm (2m tabletop) ± 460 mm (2.26 m tabletop)

4.2.1.2 Position of patients on the tabletop

- Step on the brake release pedal bar.
- Move the tabletop into position for patients convenient getting on the tabletop.
- Release the brake release pedal bar.
- Assist the patient in getting on and lying down on the tabletop.
- Step on the brake release pedal bar and position the patient by moving the floating tabletop.

4.2.1.3 Setting the X-ray unit to the centre of the Bucky/Grid entity

- By pressing button 2 (fig. operating unit) release the brake for the longitudinal movement of the tube stand.
- Grasp the two handles of the command arm.
- Move the tube stand in the longitudinal direction to the X-ray table until the Bucky/Grid entity snaps into the safety coupling.



WARNING!

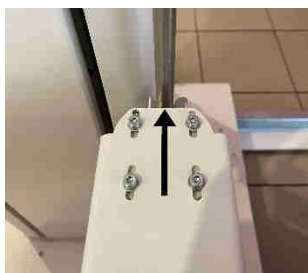

The Bucky catch must engage exactly in the bracket on the tube stand to ensure that the image receiver is positioned to the middle of the X-ray tube unit. For correct central positioning, the arrow shown must point to the bracket.

- When correctly centered, the laser line of the collimator points exactly over the engraved triangular tip of the Bucky/Grid entity's clamping device (see figure). This is not the case with an oblique position of the collimator.

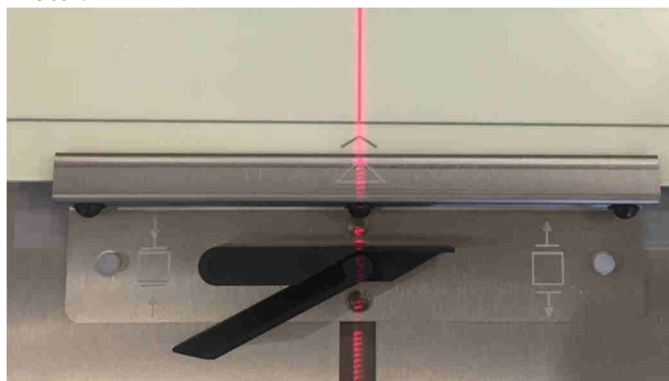

4.2.1.4 Inserting an image receptor into the cassette tray

- An image receptor (cassette/detector) may be placed into the cassette tray, when the X-ray tube assembly is positioned.
- Pull out the cassette tray by its handle from the Bucky unit until it hits the forward stop.
- The cassette clamps centre the image receptor transversely within the cassette tray. Rotate its latch counter-clockwise to unlock it.
- Open the cassette clamps far enough to insert an image receptor of the desired size.
- At table Bucky insert the image receptor, with its transverse centreline aligned with the notch in the cassette clamps or by engaging the cassette positioner in the size of the image receptor corresponding detent (13 cm, 18 cm, 24 cm, 30 cm, 35 cm, 40 cm or 43 cm), push the cartridge to the cassette positioner.
- Push the cassette clamps against the image receptor and rotate the latch into the locked position.
- Push the cassette tray fully into the Bucky unit.

4.2.1.5 Adjusting the focus-film distance (FFD)

- Set the X-ray unit with a tape measure at the collimator or the display on the tube to the desired focus-film distance (FFD).
- Press the button 7 (Figure operating unit) off the brake to adjust the height of the X-ray unit.

4.2.1.6 Adjusting the light resp. X-ray field

- Press the collimator light switch (button 9, figure collimator) to turn on the collimator light, and view the opening of the collimator shutter in both axes relative to the image receptor size scales.
- Several FFD scale (adjuster 1 and 7, figure collimator) are provided to indicate the correct settings of the collimator adjustment controls for the collimator shutters for several image receptor sizes so that the light beam and the X-ray field can be limited to the desired image receptor size in both

axes. Adjust the image receptor size as required using the collimator adjustment controls. Reduce shutter openings to objects size for better image quality.

4.2.1.7 Exposure preparation / exposure release

- At the X-ray generator operator console control panel, select the desired X-ray equipment (Bucky table with Bucky unit) by selecting the corresponding X-ray equipment/exposure technique switch.
- Press the desired Anatomically Programmed Radiography (APR) switch or manually select the desired exposure factors. Start the exposure by pressing the switches for exposure preparation/exposure release.

4.2.1.8 On-table exposures

- Place an image receptor to the desired position on the tabletop.
- Move X-ray tube to the desired position and adjust FFD.
- Press the collimator light switch (button 9, figure collimator) to turn on the collimator light, and view the opening of the collimator shutters in both axes relative to the image receptor and object size.
- Place the object on the image receptor.
- Adjust the light field with the adjuster 1 and 7 (figure Collimator) onto the size of the used image receptor. So the radiation field will be limited to the size of the image receptor.
- At the X-ray generator operator console control panel, select the desired X-ray equipment (Bucky table without Bucky unit) by selecting the corresponding X-ray equipment/exposure technique switch.
- Press the desired Anatomically Programmed Radiography (APR) switch or manually select the desired exposure factors. Start the exposure by pressing the switches for exposure preparation and exposure release.

4.2.1.9 Exposures with the lateral detector holder (optional)



- Move the tube column beside the table, until the tube column is released from the Bucky actuation adapter.



CAUTION!

To avoid damage, the tube column may only be rotated when it is outside the Bucky actuation adapter.

- Press the foot pedal on the tube column wagon to rotate the whole tube column to the left or right side



- Turn the tube head in direction of the lateral detector holder
- Push the tube column to the lateral detector holder
- Adjust the height of the tube arm or of the table that the light field is aligned to the panel

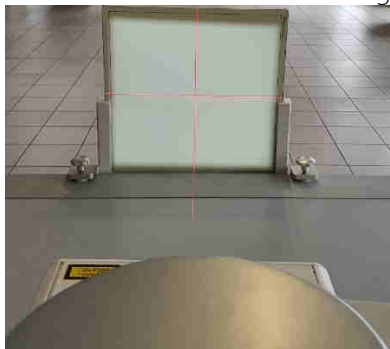

4.2.2 Operation at X-ray system image receptor stand PROVERT

4.2.2.1 Adjustment of the X-ray unit to the mid of the Bucky/Grid entity of the image receptor stand (vertical centre beam)

- By pressing button 3 or 6 (figure operating unit) the brake for the rotation of the collimator will be released.
- Swing the X-ray unit to the X-ray system image receptor stand.
- Set the Bucky, Grid entity on the vertical stand to the size of the patient, see figure vertical carriage.
- When correctly centered, the laser line of the collimator points exactly over the engraved triangular tip of the Bucky/Grid entity's clamping device (see figure). This is not the case with an oblique position of the collimator.

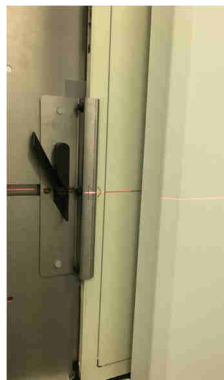

4.2.2.2 Adjustment of the source to image-receptor distance (SID)

- Release the longitudinal movement brake of the column by pressing button 2 (figure control handle) and adjust the source to image-receptor distance (SID) which will be used for the exposure. Notice the focus area of the scanning unit, Bucky and Grid entity. Those settings have to be done with the measuring tape inside the collimator or with the markings on the upper guidance of the column.

4.2.2.3 Adjustment of the light-/ radiation field

- By using button 7 (figure operating unit) the button of the brake for adjusting the height will be released
- Set the collimator to the requested height and align it to the Bucky by using the light-beam localizer 4 (figure control handle).
- Release Button 7 (figure operating unit) to activate the height-adjustable brake for the collimator.
- By using button 9 (figure collimator) the light-beam will be activated to control the vent of the collimator to the used image receptor.

- With the adjuster 1 and 7 (figure collimator) set the lamellas of the collimator to the size of the used image receptor. The settings will be done on the scale 2 and 8 (figure collimator) to the according source-image distance (SID). So the light-/ radiation field is limited to the according image receptor.

4.2.2.4 Exposure preparation/ release

- Select the used device on the console of the generator (vertical-grid recording device).
- Select the requested organ program or the requested exposure details and start the exposure by using the control element for exposure preparation/ release.

4.3 Operation X-ray system table PROGNOST F

Detailed information please find in the enclosed Instructions for use of the PROGNOST F.

4.4 Operation collimator

Detailed information please find in the enclosed Instructions for use of the collimator.

4.5 Operation X-ray tube



NOTE

The X-ray tube must be warmed up every day to prolong the life of the X-ray tube and to prevent flashovers. If you do not have the initial preparation procedure recommended by the X-ray tube manufacturer, proceed as follows:

Set generator: Large focus, 200 mA, 40 mAS.

Take 8 exposures. Start at 50 kV and increase in 10 kV steps to 120 kV (expose every 30 seconds, otherwise a flashover can occur in the tube).

See also the instruction for use of the respective generator and the CONAXX 2 instructions for use.

Detailed information please find in the enclosed Instructions for use of the X-ray tube.

4.6 Operation X-ray generator

Detailed information please find in the enclosed Instructions for use of the generator.

4.7 Operation Bucky, Grid entity

Detailed information please find in the enclosed Instructions for use.

4.8 Operation vertical X-ray system image receptor stand PROVERT

Detailed information please find in the enclosed Instructions for use PROVERT.

4.9 Operation RAPIXX system

Detailed information please find in the enclosed Instructions for use.

4.10 Operation Software

Detailed information please find in the enclosed installation- and Instructions for use CONAXX 2.

4.11 Function of the PRS 500 F

4.11.1 Switching the PRS 500 F on and off

Switching on the PRS 500 F is switched on via the console of the generator. All system components are supplied with voltage via the generator. If the system contains a Power Box, the power is supplied via the Power Box.

When the generator or Power Box is powered up using the switch-on button, a self-test runs on the generator and the control desk. After successful completion of the self-test, the parameters are displayed.

**ATTENTION!**

Specially for the TOUCH option: The system is only switched off when the touch display is completely shut down. A system restart is only possible after the touch display has been shut down completely. Otherwise the touch display will not start.

4.12 Automatic Exposure Control

If the PRS 500 F is operated with an automatic exposure control, the functionality can be checked as follows:

Place a phantom or any other weakening object (not lead) in the beam path. Select the measurement chamber field to be checked and trigger the exposure. If this works properly, the measured value is displayed. Repeat this procedure for all existing measuring chamber fields. If an error message is displayed during this test, please contact PROTEC service department or a service company authorized by them immediately.

5 Safety and Maintenance



WARNING!

Caution, risk of electric shock!

Switch off the X-ray system before cleaning or disinfecting. This disconnects the X-ray system from the power source and avoids the risk of electric shock.

5.1 Introduction

In this chapter you will find information about safety and maintenance that are necessary to ensure the correct and reliable function of the device after installation.

5.2 Reusability

The PRS 500 F can be reused without any special preparation procedures.

However, it must be ensured that the surfaces in contact with patients are disinfected before the X-ray examination of each patient (see also chapter 4.1).

The PRS 500 F must no longer be used with patients if it shows signs of wear (e.g. metal abrasion, wear of insulations) or dangerous technical defects (e.g. torn cable, bent parts) or if the resulting image quality (e.g. artifacts in the image) is insufficient.

In this case, please contact PROTEC service department or a service company authorized by them immediately.

5.3 Cleaning and Disinfection



NOTE

Caution
Possible material changes!



WARNING!

Make sure that no liquid enters the interior of the housing during cleaning and disinfection in order to prevent electrical short circuits and/or corrosion.



NOTE

For X-ray systems with included RAPIXX set, detailed information on cleaning and disinfecting the RAPIXX set can be found in the enclosed RAPIXX instructions for use, chapter 5.3.

5.3.1 Cleaning

The cleaning of the PRS 500 F is very easy due to the very good quality surface coating. This is usually only done with a dry cloth.

Do not use corrosive, dissolving or abrasive cleaning agents, which could damage the device surfaces or the coating.

Clean the device surfaces and painted parts with a damp cloth and a mild to slightly alkaline cleaning solution (e.g. RBS® Neutral T) and wipe dry.

Chrome parts may only be wiped with a dry woollen cloth.

5.3.2 Disinfection

The disinfection must be performed in accordance with the current applicable legal requirements and guidelines corresponding for disinfection and explosion protection.

For disinfection of surfaces in contact with patients, we recommend commercially available medical rapid disinfection wipes (e.g. Dr. Schumacher Descosept Sensitive Wipes).

All mechanical parts of the PRS 500 F, including accessories, may only be cleaned with a wipe disinfection with suitable surface disinfectants (e.g. Melsept® SF, 15 min. application time at 2% concentration). The information provided by the disinfectant manufacturer on concentrations and application times must be observed.

**WARNING!**

No highly flammable disinfectants may be used! For safety reasons, spray disinfection must not be carried out, as the spray mist could penetrate the device and cause short circuits or corrosion.

If disinfectants are used that can form explosive gas mixtures, the device may only be switched on again when the gas mixtures have evaporated!

5.4 Inspection and maintenance

**WARNING!**

No maintenance or repair work may be performed while the PRS 500 F is being used with a patient!

All maintenance and repair work may only be performed by personnel trained or authorized by PROTEC.

5.4.1 Daily Monitoring before and during the Examination operation

See instructions for use of the associated system components.

Wear parts must be replaced with original components.

5.4.2 Regular Monitoring

See Instructions for use of the associated system components.

Wear parts must be replaced with original components.

5.4.3 Maintenance

The required maintenance must be carried out by PROTEC service department or a service company authorized by them in order to ensure the safe and reliable functionality of the device. The maintenance intervals depend on the frequency of use. The required specifications can be found in the corresponding Technical Description in chapter 3 *Maintenance and Safety Inspection*.

In the event that the planned maintenance is not carried out, PROTEC X-ray Systems GmbH assumes no liability whatsoever for damage to the user and third parties if damage results from inadequate or not carried out maintenance.

Prior to the examination operation, the user must satisfy himself that all appliances listed in the operating instructions and serving safety are in working order and that the product is ready for operation.

See the technical descriptions of the X-ray system and the associated system components.

Wear parts must be replaced with original components.

5.4.4 Warranty

**NOTE**

You will find the current warranty conditions in your order documents or in the price list valid at the time of purchase.

Repairs and spare parts in the event of improper use are also excluded.
Warranty work may only be carried out by trained specialists.

5.4.5 Product Service Life

The PRS 500 F is designed for a service life of 10 years when used in accordance with the specifications and regular maintenance by PROTEC service department or a service company authorized by them. After the product has reached the end of its service life, further use is at your own risk.

5.4.6 Further Information

Detailed information to the individual chapters and for a safe operation, transport or storage can be found in the Technical Description of the system and of the individual components.

5.4.7 Applied Parts and parts which get handled like an application part

Part	Definition
	Applied part or part that is treated like an applied part but is not defined as an applied part.
Tabletop	Applied part
Cover verticalX-ray system image receptor stand	Applied part
Detector	Applied part
Housing parts PROGNOST F	Part, get handled like an application part
Optional accessory	
Patient extending handle (<i>optional</i> , mounted at the verticalX-ray system image receptor stand)	Part, get handled like an application part
Patient handle (<i>optional</i> , mounted at the X-ray system table)	Part, get handled like an application part
Compression Band (<i>optional</i>)	Part, get handled like an application part
Mattress (<i>optional</i>)	Part, get handled like an application part

5.4.8 Disposal



The PRS 500 F contains various plastics, oil and heavy metal. When disposing exchange and spare parts, or if necessary, the entire device, the valid rules and regulations must be observed. Please contact your contractual partner or service company or commission a company specialized in disposing the respective components.

6 Power Supply



NOTE

The X-ray system requires the following power supply depending on the generator (see table „Power Supply Generator“).

Generator Type	Output Power	Line Voltage	Phases	Line Frequency	Line Resistance	Fuse
HFe 501	50 kW	400 VAC	3 phases	50/60 Hz	0.3Ω	35 A time delay
HFe 601	65 kW	400 VAC	3 phases	50/60 Hz	0.2Ω	50 A time delay
HFe 801	80 kW	400 VAC	3 phases	50/60 Hz	0.12Ω	50 A time delay
Venus-32-R 1-ph	32 kW	220 VAC 230 VAC	1 phase	50/60 Hz	0.5 Ω	16 A time delay
Venus-32-R 3-ph	32 kW	380 VAC 400 VAC	3 phases	50/60 Hz	0.27 Ω 0.29 Ω	63 A time delay
Venus-50-R 1-ph	50 kW	220 VAC 230 VAC	1 phase	50/60 Hz	0.5 Ω	16 A time delay
Venus-50-R 3-ph	50 kW	380 VAC 400 VAC	3 phases	50/60 Hz	0.17 Ω	63 A time delay
Polydoros RFX 55	55 kW	380 VAC 400 VAC 440 VAC 480 VAC	3 phases	50/60 Hz	0.15 Ω 0.17 Ω 0.20 Ω 0.24 Ω	50 A gG
Polydoros RFX 65	65 kW	380 VAC 400 VAC 440 VAC 480 VAC	3 phases	50/60 Hz	0.15 Ω 0.17 Ω 0.20 Ω 0.24 Ω	50 A gG
Polydoros RFX 80	80 kW	380 VAC 400 VAC 440 VAC 480 VAC	3 phases	50/60 Hz	0.10 Ω 0.11 Ω 0.14 Ω 0.16 Ω	50 A gG
CMP 200 DR 50	50 kW	400 VAC 480 VAC	3 phases	50/60 Hz	0.17 Ω 0.24 Ω	60 A time delay
CMP 200 DR 65	65 kW	400 VAC 480 VAC	3 phases	50/60 Hz	0.13 Ω 0.19 Ω	60 A fast acting
CMP 200 DR 80	80 kW	400 VAC 480 VAC	3 phases	50/60 Hz	0.10 Ω 0.15 Ω	60 A fast acting

Table Power Supply Generator



WARNING!

To avoid the risk of an electric shock, this device may only be connected to a supply network with a protective earth conductor.

6.1 Electromagnetic Compatibility (EMC) after EN 60601-1-2



CAUTION!

As a medical electrical device, the PRS 500 F is subject to special precautionary measures regarding EMC and must be installed and commissioned in accordance with the EMC information contained in the accompanying documents.



CAUTION!

Portable RF communication devices (radio devices) should not be used closer than 30 cm (12 in) to the marked parts and cables of the PRS 500 F. Failure to observe can lead to a reduction in the performance characteristics of the device.



CAUTION!

The X-Ray generator integrated into the PRS 500 F sends out electromagnetic waves during operation, which could interfere with or be interfered by other devices.

For EMC guidelines and manufacturer's declaration in accordance with EN 60601-1-2, see the separate instructions for use for the corresponding X-ray generator.

6.1.1 Guidelines and Manufacturer's Declaration – Electromagnetic interference

The PRS 500 F is intended for use in the electromagnetic environment specified below. The customer or the Operator of the radiographic system should assure that it is used in such an environment.

Measurement interference	Compliance	Electromagnetic Environment
RF emissions CISPR 11	Group 1	The X-ray component uses RF energy exclusively for its internal function. As a result, its RF emissions are very low and it is unlikely that nearby electronic devices will be influenced.
RF emissions CISPR 11	Class A	The device is suitable for use in facilities other than residential areas and those that are directly connected to the public supply network, which also supplies buildings that are used for residential purposes, provided the following warning is observed:
Harmonic emissions EN 61000-3-2	Class A	
Voltage fluctuations/ flicker emissions EN 61000-3-3	compliant	Warning: This device is intended for use by medical professionals only. This is a class A device according to CISPR 11. This device can cause radio interference in residential areas, in which case it must be necessary to take appropriate remedial measures such as new alignment, rearrangement or shielding of the device or filtering of the connection to the location.

Immunity Test	EN 60601-1-2 Test Level	Compliance Level	Electromagnetic Environment - Guidance
Electrostatic discharge (ESD) EN 61000-4-2	± 8 kV contact discharge ± 2 kV, ± 4 kV, ± 8 kV, ± 15 kV air discharge	± 8 kV contact discharge ± 2 kV, ± 4 kV, ± 8 kV, ± 15 kV air discharge	Floors should be made of wood, concrete or ceramic tiles. If the floor is covered with synthetic material, the relative humidity must be at least 30%.
Fast transient electrical disturbance variables / burst EN 61000-4-4	± 2 kV for power supply lines ± 1 kV for input/output lines	± 2 kV for power supply lines ± 1 kV for input/output lines	The quality of the supply voltage should correspond to that of a typical business or hospital environment.
Surges EN 61000-4-5	± 0,5 kV ± 1 kV ± 2 kV	± 0,5 kV ± 1 kV ± 2 kV	The quality of the supply voltage should be that of a typical commercial or hospital environment.

Magnetic field at the supply frequency (50/60 Hz) EN 61000-4-8	30 A/m 50/60 Hz	30 A/m 50/60 Hz	Magnetic fields at the mains frequency should correspond to the typical values found in a business and hospital environment.
Voltage dips, short interruptions and fluctuations in the supply voltage EN 61000-4-11	<5 % UT (>95 % dip in UT) for ½ cycle <5 % UT (>95 % dip in UT) for 1 cycle 70 % UT (30 % dip in UT) for 25/30 cycles <5 % UT (>95 % dip in UT) for 5/6s	<5 % UT (>95 % dip in UT) for ½ cycle <5 % UT (>95 % dip in UT) for 1 cycle 70 % UT (30 % dip in UT) for 25/30 cycles <5 % UT (>95 % dip in UT) for 5/6s	The quality of the supply voltage should correspond to that of a typical business or hospital environment. If the user of the device demands continued operation even if there are interruptions in the energy supply, it is recommended that the device be fed from an uninterruptible power supply or battery.
Conducted disturbances induced by RF fields EN 61000-4-6	3 V/m 1 kHz 80% AM 150 kHz bis 80 MHz	3 V/m	
Radiated RF disturbances EN 61000-4-3	3 V/m 1kHz 80% AM 80 MHz to 2.7 GHz	3 V/m	See table below

NOTE: These guidelines may not apply in all situations. Electromagnetic propagation is affected by absorption and reflection from structure, objects and people.

Test Frequency in MHz	Frequency Band in MHz	Service in MHz	Modulation	Immunity Testing Level in V/m
385	380 - 390	TETRA 400	Pulse modulation: 18 Hz	27
450	430 – 470	GMRS 460, FRS 480	FM ±5 kHz Deviation 1 kHz Sine	28
710 745 780	704 – 787	LTE Band 13, 17	Pulse modulation: 217 Hz	9
810 870 930	800 – 960	GSM 800/900, TETRA 800, iDEN 820, CDMA 850, LTE Band 5	Pulse modulation: 18 Hz	28
1720 1845 1970	1700 - 1990	GSM 1800, CDMA 1900, GSM 1900, DECT, LTE Band 1, 3, 4, 25, UMTS	Pulse modulation: 217 Hz	28
2450	2400 – 2570	Bluetooth, WLAN, 802.11 b/g/n,	Pulse modulation: 217 Hz	28

		RFID 2450, LTE Band 7		
5240 5500 5785	5100 - 5800	WLAN, 802.11 a/n	Pulse modulation: 217 Hz	9

7 Technical Data

7.1 Dimensions

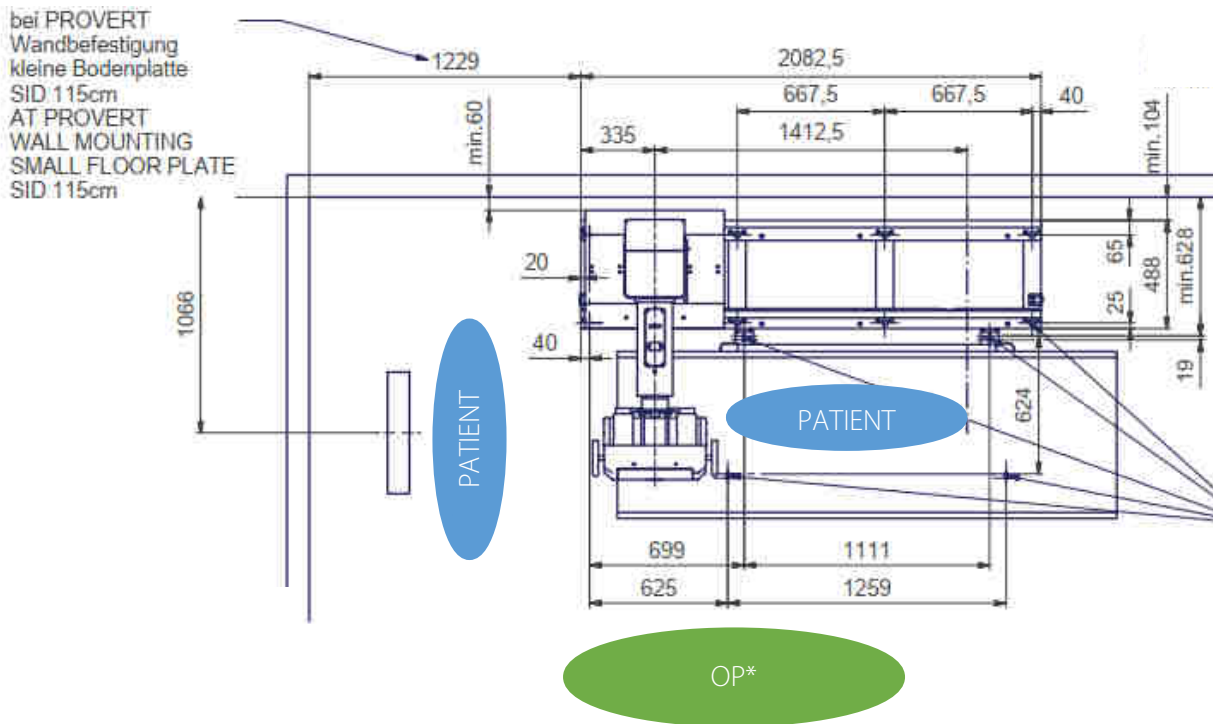
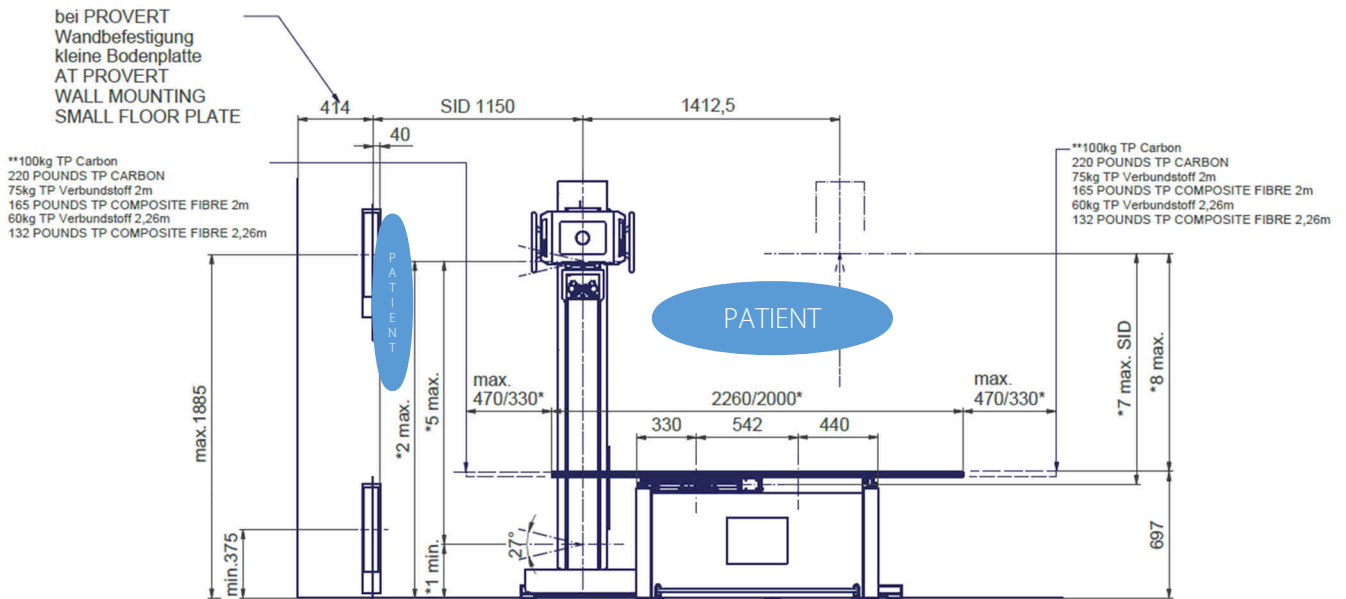

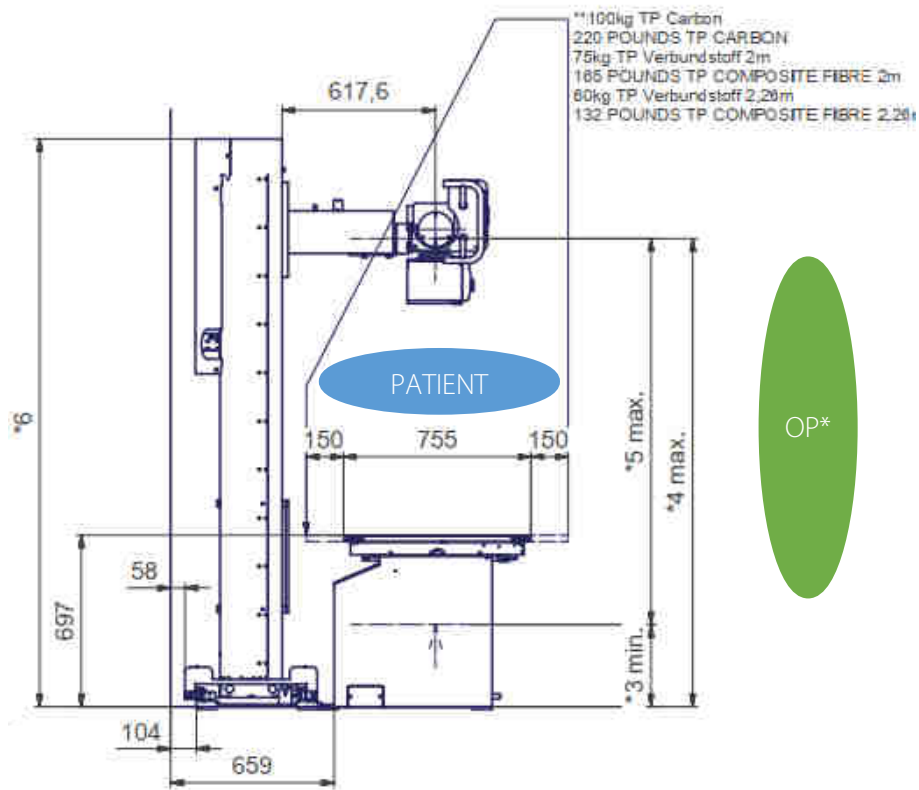

*OP - Anwender

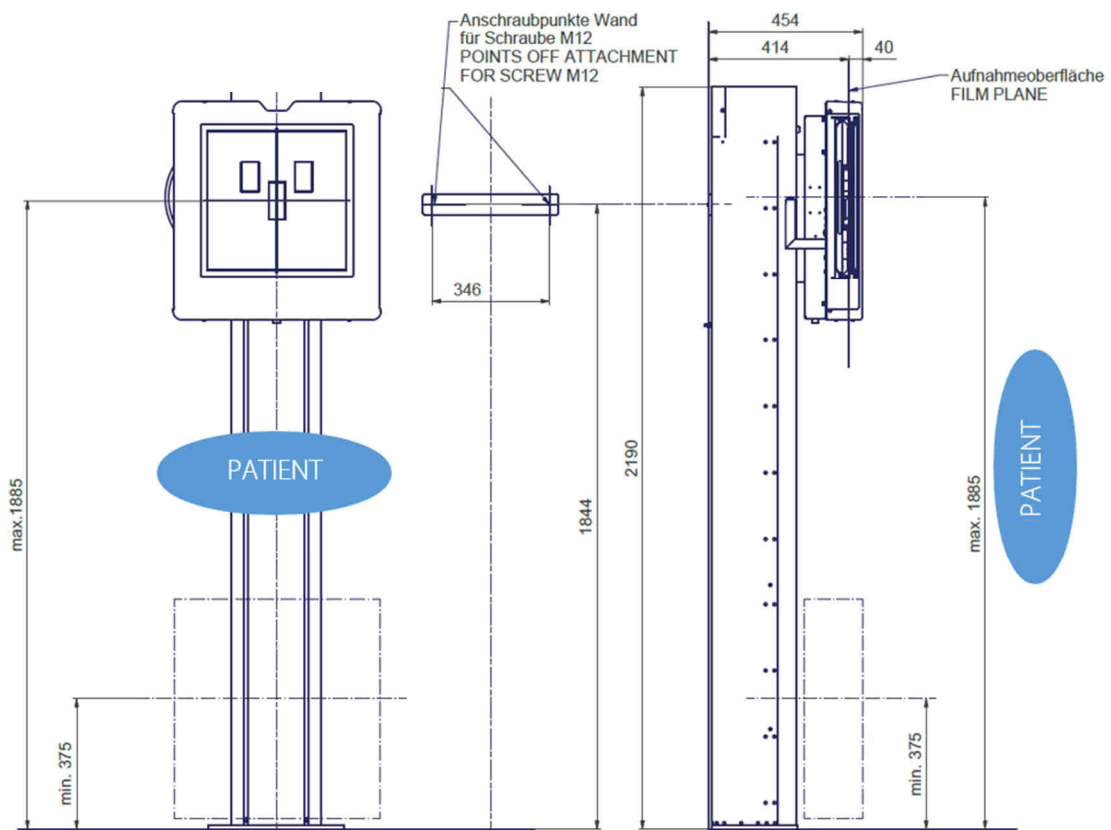

7.2 X-ray system table PROGNOST F

Table top dimension (L x B):	2260 mm x 755 mm, standard 2000 mm x 755 mm, optional
Patient load, max	230 kg TP composite fibre (standard) 250 kg TP carbon fibre
Table top height:	697mm
Table top movement, transvers (from the mid-position):	± 150 mm
Table top movement longitudinal (from the mid-position):	± 470 mm (TP 2260mm) / ± 330mm (TP 2000mm)

The brakes of the tabletop are used electro-mechanic.

Detailed information please find in the enclosed Instructions for use, Technical Description of the PROGNOST F.

7.3 Bucky, Grid entity

Longitudinal travel:	542 mm
Min. distance Bucky center to table head end:	330 mm
Min. distance Bucky center to table foot end:	440 mm
Table top - film-distance:	67 mm

The Bucky, Grid entity and the measure chambers are connected to the generator.

Detailed information please find in the enclosed Instructions for use, Technical Description of the Bucky, Grid entity.

7.4 X-ray Tube Support Stand

dimensions in mm		design PROGNOST SH			
		standard	standard with telescopic arm	rotation X-ray column	rotation X-ray column with telescopic arm
1*	Min. floor distance (vertical travel @horizontal X-ray beam)	297	302	309	315
2*	Max. floor distance (vertical travel @horizontal X-ray beam)	1878	1883	1890	1896
3*	Min. floor focus distance (X-ray beam to floor)	304	310	317	322
4*	Max. floor focus distance (X-ray beam to floor)	1885	1891	1898	1903
5*	Travel range X-ray arm - vertical	1581			
6*	Max. height X-ray column	2297,5		2353	
7*	Max. focal spot vertical – film distance (standard PROGNOST F):	1242	1248	1255	1260
8*	Max. focal spot vertical – table top distance (standard PROGNOST F):	1188	1194	1201	1206
	X-ray tube support, floor stand longitudinal travel	1412.5			
	X-ray tube support, floor stand longitudinal travel, with short floor rail extension	2078.5			
	X-ray tube support, floor stand longitudinal travel, with long floor rail extension	3495			
	Extension telescopic X-ray arm (optional)	-	+230	-	+230
	Detents X-ray tube assembly around horizontal support arm	- 90°, 0°, + 90°, 180°			
	Angulation X-ray tube assembly around horizontal support arm	+/- 180°			
	Locking X-ray tube unit around the horizontal tube column	-		- 90°, 0°, + 90°, 180°	
	Rotation X-ray tube unit around the horizontal tube column	-		+/- 180°	

Detailed information please find in the enclosed Instructions for use, Technical Description of the PROGNOST SH.

7.5 Image Receptor Stand

Standard

Column height: 2190mm

Vertical shift film center: 375mm - 1885mm

The Bucky, Grid entity and the measure chambers are connected to the generator.

Detailed information please find in the enclosed Instructions for use, Technical Description of the PROVERT.

7.6 Attenuation Equivalent



WARNING!

The PRS 500 F can be supplied with different options for the X-ray cassette holders. The device attenuation factor must be determined during the acceptance test. The variable components such as the X-ray tube, collimator, anti-scatter grid, measuring chamber, dose area product meter, tabletop, etc. change the factor individually. The attenuation values of the components can be taken from the corresponding accompanying papers. The determination of the device attenuation factor must be carried out according to the specialist regulations. If the prescribed values cannot be met, this must be reported to PROTEC immediately.

If additional components (positioning aids, etc.) are placed in the beam path, this will have a negative effect on the quality of the X-ray exposure.

The tabletop is defined as an applied part.

The aluminium attenuation equivalent of the tabletop is typically 0.7 mm Al and <0.8 mm Al for carbon; 0.85 mm Al for composite material according to EN 60601-1-3 at 100 kV and a first half-value layer thickness of 3.6 mm Al and typically 0.6 mm Al and <0.8 mm Al according to 21CFR § 1020.30 (m) at 100 kV and a first half-value layer thickness of 3.6 mm Al.

The Bucky cover of the image receptor stand is defined as an applied part.

The aluminium attenuation equivalent of the cover is typically 0.4 mm Al and <0.5 mm Al according to EN 60601-1-3 at 100kV and a first half-value layer thickness of 3.6 mm Al.

7.6.1 Protection Art and Protection Class

The PRS 500 F corresponds to protection class 1 and contains applied parts type B (according to EN 60601-1).

7.7 Automatic Cut-off Dose

7.7.1 Analogue System

The automatic cut-off dose is 2.5 µGy.

7.7.2 Digital System

7.7.3 Digital System

The automatic cut-off dose depends on the detector.

For RAPIXX systems see instructions for use of the corresponding RAPIXX system (Chapter 3.2; 3.3).

7.8 Environmental Conditions

7.8.1 Environmental conditions during operation

Ambient Temperature + 10°C to + 40°C

Relative humidity 30% to 75% (non-condensing)













Atmospheric pressure 700 hPa to 1060hPa

7.8.2 Environmental Conditions for Shipping and Storage

Ambient Temperature	- 10°C to + 70°C
Relative humidity	10% to 95% (non-condensing)
Atmospheric pressure	500 hPa to 1060hPa

8 Description of symbols, labels and abbreviations

8.1 Symbols

	Atmospheric pressure limit
	Temperature limit
	Humidity limit
	Keep dry
	Fragile, handle with care
	This way up
	Caution, note warning notice and safety instructions
	Refer to Instructions for use
CE 0297	CE-Mark
	Manufacturer
MD	Medical Device
REF	Order reference
SN	Serial number
UDI	Unique Device Identification
	Production date
	Classification according to EN 60601-1 (Type B)
 www.protect-med.com/download	This symbol indicates the need to observe the instructions for use. This is provided in an electronic format (eIFU) on our website.
	Disposal instructions; WEEE (Waste of Electrical and Electronic Equipment)

	Protective earthing
	Caution: pinch-/crushing hazard for hands and fingers
	Caution: pinch-/ crushing hazard of feet
	Climbing forbidden
	Attention: Electrostatic sensitive devices
	Do not exceed the maximum indicated weight
	Do not exceed the maximum indicated weight
	Horizontal movement of the X-ray tube stand
	Vertical movement of the X-ray tube arm
	Rotation of the X-ray tube assembly
	Horizontal movement of the X-ray tube stand and vertical movement of the X-ray tube arm
	Transversal movement of the X-ray tube arm (optional)
	Electrical release for rotating the X-ray tube stand by $\pm 180^\circ$ (optional)

8.2 Identification label

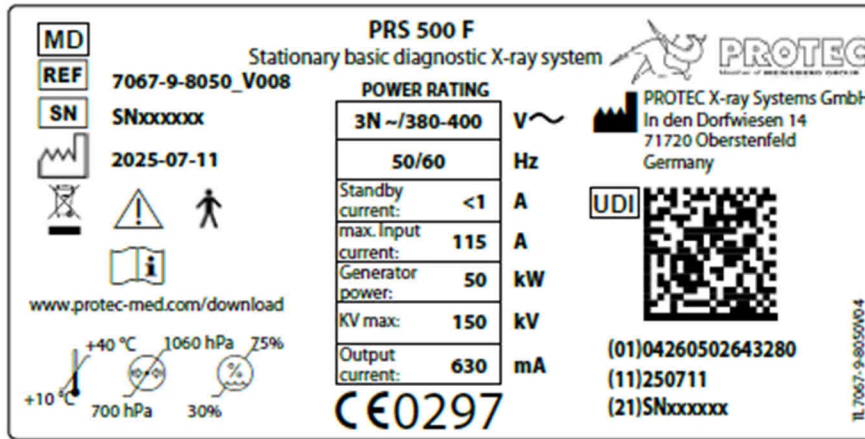

Exemplary for PRS 500 F with X-ray generator 50 kW

8.3 Labels

Labels on the side of the tabletop

Carbon tabletop

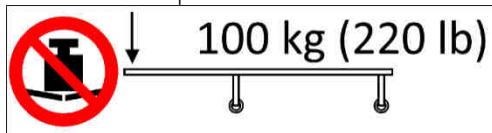

Composite-fibre tabletop 200cm

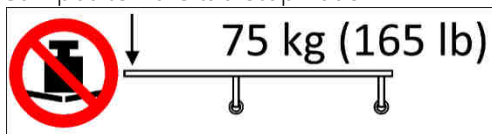

Composite-fibre tabletop 226cm

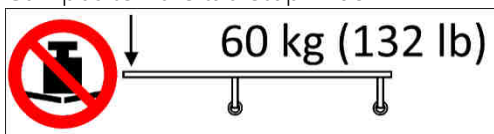

Labels on top of the tabletop

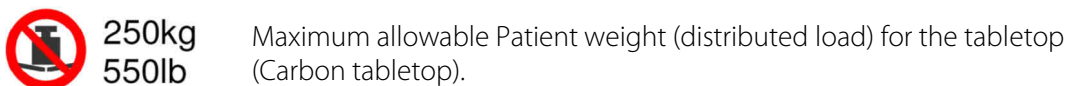
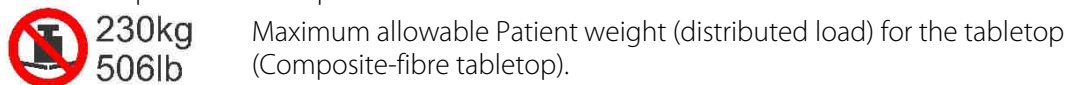

Labels on top of the tabletop and/or tubearm



Caution: Possible pinch-/crushing hazard for the hands and fingers while moving the tabletop, table and or X-ray tube assembly unit.

Labels on the X-ray system tube support, floor stand and column X-ray system image receptor stand



Label on the front plate x-ray system table



Company label

8.4 Position symbols and labels

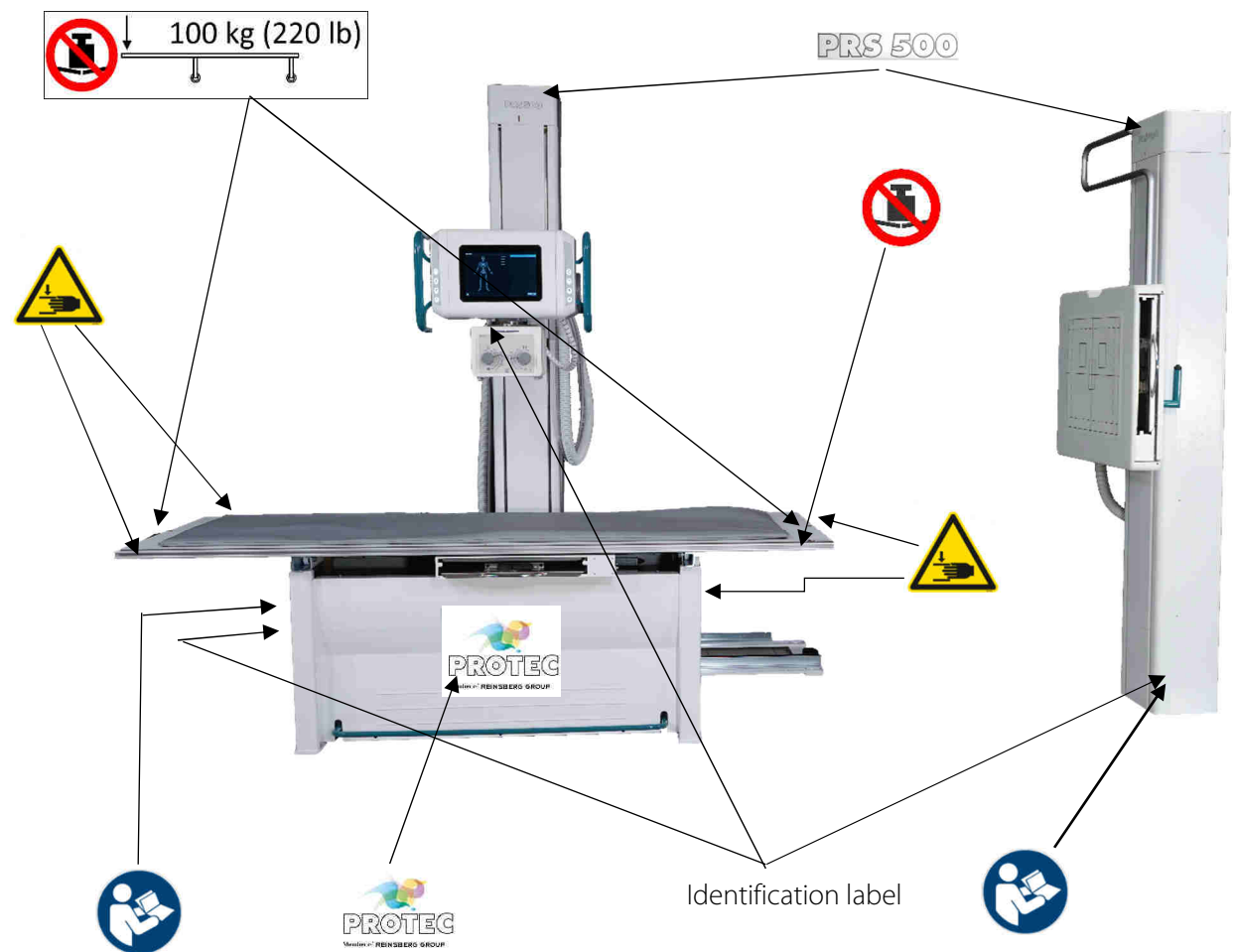
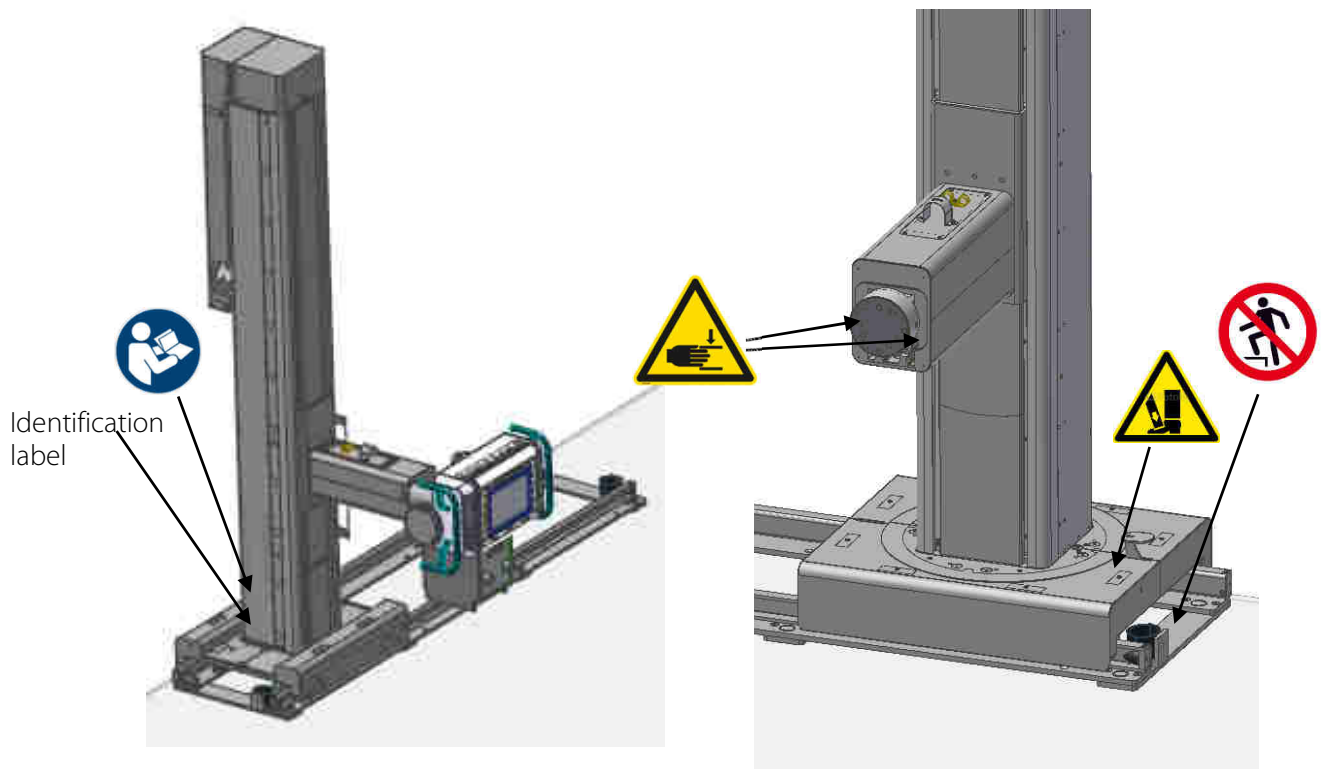

8.5 Abbreviations

mm	Millimetres
cm	Centimetres
kg	Kilogram
°C	Degree -Celsius
hPa	Hectopascal
DIN	German Industry Standard
EN	European Standard
CE	CE-Mark
Hz	Hertz
ED	Duty cycle
A	Ampere
SN	Serial number
VAC	Volt (AC voltage)
kW	Kilowatt